

RATTLER V³ LRF

THERMAL IMAGING RIFLE SCOPE
WITH LASER RANGEFINDER

USER MANUAL

© 2025 AGM Global Vision, LLC. All rights reserved.

This documentation is subject to change without notice.

No parts of this manual, in whole or in part, may be copied, photocopied, translated, or transmitted by any electronic medium or in machine-readable form without the prior written permission of AGM Global Vision, LLC.

If you have questions that are not covered in this manual, or need service, contact AGM Global Vision customer support for additional information prior to returning a product.

AGM Global Vision, LLC

2407 E Interstate 30, Suite 100

Grand Prairie, TX 75050

Tel. 928.333.4300

support@agmglobalvision.com

www.agmglobalvision.com

EXPORT INFORMATION

Buyer acknowledges that all products supplied by AGM Global Vision, LLC are subject to U.S. export control laws, including, but not limited to, the Export Administration Regulations, the International Traffic in Arms Regulations, the International Economic Emergency Powers Act, and various U.S. embargoes and sanctions. AGM Global Vision products may not be exported, re-exported, or transferred contrary to U.S. export control laws. In particular, AGM Global Vision products may not be exported, re-exported, or transferred to prohibited countries, individuals, organizations, or entities, including but not limited to those individuals and entities listed on the List of Specially Designated Nationals and Blocked Persons administered or maintained by the U.S. Office of Foreign Assets Control ("OFAC"), the various lists maintained by the Bureau of Industry and Security of the Department of Commerce, and the U.S. State Department and Buyer represents and warrants that neither Buyer nor any of its officers, directors, or employees are on such lists. Distribution or resale by Buyer to such countries, individuals, organizations, or entities is expressly prohibited. Buyer has and will maintain a positive process to ensure compliance with this Section.

FCC INFORMATION

Please note that changes or modification not expressly approved by the party responsible for compliance could void the user's authority to operate the equipment.

This equipment complies with FCC/IC RSS-102 radiation exposure limits set forth for an uncontrolled environment.



FCC compliance: This product has been tested and found to comply with the limits for a Class B digital device, pursuant to Part 15 of the FCC Rules. These limits are designed to provide reasonable protection against harmful interference in a residential installation. This product generates, uses, and can radiate radio frequency energy and, if not installed and used in accordance with the instructions, may cause harmful interference to radio communications. However, there is no guarantee that interference will not occur in a particular installation. If this product does cause harmful interference to radio or television reception, which can be determined by turning the equipment off and on, the user is encouraged to try to correct the interference by one or more of the following measures:

- Reorient or relocate the receiving antenna.
- Increase the separation between the equipment and receiver.
- Connect the equipment into an outlet on a circuit different from that to which the receiver is connected.
- Consult the dealer or an experienced radio/TV technician for help.

FCC Conditions

This device complies with part 15 of the FCC Rules. Operation is subject to the following two conditions:

1. This device may not cause harmful interference.
2. This device must accept any interference received, including interference that may cause undesired operation.

EU CONFORMITY STATEMENT



This product and - if applicable - the supplied accessories too are marked with "CE" and comply therefore with the applicable harmonized European standards listed under the EMC Directive 2014/30/EU, the RoHS Directive 2011/65/EU



2012/19/EU (WEEE directive): Products marked with this symbol cannot be disposed of as unsorted municipal waste in the European Union. For proper recycling, return this product to your local supplier upon the purchase of equivalent new equipment, or dispose of it at designated collection points. For more information see: www.recyclethis.info



Regulation (EU) 2023/1542 (Battery Regulation): This product contains a battery and it is in conformity with the Regulation (EU) 2023/1542. The battery cannot be disposed of as unsorted municipal waste in the European Union. See the product documentation for specific battery information. The battery is marked with this symbol, which may include lettering to indicate cadmium (Cd), or lead (Pb). For proper recycling, return the battery to your supplier or to a designated collection point. For more information see: www.recyclethis.info.

LIST OF CONTENTS

TITLE	PAGE
Safety Summary	5
1. GENERAL INFORMATION	8
1.1 System Description	8
1.2 Key Features	9
2. OPERATING INSTRUCTIONS	10
2.1. Basic Operations	10
2.2 Main Function	18
2.3 Client Software Introduction	37
3. MAINTENANCE	38
3.1 Maintenance	38
3.2 Troubleshooting	39
4. WARRANTY INFORMATION	40
4.1 Warranty Information and Registration	40
5. SPECIFICATIONS	42
5.1 Specifications	42
5.2 Reticle Parameters	45

SAFETY SUMMARY

- Read and follow all instructions
- Read all warnings
- Only use the attachments/accessories specified by the manufacturer
- All service must be provided by the manufacturer

WARNINGS:

- **This product contains natural rubber latex, which may have the potential to cause allergic reactions. If you are allergic to latex, it is important that you strictly avoid exposure to products that contain it.**
- Always make sure your firearm is unloaded before you place the optic on the firearm. Reconfirm that the chamber is empty if you are forced to stop at anytime before completing the zeroing in process. Safe handling rules should be followed at all times.
- If a scope is mounted too far to the rear, the eyepiece may cause an impact injury to the shooter's eye socket. Shooting at an uphill angle also increases this hazard because it shortens the distance between the eyebrow and the rear of the scope. For this reason, AGM scopes are engineered to provide generous eye relief. Therefore, when mounting your scope, we recommend positioning it as far forward in the mounts as possible to take full advantage of this generous eye relief. With hard-recoiling rifles, serious injury or even death can result from eyepiece impact with the shooter during the recoil process when discharging the firearm. Be certain that your installation provides sufficient eye relief for the recoil generated by your rifle before shooting the firearm.

NOTE:

Give special attention to this warning when shooting uphill and/or from a prone position. These shooting conditions can dramatically reduce eye relief. PLEASE maintain maximum eye relief when shooting heavy recoiling and/or magnum firearms. THE USER ASSUMES ALL RESPONSIBILITY AND LIABILITY FOR HAVING THE AGM RIFLE SCOPE PROPERLY MOUNTED TO A FIREARM AND USING THE AGM RIFLE SCOPE PROPERLY. ALWAYS CHECK THE CONDITION OF YOUR MOUNTING SYSTEM PRIOR TO USING YOUR FIREARM.

SAFETY INSTRUCTIONS:

Transportation

- Keep the device in original or similar packaging while transporting it.
- Keep all wrappers after unpacking them for future use. In case of any failure occurred, you need to return the device to the factory with the original wrapper. Transportation without the original wrapper may result in damage on the device and the company shall not take any responsibilities.
- Do not drop the product or subject it to physical shock. Keep the device away from magnetic interference.

Power Supply

- If a power adapter is provided in the device package, use the provided adapter only. If no power adapter is provided, ensure the power adapter or other power supply complies with Limited Power Source (5 VDC/2 A). Refer to the product label for the power supply output parameters.
- Make sure the plug is properly connected to the power socket.
- DO NOT connect multiple devices to one power adapter, to avoid overheating or fire hazards caused by overload.

Battery

- The device supports removable NE-4400 rechargeable Li-Ion battery. The charging limited voltage of the battery is 4.2V. The battery voltage and capacity is 3.6V/4.4Ah (15.84 Wh).
- The purchased batteries by users need to comply with the relevant international standards about battery safety (e.g. EN/IEC standards).
- Improper use or replacement of the battery may result in explosion hazard. Replace with the same or equivalent type only.
- Batteries of improper size cannot be installed, and may cause abnormal shutdown.
- Dispose of used batteries in conformance with the instructions provided by the battery manufacturer.
- Make sure the battery temperature is between 0°C to 45°C (32°F to 113°F) when charging.
- For long-term storage of the battery, make sure it is fully charged every half year to ensure the battery quality. Otherwise, damage may occur.
- Do not charge other battery types with the supplied charger. Confirm there is no flammable material within 2 m of the charger during charging.
- Do not dispose of the battery into fire or a hot oven, or mechanically crush or cut the battery, which may result in an explosion.
- Do not leave the battery in an extremely high temperature or low air pressure environment, which may result in an explosion or the leakage of flammable liquid or gas.
- DO NOT place the device with battery or the battery alone near heating or fire source. Avoid direct sunlight.
- If the battery compartment does not close securely, stop using the product and keep it away from children.
- DO NOT disassemble the battery.
- DO NOT place the battery in the reach of children.
- This device is not suitable for use in locations where children are likely to be present.

Maintenance

- If the product does not work properly, please contact your dealer or the nearest service center. We shall not assume any responsibility for problems caused by unauthorized repair or maintenance.
- Make sure that the power has been disconnected before device teardown and repair by professionals.

- Wipe the device gently with a clean cloth and a small quantity of ethanol, if necessary.
- If the equipment is used in a manner not specified by the manufacturer, the protection provided by the device may be impaired.
- Clean the lens with soft and dry cloth or wiping paper to avoid scratching it.

Using Environment

- Make sure the running environment meets the requirement of the device. The operating temperature shall be -30°C to 55°C (-22°F to 131°F), and the operating humidity shall be from 5% to 95%.
- DO NOT expose the device to high electromagnetic radiation or dusty environments.
- DO NOT aim the lens at the sun or any other bright light.
- Place the device in a dry and well-ventilated environment.
- Avoid equipment installation on vibratory surface.
- When any laser equipment is in use, make sure that the device lens is not exposed to the laser beam, or it may burn out.
- This equipment is not suitable for use in locations where children are likely to be present.

NOTES:

- The detector spectral band provides better visibility through smoke, dust, rain, smog, etc.
- Infrared radiation does not travel through glass. As a result, the rifle scope does not detect objects if they are behind glass windows or other barriers.

LASER CAUTION:

When any laser equipment is in use, make sure that the device lens is not exposed to the laser beam, or it may burn out. The laser radiation emitted from the device can cause eye injuries, burning of skin or inflammable substances. Before enabling the light supplement function, make sure no human or inflammable substances are in front of the laser lens. Do not place the device where minors can fetch it. According to IEC 60825 1:2014, EN 60825 1:2014+A11:2021, and EN 50689:2021, this laser product is classified as Class 1 laser product and consumer laser product.

Complies with FDA performance standards for laser products except for conformance with IEC 60825-1 Ed. 3., as described in Laser Notice No.56, dated May 8, 2019.



1 GENERAL INFORMATION

1.1 SYSTEM DESCRIPTION

The RattlerV3 family is the latest addition to the most popular line of AGM thermal imaging scopes. The RattlerV3 LRF pairs an industry-leading sub-15mK thermal sensors with a new high resolution display, which combines to produce the best thermal image. The RattlerV3 LRF also brings the once inconceivable new in-lens LRF technology to the compact Rattler series. A fully integrated 1,000m laser rangefinder is paired with a new on-board ballistic calculator. A newly designed optics gives the RattlerV3 LRF a base magnification of 2.5X or 3.5X, making it an optimal option for predator hunters in wide-open terrain and entices longer range engagements. Its also the first Rattler ever to come with a shutterless NUC and AGM's powerful Image Boost 4.0 imaging algorithm with automatic scene differentiation and style adaptation. Large sturdy buttons were designed to aid gloved fingers in cold winter weather, while the removable rechargeable NE-4400 battery offers one of the most robust and easy to install battery systems on the market. The firmware package allows users an amazing level of customization: on-board pitch scale, 10 brightness and contrast settings, warm & cold viewing modes, multiple color palettes, picture-in-picture, ballistic calculation, on-board video recording with sound, WiFi hotspot, multiple zeroing profiles, shot activated video recording, defective pixel repair, hotspot locator and multiple laser range finding modes.

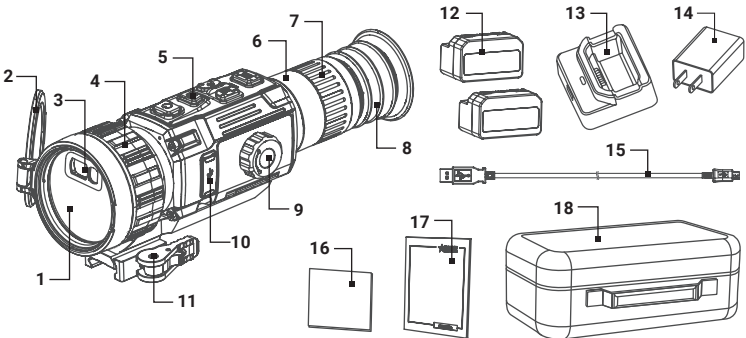

FIGURE 1-1. MAIN PARTS AND COMPONENTS

TABLE 1-1. MAIN PARTS AND COMPONENTS

ITEM	DESCRIPTION	ITEM	DESCRIPTION
1	Lens	10	USB Type-C Interface
2	Lens Cover	11	Mount*
3	Laser Range Finder	12	NE-4400 Li-Ion Battery (2)
4	Lens Focusing Ring	13	NE-4400 Charger
5	Operation Buttons	14	Power Adapter
6	Ocular	15	USB Cable
7	Diopter Adjustment Ring	16	Lens Tissue
8	Eyecup	17	User Manual & QSG
9	Battery Compartment	18	Carrying Case

* The mounting system depends on the region of sale.

1.2 KEY FEATURES

- 12 micron detector with 640x512 or 384x288 resolution
- Sub-15mK thermal sensitivity
- Image Boost 4.0: new improved self-adaptive Image processing algorithm with reduced noise and enhanced target highlighting
- Automatic scene differentiation and style adaptation. Optimization of scenes with high energy and low temperature difference
- Shutterless technology
- Built-in 1,000m laser rangefinder
- Ballistic calculator
- Various reticle types and colors
- 1x, 2x, 4x, 8x digital zoom
- Large OLED display
- On-board video/audio recording and image capture
- UVC screen casting via USB Type-C interface
- Shot Activated Recording (SAR) function
- Built-in EMMC storage (64 GB)
- WiFi data transmission
- Standby mode
- More than 7 hours of battery life (depends on the model)
- External power supply compatibility
- Waterproof & shockproof

2 OPERATING INSTRUCTIONS

2.1. BASIC OPERATIONS

2.1.1 PREPARATION FOR USE

The following steps must be completed prior to each use.

1. Open the carrying case, remove the device, and verify that all components are included.
2. Inspect the device for any signs of damage to the optical surfaces, body, eyecup, operation buttons, etc. Ensure that all optical surfaces are clean and ready for use.

2.1.2 BATTERY INSTRUCTION

1. The device supports a removable NE-4400 Li-Ion rechargeable battery. The battery voltage is 3.6V and the capacity is 4.4Ah (15.84 Wh). The battery charging voltage is limited to 4.2V.
2. Before first use, charge the battery to full capacity using the NE-Charger. You can also charge the battery installed in the device using an external 5V/2A power adapter via the scope's USB port.
3. Be sure to remove the battery when storing the device for long periods of time.

2.1.3 BATTERY INSTALLATION

To install the battery (refer to Figure 2-1):

1. Turn the battery cover knob (A) counter clockwise and then open the battery cover (B).
2. Push the red latch (C) aside (as the arrow shows), and release the battery.
3. Insert the battery (D) into the battery compartment. The latch locks the battery in place when the battery is fully inserted.
4. Once the battery is locked into place, close the battery door until a "click" is heard, or felt. This means the internal battery door lever is engaged with the housing to secure the battery door in place.

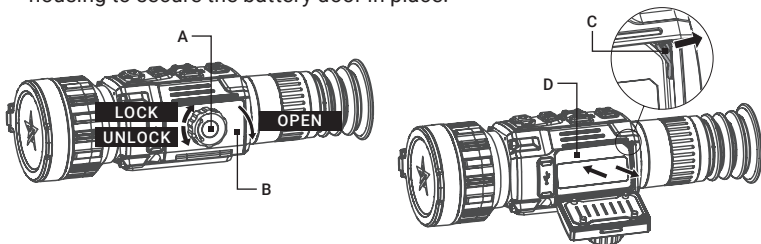

FIGURE 2-1. BATTERY INSTALLATION

CAUTION:

Verify that the device is turned off before removing the battery.

2.1.4 CONTROL BUTTONS

The RattlerV3 controls are shown in Figure 2-2 and are defined in Table 2-1. Each button is responsible for some functions selected by short press or long press of the button. Pushing a button for 3+ second is considered “long press/hold.”

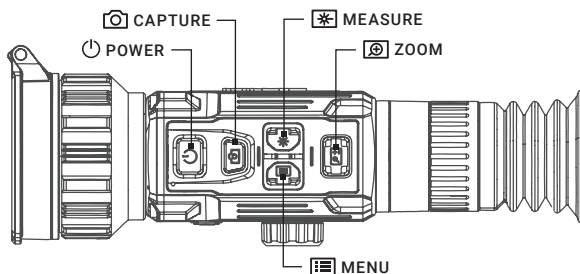









FIGURE 2-2. CONTROL BUTTONS

TABLE 2-1. BUTTON FUNCTIONS

BUTTON	FUNCTIONS
 POWER	Press: Standby Mode/Wake Up Device Long Press: Power On/Off
 MENU	Press: Palette Switching Hold: Enter the Main Menu MENU MODE Press: Confirm/Set Parameters Long Press: Exit the Menu
 LRF	Press: Turning on the Laser / Distance Measurement Double Press: Turning Off the Laser Long Press: Image Calibration (FFC)
 CAPTURE	Press: Image Capture Long Press: Start/Stop Video Recording MENU MODE Press: Up/Change Parameters
 ZOOM	Press: Switching Digital Zoom Long Press: Enable/Disable PIP Mode MENU MODE Press: Down/Change Parameters

Press the LRF button  and CAPTURE button  at the same time to quickly activate ballistic calculation in the live view mode (effective when the Reticle is enabled).

2.1.5 POWER ON AND OFF

Power On

With the battery installed, press and hold the POWER button to turn on the device. The LED power indicator in the POWER button will light up.

Power Off



When the device is turned on, hold the POWER button  to turn off the device.

Auto Power Off

In the "Auto Power Off" submenu of General Settings you can set the time for the automatic shutdown of the device as required (see 2.2.34 for details).

2.1.6 STANDBY MODE

Standby mode is used to save battery power. In this mode, some power-consuming features such as the display, network hardware, or internal storage will be temporarily disabled.

In the view mode, press the POWER button . After a few seconds, the display will turn off. Press the POWER button  again to exit the Standby mode.

2.1.7 VIEWING THE THERMAL IMAGE

1. Power on the rifle scope.
2. Open the lens cover, bring the scope to your eye and make sure the eyecup covers your eye. The internal display will show the thermal image and on-screen interface.
3. Use the diopter adjustment ring (rotating ring closest to your eye) to ensure that the on-screen interface elements are crisp and sharp. Once completed, this adjustment will not be needed again until a new user is using the device.
4. Once the diopters are set, all image focusing for various distances will occur using the front lens focusing ring.

NOTE:

You must perform the focus adjustment before any further use of the scope.

5. Set palette, brightness, contrast, tone, and scene mode to display the best image effect.

2.1.8 ON-SCREEN DISPLAY

On-screen interface displays the menu items and device status indicators.

Long press the MENU button  in the view mode to display or hide the menu.

Adjust the On-Screen Display (OSD) in the Function Settings menu (see 2.2.23).

When OSD is on, the information of Shot Activated Recording (SAR) function, WiFi hotspot activation, storage memory status, battery status, current magnification setting, time and date displays on the screen.

The screen can also display the reticle, recommended aiming point, LRF mark, current zeroing profile, zeroing distance, distance measurement result, drop distance and the pitch scales. You can configure the display of all these elements in the scope's menu.

NOTE:

The RattlerV3 LRF 35-384 model has the ability to switch between the Circular and Rectangular display interface shape. Use the menu to configure.

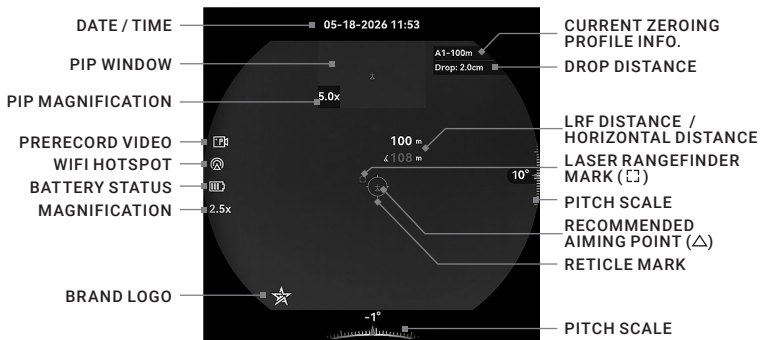

FIGURE 2-3. ON-SCREEN DISPLAY

2.1.9 PALETTE SETTINGS

You can select different palettes to display the same scene in different effects. In the live view mode, press the MENU button to select a mode (image palette).

TABLE 2-2. PALETTE SETTINGS

PALETTE	DESCRIPTION
WHITE HOT	The hot part is displayed in white. The higher the temperature, the lighter the color.
BLACK HOT	The hot part is displayed in black. The higher the temperature, the darker the color.
FUSION	The hot part is displayed in white. From high temperature to low temperature, the image is colored in from white, yellow, red, pink to purple.
RED HOT	The hottest part is displayed in red, the rest of the image will be flushed out in shades of gray.
RED MONOCHROME	The image is colored in shades of red. The higher the temperature, the lighter the color.
GREEN MONOCHROME	The image is colored in shades of green. The higher the temperature, the lighter the color.

2.1.10 DIGITAL ZOOM

Press the ZOOM button in the view mode to switch between 1x, 2x, 4x and 8x digital zoom. The image magnification value is displayed on the screen: 2.5x / 5x / 10x / 20x (35-640 model) or 3.5x / 7x / 14x / 28x (35-384 and 50-640 models).

NOTE:

In the AGM Connect app you can set any magnification in 0.1x increments.

When the Picture-in-Picture (PIP) function is activated, the image will be enlarged by the zoom factor only in the PIP window. In this case, the current PIP magnification is displayed in the corner of the PIP window for a few seconds after the change.

2.1.11 DISTANCE MEASUREMENT

The device can detect the distance between the target and the observation position with built-in laser rangefinder.



Make the laser rangefinder settings in the menu (see details in part 2.2.16). Point the rangefinder mark (the LRF mark style and color can be customized in the menu) at the target and press the LRF button  to measure the distance to the target.

The distance measurement result is displayed in the screen center and will disappear after 10 seconds. If the distance measurement fails or cannot reach a valid value, "000" will be displayed. The device also supports the **Horizontal Distance** measurement function.

You can scan the surroundings under **Continuous** mode. Continuous distance scanning will occur for a set time of 5, 10, 15, 30, or 60 seconds after pressing the LRF button .

Press the LRF button twice to turning off the laser.

2.1.12 BALLISTIC CALCULATION

The ballistic calculation helps you have a better experience in various conditions. Multiple parameters are required in calculation to ensure precision and flexibility of use. Ballistic Calculation can be activated via the device menu (see section 2.2.9 for details) or by simultaneously pressing the LRF button  and CAPTURE button  in the live view mode (only when the reticle is enabled).

If you are using the ballistic calculator, the recommended aiming point will be displayed on the screen and the drop distance will be indicated in the upper right corner of the interface. You can adjust the style and color of the aim point in the device menu.

NOTE:

- Continuous Laser Ranging mode cannot be set if Ballistic Calculation is enabled.
- If the Continuous Laser Ranging mode is in use, it will be switched to Once mode after enabling Ballistic Calculation. When Ballistic Calculation is turned off, the laser ranging mode will be reverted to Continuous.

2.1.13 PICTURE IN PICTURE

The Picture-in-Picture (PIP) mode allows you to see simultaneously both a magnified image of the central part in a PIP window and the main image. The PIP window is displayed at the up-center of the live view. In the live view you can enable or disable the PIP function by holding the ZOOM button .

The PIP window displays the details of central part of the image at 2x zoom.

NOTE:

- When the reticle is enabled, the PIP view displays a magnified area around the centre of the crosshair or recommended aiming point. When the reticle is not enabled, the PIP view displays a magnified central area of the image.
- If PIP mode is activated, when using digital zoom, the image will be zoomed in only in the PIP window.
- To prevent the large reticle in the PIP view from obscuring the target and the aim point, only the reticle centre is retained in the PIP window (reticle types 5, 6, and 10 will not be changed).

2.1.14 IMAGE CALIBRATION

RattlerV3 uses shutterless technology. It is based on continuous study of different grey backgrounds, and it is a dynamic correction process that does not lead to loss of image quality. This eliminates the need for periodic calibration pauses, ensuring you never miss a critical moment in the field.

You also can use **Manual** or **Semi-Auto** option to correct the non-uniformity of display when necessary. Hold the LRF button  in the view mode to correct the non-uniformity of display. See part 2.2.27 for more details on the Flat Field Correction function.

2.1.15 VIDEO RECORDING AND IMAGE CAPTURE

Video Recording

Hold the CAPTURE button  in the view mode and start recording. The recording time is displayed at the top of the screen.

Hold the CAPTURE button  again to stop recording.

Image Capture

Press the CAPTURE button  in the view mode, to capture the image.

NOTE:

When captured, the image freezes for 1 second and a prompt shows on the display.

2.1.16 CONNECTING THE DEVICE

1. Open the USB interface cover.
2. Connect the device and power adapter with a USB Type-C cable to charge the battery installed in the device. You can also power the device using an external power source via the USB port. Alternatively, you may also connect the device to your computer using the included USB cable to copy/delete files.

The LED indicator near the USB port indicates the following statuses:

Solid Red: the device is charging.

Solid Green: the device is fully charged.

Flashing Red & Green: the battery is not installed and the device is powered by an external power supply / an error has occurred.

Off: device is not charged.

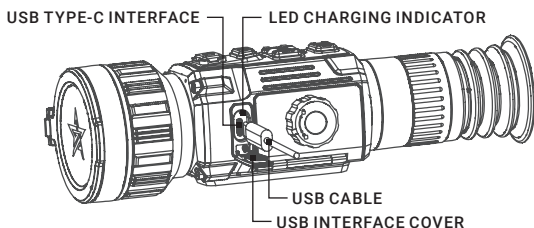

FIGURE 2-4. CONNECTING THE DEVICE

2.1.17 FILE EXPORT

1. Before connecting the thermal rifle scope to a computer, please make sure that the WiFi function of the rifle scope is disabled.
2. Connect the thermal rifle scope to your PC with USB cable and open the detected disk.
3. The directory is named by the current date. Enter **AGM Content > "Date"** to view the videos and snapshots.
 - Select and copy the videos to PC and play the file with the player.
 - Select and copy the snapshots to PC and view the files.
4. Disconnect the device from your PC.

NOTE:

- The device displays images when you connect it to PC. But functions such as recording, capturing and hot spot are disabled.
- When you connect the device to PC for the first time, it installs the driver automatically.

You can also manage image and video content via the AGM Connect mobile app (see Section 2.3).

2.1.18 INSTALLATION ON PICATINNY/WEAVER RAIL

WARNING:

Always make sure your firearm is unloaded before you place the scope on the firearm. Reconfirm that the chamber is empty if you stop the procedure then resume later. Safe firearms handling rules should be followed at all times.

The RattlerV3 comes with a Picatinny/Weaver mount. The mount is secured to the scope with two screws. The recommended tightening torque for the fixing screws is 4-5.3 Nm (35.4-46.9 in-lbs).

NOTE:

Mount model depends on the region of sale. Different models of mounts may have different designs.

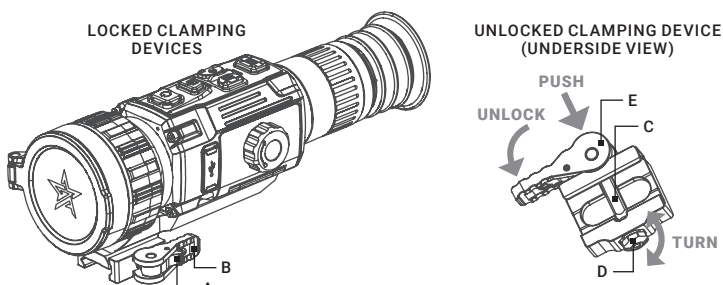

FIGURE 2-5. MOUNT

To install the RattlerV3 on a Picatinny/Weaver rail, perform the following:

1. Unlock the clamping device of the scope mount by pushing down on the lever holder (A) and unlocking the lever (B).

2. Install the scope on the Picatinny/ Weaver rail so that the stop (C) slides into the transverse slot on the rail.
3. Affix the scope to the rail by locking the lever (B).
4. Verify that the clamping device is firmly holding the RattlerV3. If necessary, adjust the clamping device's lever-cam lock as detailed in part 2.1.19.

2.1.19 CLAMPING DEVICE ADJUSTMENT

To adjust the mount's clamping device, do the following:

1. Remove the RattlerV3 from the rail.
2. With the clamping device unlocked (as shown in Figure 2-5), push the cam (E) towards the arrow, which will cause the nut (D) to slide out of its hole.
3. To tighten/ loosen the clamping device, push down on the cam (E) and turn the nut (D) CW/CCW respectively, in one-two increments (see note below). Much like when the cam (E) is released, backward-moving spring will cause the nut (D) to slide back into its hole.

NOTE:

The eight-sided nut of the mount lever-cam lock will only fit into their hole if turned in one of the discrete positions, using increments equal to $360^{\circ}/8$.

4. Verify that the adjusted lever-cam lock securely holds the mounting rail.

2.2 MAIN FUNCTIONS

2.2.1 MAIN MENU

In the live view mode, hold the MENU button  to display the Main Menu. In the Main Menu, you can set parameters such as Brightness, Contrast, Sharpness, Zoom Pro, and also select the Advanced Menu for additional settings.

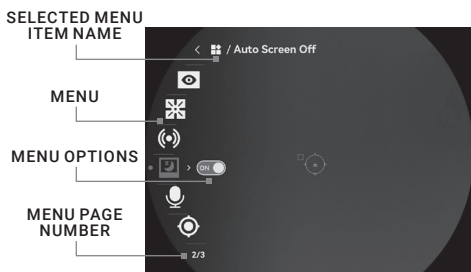































FIGURE 2-6. MAIN MENU



















Press  or  buttons to move between menu items. The active element is highlighted. Press the MENU button  to select menu item or change an option.

Hold the MENU button  to exit the menu.

TABLE 2-3. MENU FUNCTIONS

MENU ITEM	SYMBOL	OPTION	FUNCTION
BRIGHTNESS		10 Levels of Brightness	Adjusts the image brightness.
CONTRAST		10 Levels of Contrast	Adjusts the image contrast.
SHARPNESS		5 Levels of Sharpness	Adjusts the image sharpness.
ZOOM PRO		OFF / ON	Enables or disables the Zoom Pro function.
ADVANCED SETTINGS		Advanced Settings Menu:	
ZEROING PROFILES		5 Profiles (A/B/C/D/E)	Zeroing profile selection with user saved zeroing settings.
ZEROING		Zeroing Menu:	
Zeroing		OFF / 1 / 2 / 3 / 4 / 5	Zeroing settings selection or disable reticle.
Bullet		Bullet Name	Setting the bullet name (9 characters).

MENU ITEM	SYMBOL	OPTION	FUNCTION
Type		10 Reticle Type	Setting the reticle type.
Reticle Color		4 Reticle Colors	Setting the reticle color (black, white, red, green).
Reticle Center Color		4 Reticle Center Colors	Setting the reticle center color (black, white, red, green).
Reticle Brightness		5 Levels of Reticle Brightness	Adjusts the reticle brightness.
Correction		Correction Menu:	
Distance		Distance to the target	Setting the distance to the target.
Zoom		2.5x / 5x / 10x / 20x (35-640 model) 3.5x / 7x / 14x / 28x (35-384 and 50-640 models)	Setting the magnification with Digital Zoom.
Freeze Screen		OFF / ON	Image freeze.
X/Y Axis		X / Y	Setting up correction along the X and Y axes.
Ballistic Calculation		Ballistic Calculation Menu:	
Ballistic Calculation		OFF / ON	Enables or disables the ballistic calculation.
Aim Point Style		4 Aim Point Styles	Setting the aim point style (•, x, ><, Δ).
Aim Point Color		4 Aim Point Colors	Setting the aim point color (black, white, red, green).
Parameters		Drag Model / Initial Velocity / Altitude / Temperature / Ballistic Coefficient / Sight Height	Input the data to display the recommended aiming point and the drop distance.
ALBUMS		---	View/Delete local files.
RETICLE MODE		Fixed Reticle / Central Reticle	You can select a reticle mode according to your preference and different situations
PRERECORD		OFF / 5s / 10s / 15s	Setting the recording time before and after the recoil activation.







MENU ITEM	SYMBOL	OPTION	FUNCTION
tone		Cold / Warm	Switch between the Cold mode and Warm mode.
SCENE MODE		General / Compressed / Auto	Switch between the General, Compressed and Auto mode.
LASER RANGING		Laser Ranging Menu:	
Ranging Mode		Once / Continuous (5s, 10s, 15s, 30s, 60s)	LRF distance measurement settings.
Horizontal Distance		OFF / ON	Enables or disables the display of horizontal distance.
Rangefinding Reticle Style		3 Rangefinding Reticle Style	Setting the rangefinding reticle style (□, ◊, •).
Rangefinding Reticle Color		4 Rangefinding Reticle Color	Setting the rangefinding reticle color (black, white, red, green).
NETWORK		Close / Hotspot	Enables or disables the WiFi hotspot.
DISPLAY INTERFACE SHAPE (35-384 only)		Circular / Rectangular	Switch between the circular and rectangular display interface shape.
AUTO SCREEN OFF		OFF / ON	Function darkens the screen to save energy.
AUDIO		OFF / ON	Enable or disable audio recording.
HOT TRACKING		OFF / ON	Enables or disables hot spot mark (marking the spot of highest temperature).
CHANNEL VIEWING ACTIVATION		OFF / ON 6 palettes	Setting up the display of different palettes for selection.
FUNCTION SETTINGS		Function Settings Menu:	
OSD		OSD / Time / Date	Enables or disables OSD, time, date.
Pitch Scale		OFF / ON	Enables or disables Pitch Scale to view the device inclination angle in the live view.
Brand Logo		OFF / ON	Enables or disables AGM logo on the screen.
USB Connection		USB Flash Drive/ Digital	USB port mode settings.

MENU ITEM	SYMBOL	OPTION	FUNCTION
Image Calib.		Semi-Auto / Manual	Selecting the Flat Field Correction (FFC) mode.
DPC		Axis: X/Y	Correction of dead pixel manually.
Burn Prevention		OFF / ON	Enables or disables the Burn Prevention function.
GENERAL SETTINGS		General Settings Menu:	
Language		26 Languages	Choice of interface language.
Time		12 / 24 hour	Time setting.
Date		Month/Day/Year	Date setting.
Unit		yd / m	Sets the distance unit.
Auto Power Off		OFF / 15 min / 30 min / 45 min	Setting the automatic shutdown time.
Remote Access		OFF / ON	Provides network access to the device (e.g., the AGM Connect App)
Reboot		---	Reset the basic settings: Brightness, Contrast, PIP, etc.
Restore Factory Settings		---	Restoring the default device settings, erase zeroing settings and all internal storage content.
Diagnostic Log		OFF / ON	Using for recording device status and troubleshooting.
Passcode		OFF / ON	You can set a passcode to lock the device screen and prevent unauthorized access.
Change Passcode		4-Digit Numeric Passcode	You can set/change the passcode.
Version		---	Firmware version, serial number, Security version, Redline info and free space of built-in storage.

2.2.2 BRIGHTNESS ADJUSTMENT







1. Hold the MENU button in live view mode to call the Main Menu.
2. Press and buttons to select the **Brightness** menu item and press the MENU button to confirm.
3. Press and buttons to adjust the brightness. You can select one of ten levels of the brightness to adjust the image lighter or darker.
4. Press the MENU button to exit brightness adjustment.

2.2.3 CONTRAST ADJUSTMENT

1. Hold the MENU button  in live view mode to call the Main Menu, then select the  Contrast menu item and press the MENU button  to confirm.
2. Press  and  buttons to adjust the image contrast. You can select one of ten levels of the contrast.
3. Press the MENU button  to exit contrast adjustment.





2.2.4 SHARPNESS SETTING

This function allows you to adjust the sharpness of the thermal image.

1. Hold the MENU button  in live view mode to call the Main Menu, then select the  Sharpness menu item and press the MENU button  to confirm.
2. Press  or  button to adjust the image sharpness. You can select one of five levels of the sharpness.
3. Press the MENU button  to exit sharpness adjustment.

2.2.5 ZOOM PRO



When you turn on Zoom Pro function, the details of zoomed image will be enhanced.

1. Hold the MENU button  in live view mode to call the Main Menu, then select the  Zoom Pro menu item and press the MENU button  to enable or disable Zoom Pro mode.
2. Rotate the wheel to select other item or hold the MENU button  to exit a menu.
4. Hold the MENU button  to exit.

NOTE:









- If the PIP function is enabled, Zoom Pro is only enabled in the PIP view.
- Zoom Pro cannot be enabled when device battery is low.

2.2.6 ADVANCED SETTINGS MENU

Hold the MENU button  in the live view mode to call the Main Menu. Select the  Advanced Settings menu and press the MENU button  to confirm. The Advanced Settings menu contains all the necessary parameters to fully configure the device.

2.2.7 ZEROING PROFILES

The user can customize and save five profiles with different reticle settings. In each profile, you can configure up to five types of reticle, firing distances and reticle corrections.

1. Enter the  Advanced Settings menu.
2. Press  or  button to select  Zeroing Profiles menu item and press the MENU button  to confirm.
3. Press  or  button to switch the zeroing profile.
4. Press the MENU button  to exit Zeroing Profile setting.

The right top of the image displays the reticle information. For example, A1-100m means you are using the Zeroing No. 1 in the Profile A, and the set range is 100 m.



















NOTE:

There are 5 zeroing profiles in total, and you can configure 5 reticles, zeroing distances and corrections in each zeroing profile.

2.2.8 ZEROING







You can select a reticle in the current zeroing profile, and set parameters such as reticle type, color, and boresight correction (coordinates) for the reticle.

Select a zeroing profile initially (refer to 2.2.7).

1. Enter the  **Advanced Settings** menu.
2. Press  or  button to select  **Zeroing** menu item and press the MENU button  to enter the zeroing setting interface.
3. Set zeroing number (from 1 to 5).
 - 1) Press  or  to select  **Zeroing** and press the MENU button  to confirm.
 - 2) Press  or  button to select **OFF** (reticle is disabled) or zeroing number you want to correct and press the MENU button  to confirm.
4. Set reticle type (for parameters of all built-in reticles, see part 5.2).
 - 1) In the zeroing setting interface press  or  button to select  **Type** submenu and press the MENU button  to confirm.
 - 2) Press  or  button to select a reticle type and press the MENU button  to confirm.















NOTE:

The scale intervals of the Reticle 4 and Reticle 7 change synchronously under the current digital zoom.

5. Set reticle color.
 - 1) In the zeroing setting interface press  or  button to select  **Reticle Color** submenu and press the MENU button  to confirm.
 - 2) Press  or  button to select black, white, red or green color of reticle and press the MENU button  to confirm.

NOTE:

In Black Hot mode and White Hot mode, if you set the reticle color as white or black, the reticle colors can be automatically inverted depends on thermal image around the reticle.

6. Set reticle center color.
 - 1) In the zeroing setting interface press  or  button to select  **Reticle Center Color** submenu and press the MENU button  to confirm.
 - 2) Press  or  button to select black, white, red or green color of reticle center and press the MENU button  to confirm.
7. Set reticle brightness.
 - 1) In the zeroing setting interface press  or  button to select  **Reticle Brightness** submenu and press the MENU button  to confirm.
 - 2) Press  or  button to select one of five levels of the reticle brightness to adjust the reticle mark lighter or darker. Press the MENU button  to confirm.
8. (Optional) Repeat 3 to 7 to set type and color for other reticles in this profile.
9. Hold the MENU button  to save and exit.

2.2.9 BORESIGHT CORRECTION

Like any daytime rifle scope or red dot, sighting in is both similar, and simplified. The RattlerV3 comes with a one-shot zeroing system, which makes initial sighting in quick and painless.

Set the target to the selected zeroing distance. We recommend 50-100 yards initially. Select a zeroing profile (refer to 2.2.7). You can use different zeroing profiles if you want to use the optic on a different rifles.



FIGURE 2-7. BORESIGHTING

Align the reticle with the center of the target and shoot. If the point of impact does not coincide with the aiming point, correct the reticle.

1. Enter the **Advanced Settings** menu.
2. Press **[Camera]** or **[P+]** button to select **Zeroing** menu item and press the MENU button **[Menu]** to enter the zeroing setting interface.
3. Press **[Camera]** or **[P+]** button to select **Zeroing** and press the MENU button **[Menu]** to confirm. Press **[Camera]** or **[P+]** button to select zeroing number you want to correct and press the MENU button **[Menu]** to confirm.
4. Press **[Camera]** or **[P+]** button to select **Bullet** and press the MENU button **[Menu]** to set the bullet name for your reticle profiles. Press the MENU button **[Menu]** to select the character to edit, and press **[Camera]** or **[P+]** button to change the character. After you finish to entering the bullet name, hold the MENU button **[Menu]** to exit.
5. Press **[Camera]** or **[P+]** button to select **Correction** and press the MENU button **[Menu]** to enter the correction interface.

Set the distance to the target:

- 1) In the correction interface press **[Camera]** or **[P+]** button to select **Distance** and press the MENU button **[Menu]** to confirm.
- 2) Press the MENU button **[Menu]** to select the digit you want to change (color of selected digit will changed to the red).
- 3) Press **[Camera]** or **[P+]** button to change the number and press the MENU button **[Menu]** to confirm.





(Optional) Set the magnification:

- 1) In the boresight correction interface press **[Camera]** or **[P+]** button to select **Zoom** option and press the MENU button **[Menu]** to confirm.
- 2) Press **[Camera]** or **[P+]** button to enlarge the image until the target positions is clear enough. Press the MENU button **[Menu]** to confirm.

NOTE:

We'd suggest zeroing in at 1x, or your true optical base magnification, or 2x zoom (double your optical magnification) as these options are less pixelated and should provide for easier adjustments.





(Optional) Activate Freeze Screen function:

- 1) In the boresight correction interface press  or  button to select  Freeze Screen option.
- 2) Press the MENU button  to enable the Freeze Screen function.



NOTE:

When enabling the Freeze Screen function, you can adjust the position of the cursor on a frozen image. This feature helps prevent image flutter and eliminates the need to hold the rifle scope steady in order to make your windage and elevation adjustments on screen.

Set the boresight correction:

- 1) In the boresight correction interface press  or  button to select  X/Y Axis and press the MENU button  to confirm.

Two marks are displayed on the screen. The first mark is the reticle selected in the Zeroing menu. The second, small crosshair is the reference mark. The reference mark is located in the center of the screen. Initially, the centers of both marks are aligned. Zero the scope by moving the reticle on the screen.

- 2) Aim the reticle at the center of target.
- 3) Press the MENU button  to select X or Y axis.
- 4) Press  or  button to move reticle left and right (if X axis is selected) or to move reticle up and down (if Y axis is selected).

Holding the reference small crosshair at the aiming point (center of the target) and move the reticle until it is aligned with the point of impact. The coordinates show the current position of the reticle. It also displays the distance by which the point of impact will move, taking into account the set distance to the target.

6. Hold the MENU button  return to the previous menu.

TABLE 2-4. BORESIGHT CORRECTION

MODEL	ADJUSTMENT VALUE	RETICLE OFFSET	BORESIGHT INCREMENT
RattlerV3 LRF 35-384	1 click	1 pixel	0.07 mil / 0.25 MOA / 0.7 cm at 100 m distance / 0.3 in at 100 yd distance
RattlerV3 LRF 35-640	1 click	1 pixel	0.17 mil / 0.59 MOA / 1.7 cm at 100 m distance / 0.6 in at 100 yd distance
RattlerV3 LRF 50-640	1 click	1 pixel	0.12 mil / 0.41 MOA / 1.2 cm at 100 m distance / 0.4 in at 100 yd distance

7. (Optional) Repeat 3 to 5 to set the position for other reticles in this profile. You can place up to five zeroes at different distances within the same profile (useful for certain calibers with highly fluctuating trajectories between 50 and 250 yards/meters).

8. Hold the MENU button  to exit Zeroing menu. The window "Save the parameters?" will appear.
 - OK: Save the settings and exit.
 - CANCEL: Exit without saving the settings.

You can also quickly zero your scope using the **AGM Connect** app.

Install the application on your phone and connect your thermal device via WiFi hotspot as described in Chapter 2.3.



1. Run the application.
2. Select your device in the application menu.
2. Select **Zero** in the **Device Info** section.
3. The zeroing interface will appear on the screen of your smartphone. Following the instructions on the screen, make the settings similar to those described above in Paragraph 2.2.9.

2.2.10 BALLISTIC CALCULATION

The ballistic calculation helps you have a better experience in various conditions. Multiple parameters are required in calculation to ensure precision and flexibility of use. The ballistic calculation supports pitch angle compensation. The device can automatically adjust the position of the recommended aiming point mark by reading the pitch angle data from the gyroscope and entering it into the algorithm.

NOTE:

- Make sure the reticle is enabled and you have finished zeroing.
- Continuous laser ranging is not available when enabling ballistic calculation.

1. Enter the  **Advanced Settings** menu. Select  **Zeroing** /  **Zeroing** and set the zeroing number you want to correct.
2. Press  or  button to select  **Ballistic Calculation**. Press the MENU button  to enter the setting interface.
3. Select  **Ballistic Calculation** and press the MENU button  to enable/disable this function.
4. Select  **Aim Point Style** and press the MENU button  to confirm. Press  or  button to set the style of the aim point (•, ×, ><, Δ). Press the MENU button  to exit **Aim Point Style** setting.
5. Select  **Aim Point Color** and press the MENU button  to confirm. Press  or  button to set the color of the aim point (black, white, red, green). Press the MENU button  to exit **Aim Point Color** setting.
6. Select  **Parameters** and press the MENU button  to enter the parameter configuration interface. Press  or  button to select the following parameters, and press the MENU button to input the data.

Drag Model: Set the bullet-specific drag model, e.g. G1, G7 and GS.

Initial Velocity: Input the muzzle velocity of your projectile.

NOTE:



Velocity varies depending on different conditions, barrel length, etc. Muzzle velocity can be obtained by using an accurate ballistic chronograph and/or by following ammo manufacturer specifications.

Altitude: Set current local altitude.

Temperature: Set the ambient temperature.

Ballistic Coefficient (B.C.): The measure of its ability to overcome air resistance.

Sight Height: The distance between the bore and the center of the lens.

Press the MENU button  to switch digit, and press  or  button to change the number.

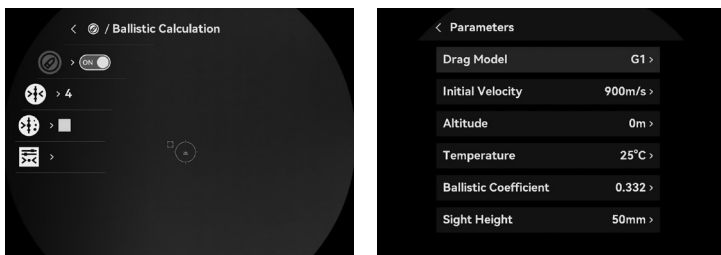



FIGURE 2-8. BALLISTIC CALCULATION

7. Hold the MENU button  to save and exit.
8. Aim the LRF mark at the target and press LRF button  to measure the distance. The screen will display the recommended aiming point (for example, green triangle Δ) and the drop distance in the upper right corner of the live view.
9. (Optional) To adjust distance, repeat the step 8.

NOTE:

- Ballistic calculations is linked to Zeroing Profiles and Zeroing number. 25 ballistic profiles can be saved. You can create a complete set of profiles containing zeroed reticles and ballistic information.
- The more parameters you specify, the more accurate the recommended aiming point will be.
- The drop distance is related to the input parameters. Please refer to the actual situation.







2.2.11 ALBUMS

Captured images and recorded videos are automatically stored in the device, and you can view the files in local albums.



1. Enter the  **Advanced Settings** menu.
2. Press  or  button to select  **Albums** menu item and press the MENU button  to confirm.

NOTE:

The albums are automatically created and named by year + month. The local pictures and videos of a certain month are stored in the corresponding album. For example, the pictures and videos of August in 2025 are saved in the album named "202508".

3. Press  or  button to select the album, and press the MENU button  to enter it.
4. Press  or  button to select a file to view.
5. Press the MENU button  to view the selected file and relevant information.

NOTE:









Files are arranged in chronological order, with the most recent at the top. If you fails to find the most recently taken snapshots or videos, please check the time and date settings of your device. When you are viewing files, you can switch to other files by pressing  or  button.

When you are viewing videos, you can press the MENU button  to play or stop the video.

For deleting an album or a file, you can press  button to call the dialogue box, and delete the album or file according to the prompt.

2.2.12 RETICLE MODE

You can select a reticle mode according to your preference and different situations.

1. Enter the  **Advanced Settings** menu.
2. Press  or  button to select  **Reticle Mode** and press the MENU button  to open the options.
3. Press  or  button to select **Fixed Reticle** or **Central Reticle** and press the MENU button  to confirm.

Fixed Reticle: This mode centers around the reticle when switching the digital zoom ratio, with the reticle position unchanged.

Central Reticle: This mode centers around the reticle when switching the digital zoom ratio, with the reticle and zoomed image moved to the center of the display.









3. Hold the MENU button  to confirm the selection and exit.

NOTE:

- The actual zoom ratio returns to the minimum value when switching the reticle mode.
- The zoom ratio may vary according to different models. Please take the actual product for reference.









2.2.13 PRERECORD VIDEO

After enabling the Shot Activated Recording (SAR) function, the device will automatically start recording 5, 10, or 15 seconds before and after the recoil-activation.

1. Enter the  **Advanced Settings** menu.
2. Press  or  to select  **Prerecord** and press the MENU button  to open the options.
3. Press  or  button to select OFF (disabled SAR) or 5s, 10s, 15s recording time and press the MENU button  to confirm the selection and exit.







2.2.14 IMAGE TONE SETTING

This function allows you to change the tone of thermal image to warm or cold.

1. Enter the  **Advanced Settings** menu.
2. Press  or  button to select  **Tone** menu item and press the MENU button  to confirm.
3. Press  or  button to select **Warm** or **Cold** tone.
4. Press the MENU button  to exit.

2.2.15 SCENE MODE

You can select proper Scene Mode according to environment temperature to improve the display effect.

1. Enter the  **Advanced Settings** menu.
2. Press  or  button to select  **Scene Mode** menu item and press the MENU button  to confirm.
3. Press  or  button to switch scene mode:

General mode: Improves an image so that the object edge is more distinct.

































Compressed mode: Is more suitable for hunting environment because of the highlight function of small objects.

Auto mode: The algorithm automatically distinguishes between lighting scenes and adapts the display style accordingly. In high-energy scenes (e.g., sunny days or scenes with many detailed objects), will by applying sharpening adjustment to reduce the edge effect. In scenes with low temperature differences (e.g., pure grassland or forest scenes), detail enhancement will be applied to improve clarity and visibility.

4. Press the MENU button  to confirm and exit.

2.2.16 SET LASER RANGING

The device can detect the distance between the target and the observation position with built-in laser rangefinder.

1. Enter the  **Advanced Settings** menu.
2. Press  or  button to select  **Laser Ranging** menu item and press the MENU button  to confirm.
3. Press  or  button to select  **Ranging Mode** submenu and press the MENU button  to open the options.
4. Press  or  button to select the laser ranging mode between **Once** and **Continuous (5s)**, **Continuous (10s)**, **Continuous (15s)**, **Continuous (30s)**, **Continuous (60s)**. Press the MENU button  to set selected mode. Press the MENU button  to confirm.
5. Press  or  button to select  **Horizontal Distance** option, and press the MENU button  to display the horizontal distance between the target and the observation position on the screen.
6. Press  or  button to select  **Rangefinding Reticle Style** option and press the MENU button  to confirm. Press  or  button to select a rangefinding reticle style from 3 options (□, ○, •) and press the MENU button  to confirm.
7. Press  or  button to select  **Rangefinding Reticle Color** option and press the MENU button  to confirm. Press  or  button to select a rangefinding reticle color from 4 options (black, white, red or green) and press the MENU button  to confirm.
8. Hold the MENU button  to exit.

NOTE:

When ballistic calculations are enabled, only **Once** ranging mode is supported.







When the **Once Mode** is selected, point the square mark of the rangefinder at the target and press the LRF button  to measure the distance to the target.

You can scan the surroundings under **Continuous Mode**. Continuous distance scanning will occur for a set time of 5, 10, 15, 30 or 60 seconds after pressing the LRF button . The measurement result will be refreshed every second.

The distance measurement result is displayed in the screen center and will disappear after 10 seconds. When "Horizontal Distance" option enabled, the horizontal distance will be displayed on the second line with symbol Δ . If the distance measurement fails or cannot reach a valid value, "000" will be displayed.

2.2.17 NETWORK CONFIGURATION

Connect your phone to the WiFi hotspot of the rifle scope, you can configure the parameters and realize functions of the device.

1. Enter the  **Advanced Settings** menu.
2. Press  or  button to select  **Network** menu item and press the MENU button  to enable or disable WiFi hotspot.
3. Hold the MENU button  to exit.









Open the AGM Connect APP and connect your phone with the device (refer to Section 2.3). You can view the interface of rifle scope on your phone.

NOTE:

When the power is less than 15%, the WiFi hotspot function will be turned off automatically.









2.2.18 DISPLAY INTERFACE SHAPE (RATTLER V3 LRF 35-384 ONLY)

You can switch between the Circular and Rectangular display interface shape.

1. Enter the  **Advanced Settings** menu.
2. Press  or  button to select  **Display Interface Shape** menu item and press the MENU button  to confirm.
4. Press  or  button **Circular** and **Rectangular** display interface shape and press the MENU button  to confirm.
5. The window "This operation requires restarting the device, continue?" will appear.
 - **OK**: Display interface shape will change.
 - **CANCEL**: Exit without changing the settings.

2.2.19 AUTO SCREEN OFF

Auto screen off function darkens the screen to save energy and increase battery time. However, the device stays on and you can view the live view on AGM Connect app when connecting the device to the app.

1. Enter the  **Advanced Settings** menu.
2. Press  or  button to select  **Auto Screen Off** menu item. Press the MENU button  to enable or disable Auto Screen Off function.
3. Press  or  to select other menu item or hold the MENU button  to exit.

You can use one of the following methods to enter the standby mode when the display is turned on:









- Tilt the device downwards more than 70°.
- Rotate the device horizontally more than 45°.
- Keep the device still and do not move it for 5 minutes.

You can do one of the following methods to wake up the device when the display is turned off:

- Tilt the device downwards from 0° to 60° or upwards .
- Rotate the device horizontally from 0° to 45°.
- Press  to wake up the device.









2.2.20 AUDIO RECORDING SETTING

The Audio function allows you to record sound along with video. If there is too much noise when recording, this function can be disabled.

1. Enter the  **Advanced Settings** menu.
2. Press  or  button to select  **Audio** menu item, and press the MENU button  to enable or disable audio recording.
3. Press  or  to select other menu item or hold the MENU button  to exit.

2.2.21 HOT TRACKING









The device can detect the highest temperature spot in the scene and mark it on display.

1. Enter the  **Advanced Settings** menu.
2. Press  or  button to select  **Hot Tracking** menu item and press the MENU button  to enable/disable hot spot mark (marking the spot of highest temperature).
3. Press  or  to select other menu item or hold the MENU button  to exit.

When the hot spot mark is enabled, the green cross mark -- displays in the spot of the highest temperature. When the scene changes, the green mark moves.

2.2.22 CHANNEL VIEWING ACTIVATION

You can select different palettes to display the same scene in different effects. In the live view mode, press the MENU button  to select a mode (image palette).

1. Enter the  **Advanced Settings** menu.
2. Press  or  button to select  **Compressed** menu, and press the MENU button  to open the options.
3. Press  or  button to select the palette required, and press the MENU button  to enable or disable it.





NOTE:







At least one palette should be enabled.

4. Hold the MENU button  to exit.

2.2.23 ON-SCREEN DISPLAY (OSD)













You can choose which OSD information to display in the live view user interface. Options include, WiFi hotspot activation, current magnification, memory storage status, battery indicator status, time and date. These will appear at the top of the display interface when activated.

1. Enter the  **Advanced Settings** menu.
2. Press  or  button to select  **Function Settings** menu and press the MENU button  to confirm.

3. Press  or  button to select **OSD** OSD submenu and press the MENU button  to enter.
4. Press  or  button to select the **OSD, Time or Date**. Press the MENU button  to display or hide the necessary information.
5. Hold the MENU button  to exit.













2.2.24 PITCH SCALE

You can enable pitch scale to view the device inclination angle in the live view.

1. Enter the  **Advanced Settings** menu.
2. Press  or  button to select  **Function Settings** menu and press the MENU button  to confirm.
3. Press  or  button to select  **Pitch Scale** and press the MENU button  to turn the on-screen pitch scale on or off.
4. Press  or  to select other menu item or hold the MENU button  to exit.













2.2.25 BRAND LOGO

You can display the AGM logo in the lower left corner of the screen.

1. Enter the  **Advanced Settings** menu.
2. Press  or  button to select  **Function Settings** menu and press the MENU button  to confirm.
3. Press  or  button to select  **Brand Logo** menu item. Press the MENU button  to enable/disable logo.
4. Press  or  button to select other item or hold the MENU button  to exit.

2.2.26 USB CONNECTION

The USB port can be used to transfer data to a PC, charge the installed batteries, or casting screen to PC by UVC protocol-based client software or player. You can view the device screen image on the monitor to get a better and clearer image, more convenient to checking the details.















1. Enter the  **Advanced Settings** menu.
2. Press  or  button to select  **Function Settings** menu and press the MENU button  to confirm.
3. Press  or  button to select  **USB Connection** submenu and press the MENU button  to enter the configuration interface.
4. Press  or  button to select **USB Flash Drive** for transfer data or charge the battery, or **Digital** to casting screen to PC.
5. Press the MENU button  to confirm and exit.

2.2.27 IMAGE CALIBRATION

The image calibration function performs what is known as the Flat Field Correction (FFC). This is required of all thermal devices. This can correct for non-uniformity of the display.

RattlerV3 uses shutterless technology. It is based on continuous study of different grey backgrounds, and it is a dynamic correction process that does not lead to loss of image quality. This eliminates the need for periodic calibration pauses, ensuring you never miss a critical moment in the field.















You can also go into the menu and switch to **Semi-Auto** or **Manual** correction mode. During correction an internal shutter will be lowered in front of the thermal detector. A “click” sound will be heard, and the image is momentarily interrupted for a split second. After this quick process the detector will be re-calibrated, and the image becomes more accurate.

1. Enter the  **Advanced Settings** menu.
2. Press  or  button to select  **Function Settings** menu and press the MENU button  to confirm.
3. Press  or  button to select  **Image Calib.** submenu and press the MENU button  to enter.
4. Press  or  button to switch the FFC mode.
Semi-Auto: Hold the LRF button  in live view mode to correct the non-uniformity of display.
Manual: Cover the lens cap, then hold the LRF button  in live view mode to correct the non-uniformity of display.
5. Hold the MENU button  to exit.

2.2.28 DEFECTIVE PIXELS CORRECTION





The Defective Pixel Correction (DPC) can help users repair the occasional deactivated pixel within the display. This is fairly common in thermal optics, which is why so many of these optics come equipped with a DPC feature. 1-3 dead pixels are usually easily repaired by the user. Anything over 3 that cannot be repaired, will open the unit up to an approved warranty repair by AGM at their facility.

Before you start switch the palette to White Hot mode.

1. Enter the  **Advanced Settings** menu.
2. Press  or  button to select  **Function Settings** menu and press the MENU button  to confirm.
3. Press  or  button to select  **DPC** submenu and press the MENU button  to enter.
4. Press the MENU button  to select the X or Y axis.
5. Press  or  button to set the coordinates until the cursor reaches the dead pixel. The screen will display a magnified area around the selected pixel.
6. Press the MENU button  twice to correct the dead pixel.
7. (Optional) Repeat 4 to 6 to correct the position for other dead pixels.
8. Hold the MENU button  to exit.

2.2.29 BURN PREVENTION

This function can prevent damage to the thermal sensor from the sun or other high temperature bright light sources. When enabling this function, the shield will close until the environment turns to normal. This feature may be useful to help protect sensitive displays during extreme summer temperatures. AGM recommends all units be stored in room temperature whenever possible, as long periods of storage in extreme heat (such as inside a vehicle) may lead to issues with the display materials.

1. Enter the  **Advanced Settings** menu.
2. Press  or  button to select  **Function Settings** menu and press the MENU button  to confirm.

3. Press or button to select **Burn Prevention** submenu and press the MENU button to enable or disable the Burn Prevention function.
4. Press or button to select other item or hold the MENU button to exit.

2.2.30 LANGUAGE SETTING

You can select different languages of user interface.

1. Enter the **Advanced Settings** menu.
2. Press or button to select **General Settings** and press the MENU button to confirm.
3. Press or button to select **Language** submenu and press the MENU button to enter.
4. Press or button to select the language as required and press the MENU button to confirm.
5. Hold the MENU button to exit.

2.2.31 TIME SETTING

1. Enter the **Advanced Settings** menu.
2. Press or button to select **General Settings** and press the MENU button to confirm.
3. Press or button to select **Time** submenu and press the MENU button to enter the configuration interface.
4. Press the MENU button to select the hour, minute, second to be synchronized and press or button to change the number.
5. Hold the MENU button to exit.

2.2.32 DATE SETTING

1. Enter the **Advanced Settings** menu.
2. Press or button to select **General Settings** and press the MENU button to confirm.
3. Press or button to select **Date** submenu and press the MENU button to enter the configuration interface.
4. Press the MENU button to select the month, day or year to be synchronized and press or button to change the number.
5. Hold the MENU button to exit.













2.2.33 UNIT SETTING

You can set the unit (yards or meters) of measurement for distance.

1. Enter the **Advanced Settings** menu.
2. Press or button to select **General Settings** and press the MENU button to confirm.
3. Press or button to select **Unit** submenu and press the MENU button to enter the configuration interface.
4. Press or button to select **yd** (yards) or **m** (meters).
5. Hold the MENU button to exit a menu.

2.2.34 AUTO POWER OFF

You can set the time for the automatic shutdown of the device as required.













1. Enter the  **Advanced Settings** menu.
2. Press  or  button to select  **General Settings** and press the MENU button  to confirm.
3. Press  or  button to select  **Auto Power Off** submenu and press the MENU button  to enter the configuration interface.
4. Press  or  button to select OFF, 15 min, 30 min or 45 min.
5. Press the MENU button  to exit.

NOTE:

The auto power off countdown starts again when the device comes out of standby mode or is restarted.









2.2.35 REMOTE ACCESS

This function provides network access to the device (e.g., connection to the AGM Connect App).

1. Enter the  **Advanced Settings** menu.
2. Press  or  button to select  **General Settings** menu and press the MENU button  to confirm.
3. Press  or  button to select  **Remote Access** and press the MENU button  to enable or disable the function.
4. Press  or  button to select other item or hold the MENU button  to exit.









2.2.36 REBOOT

You can reset all the basic settings (Brightness, Contrast, Sharpness, PIP, etc.) to default values.

1. Enter the  **Advanced Settings** menu.
2. Press  or  button to select  **General Settings** and press the MENU button  to confirm.
3. Press  or  button to select  **Reboot** and press the MENU button . The window “Reset the basic settings” will appear.
 - **OK**: Restore the basic settings to defaults.
 - **CANCEL**: Exit without changing the settings.











2.2.37 RESTORE FACTORY SETTINGS

You can reset all device settings and delete all contents of the built-in storage.

1. Enter the  **Advanced Settings** menu.
2. Press  or  button to select  **General Settings** and press the MENU button  to confirm.
3. Press  or  button to select  **Restore Factory Settings** and press the MENU button . The window “Erase all content and settings” will appear.
 - **OK**: Erase all content and restore all settings to defaults.
 - **CANCEL**: Exit without changing the settings.

2.2.38 DIAGNOSTIC LOG



















Diagnostic Log using for recording device status and troubleshooting. You can find the log files in the *log* folder in the device memory and send them to the support service if necessary (see paragraph 2.1.17 about exporting files).

1. Hold the MENU button  to show the menu.
2. Press  or  button to select  **General Settings** and press the MENU button  to confirm.
3. Press  or  button to select  **Diagnostic Log** and press the MENU button . A confirmation window will appear.
4. Select **OK** and press the MENU button  to start recording the log.

2.2.39 PASSCODE

You can set a passcode to lock the device screen and prevent unauthorized access. When the passcode function is enabled, you can customize a 4-digit numerical passcode in the configuration interface.

If a passcode is set, it must be entered when turning on the device or when exiting standby mode.

1. Enter the  **Advanced Settings** menu.
2. Press  or  button to select  **General Settings** and press the MENU button  to confirm.
3. Press  or  button to select  **Passcode** item and press the MENU button  to enter the configuration interface.
4. Press the MENU button  to enable or disable the Passcode function.
5. When passcode enabled, press  or  button to select  **Change Passcode** item and press the MENU button  to set/change passcode. Press the MENU button  to switch digit, and press  or  button to change the number.
6. Hold the MENU button  to exit.









If you forget the passcode, you can hold the Capture button  to reset it on the lock screen. This operation requires a factory reset to the device. The screen lock passcode will be erased when you reset the device.

NOTE:

The device will not appear as a USB drive connecting to the PC when it's turned off or the screen is locked.

2.2.40 VERSION

You can view the device information such as firmware version, serial number and free space of built-in storage.

1. Enter the  **Advanced Settings** menu.
2. Press  or  button to select  **General Settings** and press the MENU button  to confirm.
3. Press  or  button to select  **Version** item and press the MENU button  to confirm. The firmware version, serial number, Security version, Redline info and free space of built-in storage and memory capacity will be displayed.

2.3 CLIENT SOFTWARE INTRODUCTION

Search the AGM Connect software in App Store (iOS System) or Google Play™ (Android System) and install the application on your mobile phone. Turn on the WiFi hotspot on the thermal device and then connect your phone to the hotspot.



- Hotspot Name: Wlan-<Serial No.>

- Hotspot Password: Last 9 digits of Serial Number of your thermal scope.

NOTE:

The device password is set by user at first activation. If the password was lost or forgotten, it can be reset. To reset a password perform the following steps:

1. When the thermal device is turned on, hold the MENU button  to activate the Main menu.

2. Select  Restore Factory Settings item in the General Settings menu and press the MENU button  to restore all parameters to default settings.

1. Run the app and connect the phone or tablet with the device.

2. If the device is inactivated, set the password and activate it. If the device is activated, enter the password to add it to the app.

3. When the device is added, the live view can be seen. You can view the interface of the device on the software. User can change such image parameters as brightness, contrast, zoom, palettes directly via phone or tablet as well as record video on phone/tablet memory.

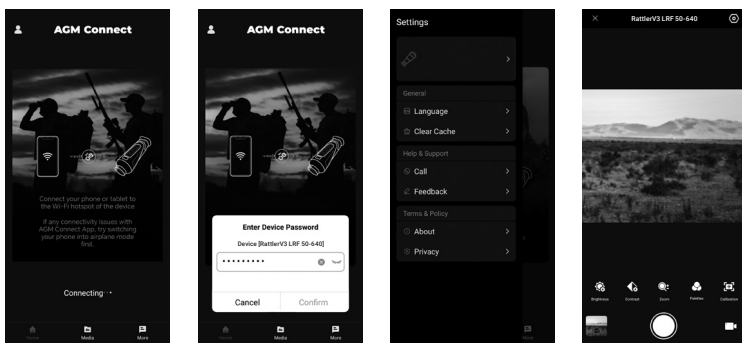

FIGURE 2-9. AGM CONNECT APP

3 MAINTENANCE

3.1 MAINTENANCE

3.1.1 CLEANING PROCEDURES

1. Gently brush off any dirt from the body of the device using a clean, soft cloth.
2. Moisten the cloth with fresh water and gently wipe down the external surfaces (except lenses).
3. Dry any wet surfaces (except lenses) using another dry, clean, soft cloth.
4. Using a lens brush, carefully remove all loose dirt from the lenses.
5. Use a high quality lens wipe to remove dirt or smudges from the lens and display window. Do not use abrasives or solvents to clean the housing, lens, or display window. Clean the glass surfaces using circular movements, starting from the center of the lens and moving out towards the edge.
6. Clean the accessories with a soft brush (or cloth) dampened with soap and water.

3.1.2 PREPARING FOR EXTENDED STORAGE

CAUTION:

Thoroughly dry each item before placing them into the storage case.

To prepare the rifle scope for extended storage:

1. Clean the rifle scope with a damp cloth to remove any dust, dirt or debris.
2. Remove the batteries.
3. Close the lens cap, and place items into their soft carrying case.

3.1.3 UPDATING THE DEVICE FIRMWARE

WARNING:

Please make sure the device is connected to the computer during the entire update process. Otherwise, it may cause unnecessary upgrade failure, firmware damage, etc.

1. Visit www.agmglobalvision.com/firmware website. Select your product, download the firmware update package to your PC and unzip it. Follow the detailed instructions on the website.
2. Connect the device to your PC with USB cable.
3. Turn on the device. Make sure the WiFi hotspot function is disabled.
4. Open the detected disk (USB drive) in file manager program. Copy the unzipped **digicap.dav** file and paste it to the root directory of the device.
5. Turn off the device completely, then power it back on. After awhile, the firmware update process will start automatically. During the update, the screen will display the inscription "Upgrading...". The update process will be completed when the inscription "Upgrading..." goes out.

6. Turn off the device and disconnect it from your PC.

You can also enjoy automatic update function in AGM Connect App (see section 2.3 for details).

1. Start the AGM Connect App and tap the Settings icon in the left top corner.

2. Tap your device in the device list. The information about your device will shown.

3. Tap **Checking for Upgrade** to detect and download the latest FW version.

NOTE:

During the firmware update process, your phone should not go into sleep mode and the screen should remain on at all times. Before updating the firmware via the app, disable automatic lock and screen sleep in your phone's settings.

3.2 TROUBLESHOOTING

Table 3-1 lists the most common malfunctions that may occur with your equipment. This table does not list all the malfunctions that may occur with your device. If the equipment malfunction is not corrected by the suggested actions, or a problem occurs that is not listed in this table, please contact AGM Global Vision's Customer Support center or your retailer.

TABLE 3-1. TROUBLESHOOTING

MALFUNCTION	CORRECTIVE ACTION
The scope fails to activate.	<ol style="list-style-type: none">1. Battery are missing or improperly installed. Insert batteries or install correctly.2. Battery are dead. Replace or charge the battery.3. Battery, surfaces or contacts are dirty or corroded. Clean the contacts.
The scope shut off sometimes after shot.	<ol style="list-style-type: none">1. Low battery level. Check the remaining capacity of the battery, which may be low on power to maintain performance. Replace or charge the battery.
The image is not clear.	Perform the sight adjustment referring to section 2.1.
WiFi is not found.	Examine whether the WiFi function is turned on. If not, turn on the WiFi hotspot in the menu.
Capturing or recording fails.	<ol style="list-style-type: none">1. The device is connected to your PC and has disabled the capturing and recording. Disconnect the device.2. The storage space is full. Delete old files.3. The device is in a low-battery condition. Replace the battery.
The PC cannot identify the scope.	<ol style="list-style-type: none">1. The device is connected to your PC with standard USB cable. If you use other USB cables, make sure the cable length is no longer than 1 m.2. The WiFi function is turned on. If so, turn off the WiFi hotspot in the menu.

4 WARRANTY INFORMATION

4.1 WARRANTY INFORMATION AND REGISTRATION

The below description of AGM Global Vision warranty terms and conditions refer specifically to AGM branded products purchased within the United States. Customers purchasing AGM products outside the United States can obtain specific information about their product's warranty term on the www.agmglobalvision.eu website.

4.1.1 WARRANTY INFORMATION

This product is guaranteed to be free from manufacturing defects in material and workmanship under normal use for a period of five (5) years from the date of purchase. In the event that a defect covered by the warranty below occurs during the applicable period stated above, AGM Global Vision, at its discretion, will either repair or replace the product; such action on the part of AGM Global Vision shall be the full extent of AGM Global Vision's liability, and the Customer's sole and exclusive reparation. This warranty does not cover a product if it has been (a) used in ways other than its normal and customary manner; (b) subjected to misuse; (c) subjected to alterations, modifications or repairs by the Customer or by any party other than AGM Global Vision without prior written consent of AGM Global Vision; (d) is the result of a special order or categorized as "close-out" merchandise or merchandise sold "as-is" by either AGM Global Vision or the AGM Global Vision dealer; or (e) merchandise that has been discontinued by the manufacturer and either parts or replacement units are not available due to reasons beyond the control of AGM Global Vision. AGM Global Vision shall not be responsible for any defects or damage that in AGM Global Vision's view are a result from the mishandling, abuse, misuse, improper storage or improper operation of the device, including use in conjunction with equipment that is electrically or mechanically incompatible with, or of inferior quality to, the product, as well as failure to maintain the environmental conditions specified by the manufacturer. This warranty is extended only to the original purchaser. Any breach of this warranty shall be enforced unless the customer notifies AGM Global Vision at the address noted below within the applicable warranty period.

The customer understands and agrees that except for the foregoing warranty, no other warranties written or oral, statutory, expressed or implied, including any implied warranty of merchantability or fitness for a particular purpose, shall apply to the product. All such implied warranties are hereby and expressly disclaimed.

4.1.2 LIMITATION OF LIABILITY

AGM Global Vision will not be liable for any claims, actions, suits, proceedings, costs, expenses, damages, or liabilities arising out of the use of this product. Operation and use of the product are the sole responsibility of the Customer. AGM Global Vision's sole undertaking is limited to providing the products and services outlined herein in accordance with the terms and conditions of

this Agreement. The provision of products sold and services performed by AGM Global Vision to the Customer shall not be interpreted, construed, or regarded, either expressly or implied, as being for the benefit of or creating any obligation toward any third party of legal entity outside AGM Global Vision and the Customer; AGM Global Vision's obligations under this Agreement extend solely to the Customer. AGM Global Vision's liability hereunder for damages, regardless of the form or action, shall not exceed the fees or other charges paid to AGM Global Vision by the customer or customer's dealer. AGM Global Vision shall not, in any event, be liable for special, indirect, incidental, or consequential damages, including, but not limited to, lost income, lost revenue, or lost profit, whether such damages were foreseeable or not at the time of purchase, and whether or not such damages arise out of a breach of warranty, a breach of agreement, negligence, strict liability, or any other theory of liability.

4.1.3 PRODUCT REGISTRATION

In order to validate the warranty on your product, the customer must complete and submit AGM Global Vision PRODUCT REGISTRATION FORM on our website (www.agmglobalvision.com/customer-support).

4.1.4 OBTAINING WARRANTY SERVICE

To obtain warranty service on your unit, the End-user (Customer) must notify the AGM Global Vision service department via e-mail. Send any requests to support@agmglobalvision.com to receive a Return Merchandise Authorization number (RMA). When returning any device, please take the product to your retailer, or send the product, postage paid and with a copy of your sales receipt, to AGM Global Vision's service center at the address listed above. All merchandise must be fully insured with the correct postage; AGM Global Vision will not be responsible for improper postage or merchandise that becomes lost or damaged during shipment. When sending product back, please clearly write the RMA# on the outside of the shipping box. Please include a letter that indicates your RMA#, the Customer's Name, a Return Address, reason for the return, contact information (valid telephone numbers and/or an e-mail address), and proof of purchase that will help us to establish the valid start date of the warranty. Product merchandise returns that do not have an RMA# listed may be refused, or a significant delay in processing may occur. Estimated Warranty service time is 10-20 business days. The End-user/Customer is responsible for postage to AGM Global Vision for warranty service. AGM Global Vision will cover return postage/shipping after warranty repair to the End-user/Customer only if the product is covered by the aforementioned warranty. AGM Global Vision will return the product after warranty service by domestic UPS Ground service and/or domestic mail. Should any other requested, required, or international shipping methods be necessary, the postage/shipping fee will be the responsibility of the End-user/Customer.

For service, repair or replacement, please contact:

AGM Global Vision, LLC

2407 E Interstate 30, Suite 100

Grand Prairie, TX 75050

Tel. 928.333.4300

support@agmglobalvision.com

www.agmglobalvision.com

5 SPECIFICATIONS

5.1 SPECIFICATIONS

	RATTLER V3 LRF 35-384	RATTLER V3 LRF 35-640	RATTLER V3 LRF 50-640
Image Sensor	12 μ m VOx Uncooled Focal Plane Array	12 μ m VOx Uncooled Focal Plane Array	12 μ m VOx Uncooled Focal Plane Array
Resolution	384 × 288	640 × 512	640 × 512
Refresh Rate	50 Hz	50 Hz	50 Hz
Response Waveband	8 μ m to 14 μ m	8 μ m to 14 μ m	8 μ m to 14 μ m
NETD	Less than 15 mK (@25°C, F# = 1.0)	Less than 15 mK (@25°C, F# = 1.0)	Less than 15 mK (@25°C, F# = 1.0)
Detection Range (6' object)	2480 m (2710 yd)	2480 m (2710 yd)	3540 m (3870 yd)
Lens System	35 mm; F/1.0	35 mm; F/1.0	50 mm; F/1.0
Magnification	3.5x - 28x	2.5x - 20x	3.5x - 28x
Digital Zoom	1x, 2x, 4x, 8x	1x, 2x, 4x, 8x	1x, 2x, 4x, 8x
Field of View (H × V)	7.5° × 4.5° (13.2 × 7.9 m @ 100 m)	12.5° × 10.0° (21.9 × 17.6 m @ 100 m)	8.7° × 7.0° (15.2 × 12.3 m @ 100 m)
Exit Pupil	6 mm	6 mm	6 mm
Eye Relief	45 mm	45 mm	45 mm
Diopter Adjustment	-4D to 3D	-5D to 5D	-5D to 5D
Minimum Focusing Distance	10 m	10 m	15 m
Display	1920 × 1080, 0.49 inch, OLED	2560 × 2560, 1.03 inch, OLED	2560 × 2560, 1.03 inch, OLED
Picture-in-Picture (PiP)	Yes	Yes	Yes
Hot Tracking	Yes	Yes	Yes
Palettes	Black Hot, White Hot, Red Hot, Fusion, Red Monochrome, Green Monochrome	Black Hot, White Hot, Red Hot, Fusion, Red Monochrome, Green Monochrome	Black Hot, White Hot, Red Hot, Fusion, Red Monochrome, Green Monochrome

	RATTLER V3 LRF 35-384	RATTLER V3 LRF 35-640	RATTLER V3 LRF 50-640
Scene Modes	General, Compressed, Auto	General, Compressed, Auto	General, Compressed, Auto
Brightness Adjustment	Yes	Yes	Yes
Contrast Adjustment	Yes	Yes	Yes
Sharpness Adjustment	Yes	Yes	Yes
Tone Adjustment	Cold, Warm	Cold, Warm	Cold, Warm
Image Boost	Image Boost 4.0	Image Boost 4.0	Image Boost 4.0
Zoom Pro	Yes	Yes	Yes
Shutterless Technology	Yes	Yes	Yes
Flat Field Correction (FFC)	Semi-Auto, Manual	Semi-Auto, Manual	Semi-Auto, Manual
Defective Pixels Correction (DPC)	Yes	Yes	Yes
Distance Measurement	Built-In Laser Rangefinder (10 m to 1000 m, ±1 m accuracy)	Built-In Laser Rangefinder (10 m to 1000 m, ±1 m accuracy)	Built-In Laser Rangefinder (10 m to 1000 m, ±1 m accuracy)
Ballistic Calculation	Yes	Yes	Yes
Reticle	10 types, 4 colors, on/off	10 types, 4 colors, on/off	10 types, 4 colors, on/off
Zeroing Profiles	5	5	5
Freeze Zeroing	Yes	Yes	Yes
Inclinometer	Yes	Yes	Yes
WiFi Hotspot	Yes	Yes	Yes
Video Recording	Yes (1920×1080)	Yes (1280×1280)	Yes (1280×1280)
Image Capture	Yes (1920×1080)	Yes (1280×1280)	Yes (1280×1280)
Audio Recording	Yes	Yes	Yes
Shot-Activated Recording (SAR)	Yes	Yes	Yes

	RATTLER V3 LRF 35-384	RATTLER V3 LRF 35-640	RATTLER V3 LRF 50-640
Storage	Built-in EMMC (64 GB)	Built-in EMMC (64 GB)	Built-in EMMC (64 GB)
Video Output	UVC screen casting (via USB Type-C)	UVC screen casting (via USB Type-C)	UVC screen casting (via USB Type-C)
Local Album	Yes	Yes	Yes
Standby Mode	Yes	Yes	Yes
Auto Screen Off	Yes	Yes	Yes
Battery Type	One replaceable rechargeable NE-4400 Li-Ion battery (two batteries included)	One replaceable rechargeable NE-4400 Li-Ion battery (two batteries included)	One replaceable rechargeable NE-4400 Li-Ion battery (two batteries included)
Battery Time (operating)	≥7h (25 °C, hotspot off)	≥5.5h (25 °C, hotspot off)	≥5.5h (25 °C, hotspot off)
External Power Supply	5V DC/2 A, USB Type-C interface	5V DC/2 A, USB Type-C interface	5V DC/2 A, USB Type-C interface
Operating Temperature	-30°C to 55°C (-22°F to 131°F)	-30°C to 55°C (-22°F to 131°F)	-30°C to 55°C (-22°F to 131°F)
Max. Recoil	1000 g/0.4 ms	1000 g/0.4 ms	1000 g/0.4 ms
Protection Level	IP67	IP67	IP67
Dimensions (w/o mount)	229 × 66 × 67 mm (9.0 × 2.6 × 2.6 in)	237 × 66 × 67 mm (9.3 × 2.6 × 2.6 in)	239 × 72 × 70 mm (9.4 × 2.8 × 2.8 in)
Weight (w/o mount and battery)	0.68 kg (1.5 lb)	0.73 kg (1.6 lb)	0.77 kg (1.7 lb)
Safety Class for Laser	Class1	Class1	Class1
Wavelength	905 nm	905 nm	905 nm
Max. Measuring Range	1000 m	1000 m	1000 m
Measurement Accuracy	±1 m	±1 m	±1 m
Min. Measuring Range	10 m	10 m	10 m

All data subject to change without notice.

5.2 RETICLE PARAMETERS

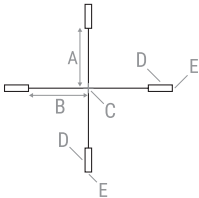
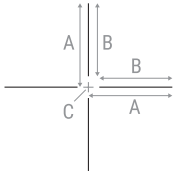
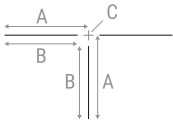
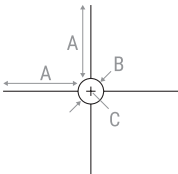
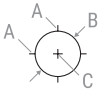

IMAGE	ITEM	MOA	CM @ 100M	IN @ 100YD
	RETICLE 1			
	RattlerV3 LRF 35-384			
	A	70.6	205.2	73.9
	B	71.1	206.7	74.4
	C	1.8	5.1	1.8
	D	14.3	41.6	15.0
	E	4.3	12.4	4.5
	RattlerV3 LRF 35-640			
	A	174.3	507.2	182.5
	B	174.9	508.9	183.1
	C	6.5	18.8	6.8
	D	35.8	104.2	37.5
	E	9.4	27.3	9.8
	RattlerV3 LRF 50-640			
	A	122.3	355.7	128.0
	B	122.7	356.9	128.5
	C	4.5	13.2	4.7
	D	25.1	73.1	26.3
	E	6.6	19.2	6.9
		RETICLE 2		
RattlerV3 LRF 35-384				
A		85.4	248.3	89.4
B		79.8	232.3	83.6
C		1.8	5.1	1.8
RattlerV3 LRF 35-640				
A		210.1	611.5	220.0
B		196.6	572.2	205.9
C		4.7	13.7	4.9
RattlerV3 LRF 50-640				
A		147.4	428.8	154.3
B		137.9	401.3	144.4
C	3.3	9.6	3.5	
	RETICLE 3			
	RattlerV3 LRF 35-384			
	A	85.4	248.3	89.4
	B	80.1	233.0	83.9
	C	1.8	5.1	1.8
	RattlerV3 LRF 35-640			
	A	210.1	611.5	220.0
	B	196.6	572.2	205.9
	C	4.7	13.7	4.9
	RattlerV3 LRF 50-640			
	A	147.4	428.8	154.3
	B	137.9	401.3	144.4
C	3.3	9.6	3.5	

IMAGE	ITEM	MOA	CM @ 100 M	IN @ 100 YD
	RattlerV3 LRF 35-384			
	A	66.8	194.3	69.9
	B	60.5	176.0	63.4
	C	15.8	77.8	16.6
	D	2.8	8.0	2.9
	E	19.1	98.2	20.0
	F	1.8	5.1	1.8
	G	2.8	8.0	2.9
	H	2.8	8.0	2.9
	I	1.8	5.1	1.8
	J	3.3	9.5	3.4
	K	2.3	6.6	2.4
	RattlerV3 LRF 35-640			
	A	129.1	375.7	135.2
	B	149.1	433.8	156.1
	C	38.2	77.8	39.9
	D	7.0	20.5	7.4
	E	48.1	98.2	50.4
	F	3.5	10.2	3.7
	G	11.2	32.4	11.7
	H	11.2	32.4	11.7
	I	6.5	18.8	6.8
	J	5.9	17.1	6.1
	K	4.7	13.7	4.9
	RattlerV3 LRF 50-640			
	A	90.6	263.5	94.9
	B	104.6	304.2	109.5
	C	26.8	77.8	28.1
	D	4.9	14.4	5.1
	E	33.8	98.2	35.4
	F	2.5	7.2	2.6
	G	7.8	22.8	8.2
	H	7.8	22.8	8.2
I	4.5	13.2	4.7	
J	4.1	12.0	4.3	
K	3.3	9.6	3.5	

IMAGE	ITEM	MOA	CM @ 100 M	IN @ 100 YD
	RattlerV3 LRF 35-384			
	A	2.3	6.6	2.4
	B	2.5	7.3	2.6
	C	0.8	2.2	0.8
	D	0.5	1.5	0.5
	RattlerV3 LRF 35-640			
	A	4.7	13.7	4.9
	B	5.9	17.1	6.1
	C	2.4	6.8	2.5
	D	1.2	3.4	1.2
	RattlerV3 LRF 50-640			
	A	3.3	9.6	3.5
	B	4.1	12.0	4.3
	C	1.7	4.8	1.8
	D	0.8	2.4	0.9
		RattlerV3 LRF 35-384		
A		4.8	13.9	5.0
B		0.8	2.2	0.8
RattlerV3 LRF 35-640				
A		10.6	30.7	11.1
B		2.4	6.8	2.5
RattlerV3 LRF 50-640				
A		7.4	21.6	7.7
B		1.7	4.8	1.8

IMAGE	ITEM	MOA	CM @ 100 M	IN @ 100 YD
	RattlerV3 LRF 35-384			
	A	92.4	268.8	96.7
	B	77.8	226.4	81.5
	C	17.1	49.7	17.9
	D	2.0	5.8	2.1
	E	2.3	6.6	2.4
	F	2.0	5.8	2.1
	G	3.0	8.8	3.2
	H	2.8	8.0	2.9
	I	4.0	11.7	4.2
	J	6.0	17.5	6.3
	RattlerV3 LRF 35-640			
	A	216.0	628.6	226.2
	B	182.0	529.4	190.5
	C	39.9	116.1	41.8
	D	4.7	13.7	4.9
	E	5.3	15.4	5.5
	F	4.7	13.7	4.9
	G	7.0	20.5	7.4
	H	6.5	18.8	6.8
	I	9.4	27.3	9.8
	J	14.1	41.0	14.7
	RattlerV3 LRF 50-640			
	A	151.5	440.8	158.6
	B	127.6	371.3	133.6
	C	28.0	81.4	29.3
	D	3.3	9.6	3.5
	E	3.7	10.8	3.9
	F	3.3	9.6	3.4
	G	4.9	14.4	5.2
	H	4.5	13.2	4.7
	I	6.6	19.2	6.9
	J	9.9	28.7	10.3

IMAGE	ITEM	MOA	CM @ 100 M	IN @ 100 YD
	RattlerV3 LRF 35-384			
	A	76.6	222.8	80.2
	B	18.3	53.3	19.2
	C	1.8	5.1	1.8
	RattlerV3 LRF 35-640			
	A	186.7	543.1	195.4
	B	48.7	141.7	51.0
	C	4.7	13.7	4.9
	RattlerV3 LRF 50-640			
	A	130.9	380.9	137.1
	B	34.2	99.4	35.8
	C	3.3	9.6	3.4
		RattlerV3 LRF 35-384		
A		2.0	5.8	2.1
B		18.3	53.3	19.2
C		1.8	5.1	1.8
RattlerV3 LRF 35-640				
A		4.7	13.7	4.9
B		42.8	124.6	44.9
C		4.1	12.0	4.3
RattlerV3 LRF 50-640				
A		3.3	9.6	3.4
B		30.5	88.6	31.9
C		2.9	8.4	3.0
		RattlerV3 LRF 35-384		
	A	3.3	9.5	3.5
	RattlerV3 LRF 35-640			
	A	7.6	22.2	8.0
	RattlerV3 LRF 50-640			
	A	5.8	16.8	6.1

All data subject to change without notice.

NOTE:

The scale intervals of the Reticle 4 and Reticle 7 change synchronously under the current digital zoom.



AGM Global Vision, LLC

MAIN OFFICE

2407 E Interstate 30,
Suite 100

Grand Prairie, TX 75050

USA

Tel. +1.928.333.4300

info@agmglobalvision.com

www.agmglobalvision.com

EUROPEAN OFFICE

#6 Andrey Lyapchev Blvd

Sofia, P.C. 1756

Bulgaria

Tel. +35.988.560.0326

info@agmglobalvision.eu

www.agmglobalvision.eu

DOWNLOAD AGM CONNECT APP:



Google Play Store



Apple App Store

AGMglobalvision.com