

# **RATTLER V<sup>3</sup>**

## **25-384**

THERMAL IMAGING RIFLE SCOPE

**USER MANUAL**

© 2025 AGM Global Vision, LLC. All rights reserved.

This documentation is subject to change without notice.

No parts of this manual, in whole or in part, may be copied, photocopied, translated, or transmitted by any electronic medium or in machine-readable form without the prior written permission of AGM Global Vision, LLC.

If you have questions that are not covered in this manual, or need service, contact AGM Global Vision customer support for additional information prior to returning a product.

## **AGM Global Vision, LLC**

**2407 E Interstate 30, Suite 100**

**Grand Prairie, TX 75050**

**Tel. 928.333.4300**

**support@agmglobalvision.com**

**www.agmglobalvision.com**

## **EXPORT INFORMATION**

Buyer acknowledges that all products supplied by AGM Global Vision, LLC are subject to U.S. export control laws, including, but not limited to, the Export Administration Regulations, the International Traffic in Arms Regulations, the International Economic Emergency Powers Act, and various U.S. embargoes and sanctions. AGM Global Vision products may not be exported, re-exported, or transferred contrary to U.S. export control laws. In particular, AGM Global Vision products may not be exported, re-exported, or transferred to prohibited countries, individuals, organizations, or entities, including but not limited to those individuals and entities listed on the List of Specially Designated Nationals and Blocked Persons administered or maintained by the U.S. Office of Foreign Assets Control ("OFAC"), the various lists maintained by the Bureau of Industry and Security of the Department of Commerce, and the U.S. State Department and Buyer represents and warrants that neither Buyer nor any of its officers, directors, or employees are on such lists. Distribution or resale by Buyer to such countries, individuals, organizations, or entities is expressly prohibited. Buyer has and will maintain a positive process to ensure compliance with this Section.

## FCC INFORMATION

Please note that changes or modification not expressly approved by the party responsible for compliance could void the user's authority to operate the equipment.

This equipment complies with FCC/IC RSS-102 radiation exposure limits set forth for an uncontrolled environment.



FCC compliance: This product has been tested and found to comply with the limits for a Class B digital device, pursuant to Part 15 of the FCC Rules. These limits are designed to provide reasonable protection against harmful interference in a residential installation. This product generates, uses, and can radiate radio frequency energy and, if not installed and used in accordance with the instructions, may cause harmful interference to radio communications. However, there is no guarantee that interference will not occur in a particular installation. If this product does cause harmful interference to radio or television reception, which can be determined by turning the equipment off and on, the user is encouraged to try to correct the interference by one or more of the following measures:

- Reorient or relocate the receiving antenna.
- Increase the separation between the equipment and receiver.
- Connect the equipment into an outlet on a circuit different from that to which the receiver is connected.
- Consult the dealer or an experienced radio/TV technician for help.

### FCC Conditions

This device complies with part 15 of the FCC Rules. Operation is subject to the following two conditions:

1. This device may not cause harmful interference.
2. This device must accept any interference received, including interference that may cause undesired operation.

## EU CONFORMITY STATEMENT



This product and - if applicable - the supplied accessories too are marked with "CE" and comply therefore with the applicable harmonized European standards listed under the EMC Directive 2014/30/EU, the RoHS Directive 2011/65/EU



2012/19/EU (WEEE directive): Products marked with this symbol cannot be disposed of as unsorted municipal waste in the European Union. For proper recycling, return this product to your local supplier upon the purchase of equivalent new equipment, or dispose of it at designated collection points. For more information see: [www.recyclethis.info](http://www.recyclethis.info)



Regulation (EU) 2023/1542 (Battery Regulation): This product contains a battery and it is in conformity with the Regulation (EU) 2023/1542. The battery cannot be disposed of as unsorted municipal waste in the European Union. See the product documentation for specific battery information. The battery is marked with this symbol, which may include lettering to indicate cadmium (Cd), or lead (Pb). For proper recycling, return the battery to your supplier or to a designated collection point. For more information see: [www.recyclethis.info](http://www.recyclethis.info)

# LIST OF CONTENTS

TITLE	PAGE
Safety Summary	5
<b>1. GENERAL INFORMATION</b>	<b>8</b>
1.1 System Description	8
1.2 Key Features	9
<b>2. OPERATING INSTRUCTIONS</b>	<b>10</b>
2.1. Basic Operations	10
2.2 Main Function	17
2.3 Client Software Introduction	33
<b>3. MAINTENANCE</b>	<b>34</b>
3.1 Maintenance	34
3.2 Troubleshooting	35
<b>4. WARRANTY INFORMATION</b>	<b>36</b>
4.1 Warranty Information and Registration	36
<b>5. SPECIFICATIONS</b>	<b>38</b>
5.1 Specifications	38
5.2 Reticle Parameters	40

## SAFETY SUMMARY

- Read and follow all instructions
- Read all warnings
- Only use the attachments/accessories specified by the manufacturer
- All service must be provided by the manufacturer

### WARNINGS:

- This product contains natural rubber latex, which may have the potential to cause allergic reactions. If you are allergic to latex, it is important that you strictly avoid exposure to products that contain it.
- Always make sure your firearm is unloaded before you place the optic on the firearm. Reconfirm that the chamber is empty if you are forced to stop at anytime before completing the zeroing in process. Safe handling rules should be followed at all times.
- If a scope is mounted too far to the rear, the eyepiece may cause an impact injury to the shooter's eye socket. Shooting at an uphill angle also increases this hazard because it shortens the distance between the eyebrow and the rear of the scope. For this reason, AGM scopes are engineered to provide generous eye relief. Therefore, when mounting your scope, we recommend positioning it as far forward in the mounts as possible to take full advantage of this generous eye relief. With hard-recoiling rifles, serious injury or even death can result from eyepiece impact with the shooter during the recoil process when discharging the firearm. Be certain that your installation provides sufficient eye relief for the recoil generated by your rifle before shooting the firearm.

### NOTE:

Give special attention to this warning when shooting uphill and/or from a prone position. These shooting conditions can dramatically reduce eye relief. PLEASE maintain maximum eye relief when shooting heavy recoiling and/or magnum firearms. THE USER ASSUMES ALL RESPONSIBILITY AND LIABILITY FOR HAVING THE AGM RIFLE SCOPE PROPERLY MOUNTED TO A FIREARM AND USING THE AGM RIFLE SCOPE PROPERLY. ALWAYS CHECK THE CONDITION OF YOUR MOUNTING SYSTEM PRIOR TO USING YOUR FIREARM.

### SAFETY INSTRUCTIONS:

#### Transportation

- Keep the device in original or similar packaging while transporting it.
- Keep all wrappers after unpacking them for future use. In case of any failure occurred, you need to return the device to the factory with the original wrapper. Transportation without the original wrapper may result in damage on the device and the company shall not take any responsibilities.
- Do not drop the product or subject it to physical shock. Keep the device away from magnetic interference.

## Power Supply

- If a power adapter is provided in the device package, use the provided adapter only. If no power adapter is provided, ensure the power adapter or other power supply complies with Limited Power Source (5 VDC/2 A). Refer to the product label for the power supply output parameters.
- Make sure the plug is properly connected to the power socket.
- DO NOT connect multiple devices to one power adapter, to avoid overheating or fire hazards caused by overload.

## Battery

- The device supports removable NE-4400 rechargeable Li-Ion battery. The charging limited voltage of the battery is 4.2V. The battery voltage and capacity is 3.6V/4.4Ah (15.84 Wh).
- The purchased batteries by users need to comply with the relevant international standards about battery safety (e.g. EN/IEC standards).
- Improper use or replacement of the battery may result in explosion hazard. Replace with the same or equivalent type only.
- Batteries of improper size cannot be installed, and may cause abnormal shutdown.
- Dispose of used batteries in conformance with the instructions provided by the battery manufacturer.
- Make sure the battery temperature is between 0°C to 45°C (32°F to 113°F) when charging.
- For long-term storage of the battery, make sure it is fully charged every half year to ensure the battery quality. Otherwise, damage may occur.
- Do not charge other battery types with the supplied charger. Confirm there is no flammable material within 2 m of the charger during charging.
- Do not dispose of the battery into fire or a hot oven, or mechanically crush or cut the battery, which may result in an explosion.
- Do not leave the battery in an extremely high temperature or low air pressure environment, which may result in an explosion or the leakage of flammable liquid or gas.
- DO NOT place the device with battery or the battery alone near heating or fire source. Avoid direct sunlight.
- If the battery compartment does not close securely, stop using the product and keep it away from children.
- DO NOT disassemble the battery.
- DO NOT place the battery in the reach of children.
- This device is not suitable for use in locations where children are likely to be present.

## **Maintenance**

- If the product does not work properly, please contact your dealer or the nearest service center. We shall not assume any responsibility for problems caused by unauthorized repair or maintenance.
- Make sure that the power has been disconnected before device teardown and repair by professionals.
- Wipe the device gently with a clean cloth and a small quantity of ethanol, if necessary.
- If the equipment is used in a manner not specified by the manufacturer, the protection provided by the device may be impaired.
- Clean the lens with soft and dry cloth or wiping paper to avoid scratching it.

## **Using Environment**

- Make sure the running environment meets the requirement of the device. The operating temperature shall be  $-30^{\circ}\text{C}$  to  $55^{\circ}\text{C}$  ( $-22^{\circ}\text{F}$  to  $131^{\circ}\text{F}$ ), and the operating humidity shall be from 5% to 95%.
- DO NOT expose the device to high electromagnetic radiation or dusty environments.
- DO NOT aim the lens at the sun or any other bright light.
- Place the device in a dry and well-ventilated environment.
- Avoid equipment installation on vibratory surface.
- When any laser equipment is in use, make sure that the device lens is not exposed to the laser beam, or it may burn out.
- This equipment is not suitable for use in locations where children are likely to be present.

## **NOTES:**

- The detector spectral band provides better visibility through smoke, dust, rain, smog, etc.
- Infrared radiation does not travel through glass. As a result, the rifle scope does not detect objects if they are behind glass windows or other barriers.

# 1 GENERAL INFORMATION

## 1.1 SYSTEM DESCRIPTION

The Rattler series of thermal riflescopes has long been the most popular thermal rifle scope product family in the country, and the new RattlerV3 series is just another step forward in that development. The RattlerV3 25-384 model pairs a 25mm lens with an industry-leading sub-15mK thermal sensor and a new, larger, 1920x1080 high resolution display. This new 1920 resolution display also affords users the ability to switch from a semi-circular interface to a rectangular interface, the first of its kind in thermal riflescopes. The RattlerV3 series is also the first in the Rattler family to feature a shutterless NUC'ing system, AGM's powerful new Image Boost 2.0 algorithm, new red & green monochrome color palettes and the ability of users to view photos/videos directly on the device without having to export them first.

Although the differences are numerous, we were sure to keep many of the same physical features that RattlerV2 users have learned to love: large sturdy buttons for cold weather conditions, a compact housing and the same removable rechargeable NE-4400 battery system. The firmware package allows users an amazing level of customization: on-board pitch scale, 10 brightness and contrast settings, warm & cold viewing modes, recoil-activated video with sound, picture in picture, WiFi hotspot, multiple zeroing profiles, defective pixel repair and hotspot locator. AGM - Vision Without Limits.

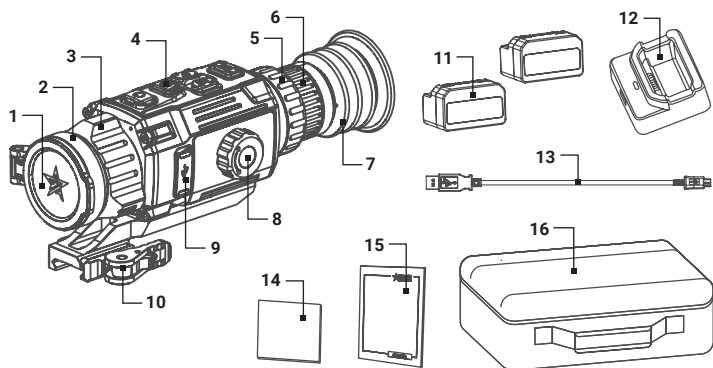

FIGURE 1-1. MAIN PARTS AND COMPONENTS

**TABLE 1-1. MAIN PARTS AND COMPONENTS**

ITEM	DESCRIPTION	ITEM	DESCRIPTION
1	Lens Cover	9	USB Type-C Interface
2	Lens	10	Mount*
3	Lens Focusing Ring	11	NE-4400 Li-Ion Battery (2)
4	Operation Buttons	12	NE-4400 Charger
5	Ocular	13	USB Cable
6	Diopter Adjustment Ring	14	Lens Tissue
7	Eyecup	15	User Manual & QSG
8	Battery Compartment	16	Carrying Case

\* The mounting system depends on the region of sale.

## 1.2 KEY FEATURES

- 12 micron detector with 384x288 resolution
- Sub-15mK thermal sensitivity
- Shutterless NUC technology
- Various reticle types and colors
- 1x, 2x, 4x, 8x digital zoom
- Large OLED display with 1920x1080 resolution
- On-board video/audio recording and image capture
- UVC screen casting via USB Type-C interface
- Shot Activated Recording (SAR) function
- Built-in EMMC storage (64 GB)
- WiFi data transmission
- Standby mode
- More than 7 hours of battery life
- External power supply compatibility
- Waterproof & shockproof

## 2 OPERATING INSTRUCTIONS

### 2.1. BASIC OPERATIONS

#### 2.1.1 UNPACKING

The following steps must be completed prior to each use.

1. Open the carrying case, remove the device, and verify that all components are included.
2. Inspect the device for any signs of damage to the optical surfaces, body, eyecup, operation buttons, etc. Ensure that all optical surfaces are clean and ready for use. Once the diopter is set, all focusing of the image upon use of the digital zoom will occur via the lens focus knob, which is the rotating knob closest to the objective lens of the scope.

#### 2.1.2 BATTERY INSTRUCTION

1. The device supports a removable NE-4400 Li-Ion rechargeable battery. The battery voltage is 3.6V and the capacity is 4.4Ah (15.84 Wh). The battery charging voltage is limited to 4.2V.
2. Before first use, charge the battery to full capacity using the NE-Charger. You can also charge the battery installed in the device using an external 5V/2A power adapter via the scope's USB port.
3. Be sure to remove the battery when storing the device for long periods of time.

#### 2.1.3 BATTERY INSTALLATION

##### **CAUTION:**

Verify that the device is turned off before removing the battery.

To install the battery (refer to Figure 2-1):

1. Turn the battery cover knob (A) counter clockwise and then open the battery cover (B).

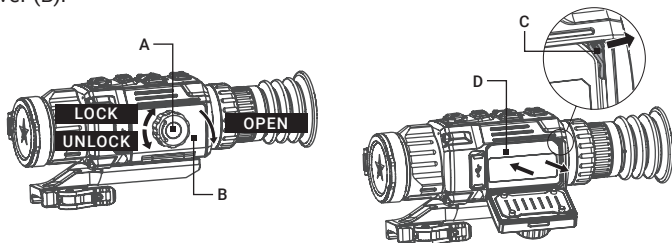

FIGURE 2-1. BATTERY INSTALLATION

2. Push the red latch (C) aside (as the arrow shows), and release the battery.
3. Insert the battery (D) into the battery compartment. The latch locks the battery in place when the battery is fully inserted.
4. Once the battery is locked into place, close the battery door until a “click” is heard, or felt. This means the internal battery door lever is engaged with the housing to secure the battery door in place.

## 2.1.4 CONTROL BUTTONS

The RattlerV3 controls are shown in Figure 2-2 and are defined in Table 2-1. Each button is responsible for some functions selected by short press or long press of the button. Pushing a button for 3+ second is considered “long press/hold.”

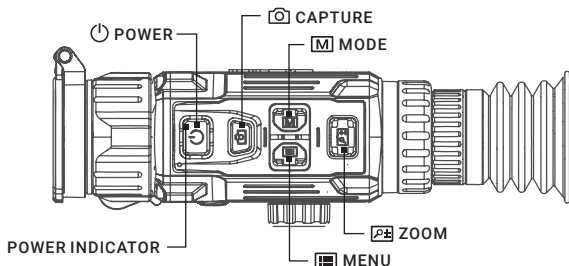







FIGURE 2-2. CONTROL BUTTONS

TABLE 2-1. BUTTON FUNCTIONS

BUTTON	FUNCTIONS
 POWER	Press: Standby Mode/Wake Up Device Long Press: Power On/Off
 MENU	Press: Enter the Main Menu <b>MENU MODE</b> Press: Confirm/Set Parameters Long Press: Exit the Menu
 MODE	Press: Palette Switching Long Press: Correct Non-uniformity of Display (FFC)
 CAPTURE	Press: Image Capture Long Press: Start/Stop Video Recording <b>MENU MODE</b> Press: Up/Change Parameters
 ZOOM	Press: Switching Digital Zoom Long Press: Enable/Disable PIP Mode <b>MENU MODE</b> Press: Down/Change Parameters

## 2.1.5 POWER ON AND OFF

### Power On

With the battery installed, press and hold the POWER button to turn on the device. The LED power indicator in the POWER button will light up.

### Power Off

When the device is turned on, hold the POWER button  to turn off the device.



### Auto Power Off

In the “Auto Power Off” submenu of General Settings you can set the time for the automatic shutdown of the device as required (see 2.2.33 for details).

The Auto Power Off countdown will start again when the device exits standby mode, or the device is restarted.

## 2.1.6 STANDBY MODE

Standby mode is used to save battery power. In this mode, some power-consuming features such as the display, network hardware, or internal storage will be temporarily disabled.

In the view mode, press the POWER button . After a few seconds, the display will turn off. Press the POWER button  again to exit the Standby mode.

## 2.1.7 VIEWING THE THERMAL IMAGE

1. Power on the rifle scope.
2. Open the lens cover, bring the scope to your eye and make sure the eyecup covers your eye. The internal display will show the thermal image and on-screen interface.
3. Use the diopter adjustment ring (rotating ring closest to your eye) to ensure that the on-screen interface elements are crisp and sharp. Once completed, this adjustment will not be needed again until a new user is using the device.
4. Once the diopters are set, all image focusing for various distances will occur using the front lens focusing ring.

### NOTE:

**You must perform the focus adjustment before any further use of the scope.**

5. Set palette, brightness, contrast, sharpness, tone, and scene mode to display the best image effect.

## 2.1.8 ON-SCREEN DISPLAY

On-screen interface displays the menu items and device status indicators.

Use the MENU button  in the view mode to display or hide the menu.

Adjust the On-Screen Display (OSD) in the Function Settings menu (see 2.2.22).

When OSD is on, the information of Shot Activated Recording (SAR) function, WiFi hotspot activation, battery status, current magnification setting, time and date displays on the screen.

The screen can also display the reticle, current zeroing profile, zeroing distance, distance measurement result and the pitch scales. You can configure the display of all these elements in the scope's menu.

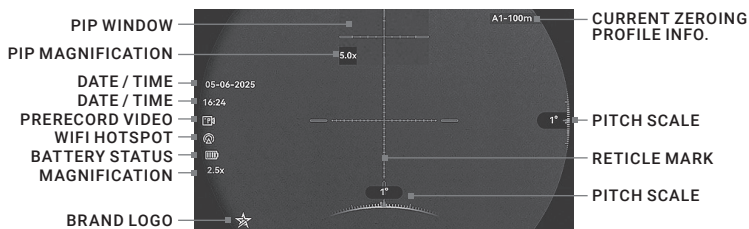

FIGURE 2-3. ON-SCREEN DISPLAY

## 2.1.9 PALETTE SETTINGS

You can select different palettes to display the same scene in different effects. In the live view mode, press the MODE button **[M]** to select a mode (image palette).

TABLE 2-2. PALETTE SETTINGS

PALETTE	DESCRIPTION
WHITE HOT	The hot part is displayed in white. The higher the temperature, the lighter the color.
BLACK HOT	The hot part is displayed in black. The higher the temperature, the darker the color.
FUSION	The hot part is displayed in white. From high temperature to low temperature, the image is colored in from white, yellow, red, pink to purple.
RED HOT	The hottest part is displayed in red, the rest of the image will be flushed out in shades of gray.
RED MONOCHROME	The image is colored in shades of red. The higher the temperature, the lighter the color.
GREEN MONOCHROME	The image is colored in shades of green. The higher the temperature, the lighter the color.

### 2.1.10 DIGITAL ZOOM

Press the ZOOM button **[Z]** in the view mode to switch between 1x, 2x, 4x and 8x digital zoom. The image magnification value is displayed on the screen: 2.5x, 5x, 10x, 20x.

### 2.1.11 PICTURE IN PICTURE

The Picture-in-Picture (PIP) mode allows you to see simultaneously both a magnified image of the central part in a PIP window and the main image. The PIP window is displayed at the up-center of the live view. In the live view you can enable or disable the PIP function by holding the ZOOM button **[Z]**.

The PIP window at the top of the screen displays the details of central part of the image. When you change the zoom level, the current PIP magnification is displayed in the corner of the PIP window.

## NOTE:

- When the reticle is enabled, the PIP view displays a magnified area around the center of the crosshair. When the reticle is not enabled, the PIP view displays a magnified central area of the image.
- If the PIP function is activated, the image will be enlarged by the zoom factor only in the PIP window.

### 2.1.12 IMAGE CALIBRATION

RattlerV3 uses shutterless technology. It is based on continuous study of different grey backgrounds, and it is a dynamic correction process that does not lead to loss of image quality. This eliminates the need for periodic calibration pauses, ensuring you never miss a critical moment in the field.

You also can use **Manual** or **Semi-Auto** option to correct the non-uniformity of display when necessary. Hold the MODE button **[M]** in the view mode to correct the non-uniformity of display. See part 2.2.27 for more details on the Flat Field Correction function.

### 2.1.13 VIDEO RECORDING AND IMAGE CAPTURE

#### Video Recording

Hold the CAPTURE button **[📷]** in the view mode and start recording. In the upper left corner, the recording time displays.

Hold the CAPTURE button **[📷]** again to stop recording.

#### Image Capture

Press the CAPTURE button **[📷]** in the view mode, to capture the image.

## NOTE:

When captured, the image freezes for 1 second and a prompt shows on the display.

### 2.1.14 CONNECTING THE DEVICE

1. Open the USB interface cover.
2. Connect the device and power adapter with a USB Type-C cable to charge the battery installed in the device. You can also power the device using an external power source via the USB port. Alternatively, you may also connect the device to your computer using the included USB cable to copy/delete files. Or, your image and video content can be managed through the AGM Connect phone application.

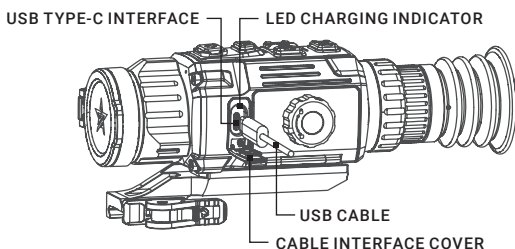

FIGURE 2-4. CABLE INTERFACE

The LED indicator near the USB port indicates the following statuses:

**Solid Red:** the device is properly charged.

**Solid Green:** the device is fully charged.

**Flashing Red & Green:** the battery is not installed and the device is powered by an external power supply / an error has occurred.

**Off:** device is not charged.

### 2.1.15 FILE EXPORT

1. Before connecting the thermal rifle scope to a computer, please make sure that the WiFi function of the rifle scope is disabled.
2. Connect the thermal rifle scope to your PC with USB cable and open the detected disk.
3. The directory is named by the current date. Enter **AGM Content > "Date"** to view the videos and snapshots.
  - Select and copy the videos to PC and play the file with the player.
  - Select and copy the snapshots to PC and view the files.
4. Disconnect the device from your PC.

#### **NOTE:**

- The device displays images when you connect it to PC. But functions such as recording, capturing and hot spot are disabled.
- When you connect the device to PC for the first time, it installs the driver automatically.

### 2.1.16 INSTALLATION ON PICATINNY/WEAVER RAIL

#### **WARNING:**

Always make sure your firearm is unloaded before you place the scope on the firearm. Reconfirm that the chamber is empty if you stop the procedure then resume later. Safe firearms handling rules should be followed at all times.

The RattlerV3 comes with a Picatinny/Weaver mount. The mount is secured to the scope with two screws. The recommended tightening torque for the fixing screws is 4-5.3 Nm (35.4-46.9 in-lbs).

#### **NOTE:**

Mount model depends on the region of sale. Different models of mounts may have different designs.

To install the RattlerV3 on a Picatinny/Weaver rail, perform the following:

1. Unlock the clamping device of the scope mount by pushing down on the lever holder (A) and unlocking the lever (B).
2. Install the scope on the Picatinny/ Weaver rail so that the stop (C) slides into the transverse slot on the rail.
3. Affix the scope to the rail by locking the lever (B).
4. Verify that the clamping device is firmly holding the RattlerV3. If necessary, adjust the clamping device's lever-cam lock as detailed in part 2.1.19.

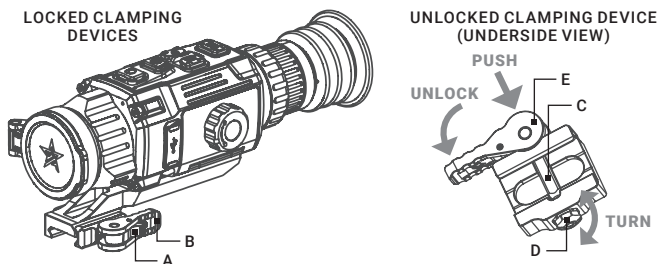

FIGURE 2-5. MOUNT

### 2.1.17 CLAMPING DEVICE ADJUSTMENT

To adjust the mount's clamping device, do the following:

1. Remove the RattlerV3 from the rail.
2. With the clamping device unlocked (as shown in Figure 2-5), push the cam (E) towards the arrow, which will cause the nut (D) to slide out of its hole.
3. To tighten/ loosen the clamping device, push down on the cam (E) and turn the nut (D) CW/ CCW respectively, in one-two increments (see note below). Much like when the cam (E) is released, backward-moving spring will cause the nut (D) to slide back into its hole.

**NOTE:**



The eight-sided nut of the mount lever-cam lock will only fit into their hole if turned in one of the discrete positions, using increments equal to  $360^{\circ}/8$ .

4. Verify that the adjusted lever-cam lock securely holds the mounting rail.

## 2.2 MAIN FUNCTIONS

### 2.2.1 MAIN MENU

In the live view mode, press the MENU button  to display the Main Menu. In the Main Menu, you can set parameters such as Brightness, Contrast, PIP (Picture in Picture), and also select the Advanced Menu for additional settings.

Press  or  buttons to move between menu items. The active element is highlighted. Press the MENU button  to select menu item or change an option.

Hold the MENU button  to exit the menu.

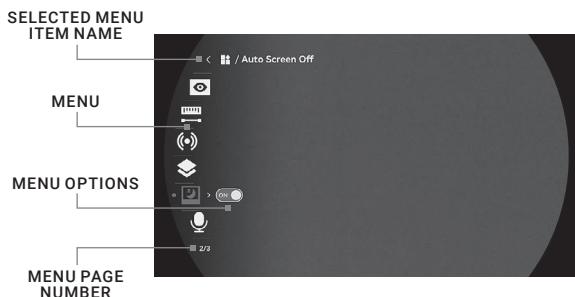

















































FIGURE 2-6. MAIN MENU









TABLE 2-3. MENU FUNCTIONS

MENU ITEM	SYMBOL	OPTION	FUNCTION
<b>BRIGHTNESS</b>		10 Levels of Brightness	Adjusts the image brightness.
<b>CONTRAST</b>		10 Levels of Contrast	Adjusts the image contrast.
<b>SHARPNESS</b>		5 Levels of Sharpness	Adjusts the image sharpness.
<b>ZOOM PRO</b>		OFF / ON	Enables or disables the Zoom Pro function.
<b>ADVANCED SETTINGS</b>		<b>Advanced Settings Menu:</b>	
<b>ZEROING PROFILES</b>		5 Profiles (A/B/C/D/E)	Zeroing profile selection with user saved zeroing settings.
<b>ZEROING</b>		<b>Zeroing Menu:</b>	
Zeroing		OFF / 1 / 2 / 3 / 4 / 5	Zeroing settings selection or disable reticle.
Bullet		Bullet Name	Setting the bullet name (9 characters).
Type		10 Reticle Type	Setting the reticle type.







MENU ITEM	SYMBOL	OPTION	FUNCTION
Reticle Color		4 Reticle Colors	Setting the reticle color (white, red, green, black).
Reticle Center Color		4 Reticle Center Colors	Setting the reticle center color (white, red, green, black).
Correction		<b>Boresight Correction Menu:</b>	
Distance		Distance to the target	Setting the distance to the target.
Zoom		2.5x / 5x / 10x / 20x	Setting the magnification with Digital Zoom.
Freeze Screen		OFF / ON	Image freeze.
X/Y Axis		X / Y	Switching the X and Y axes of correction. Setting the correction.
<b>ALBUMS</b>		---	View/Delete local files.
<b>RETICLE MODE</b>		Fixed Reticle / Central Reticle	You can select a reticle mode according to your preference and different situations
<b>PRERECORD</b>		OFF / 5s / 10s / 15s	Setting the recording time before and after the recoil activation.
<b>TONE</b>		Cold / Warm	Switch between the Cold mode and Warm mode.
<b>SCENE MODE</b>		General / Compressed	Switch between the General mode and Compressed mode.
<b>MEASURE</b>		Target: Deer, Grey Wolf, Brown Bear, and Custom	Measures the distance between the target and the observation position.
<b>NETWORK</b>		Close / Hotspot	Enables or disables the WiFi hotspot.
<b>DISPLAY INTERFACE SHAPE</b>		Circular / Rectangular	Switch between the Circular and Rectangular display interface shape.
<b>AUTO SCREEN OFF</b>		OFF / ON	Function darkens the screen to save energy.
<b>AUDIO</b>		OFF / ON	Enable or disable audio recording.
<b>HOT TRACKING</b>		OFF / ON	Enables or disables hot spot mark (marking the spot of highest temperature).

MENU ITEM	SYMBOL	OPTION	FUNCTION
<b>CHANNEL VIEWING ACTIVATION</b>		OFF / ON 6 palettes	Setting up the display of different palettes for selection.
<b>FUNCTION SETTINGS</b>		<b>Function Settings Menu:</b>	
OSD		OSD / Time / Date	Enables or disables OSD, time, date.
Pitch Scale		OFF / ON	Enables or disables Pitch Scale to view the device inclination angle in the live view.
Brand Logo		OFF / ON	Enables or disables AGM logo on the screen.
USB Connection		USB Flash Drive/ Digital	USB port mode settings.
Image Calib.		Semi-Auto / Manual	Selecting the Flat Field Correction (FFC) mode.
DPC		Axis: X/Y	Correction of dead pixel manually.
Burn Prevention		OFF / ON	Enables or disables the Burn Prevention function.
<b>GENERAL SETTINGS</b>		<b>General Settings Menu:</b>	
Language		26 Languages	Choice of interface language.
Time		12 / 24 hour	Time setting.
Date		Month/Day/Year	Date setting.
Unit		yd / m	Sets the distance unit.
Auto Power Off		OFF / 15 min / 30 min / 45 min	Setting the automatic shutdown time.
Reboot		---	Reset the basic settings: Brightness, Contrast, PIP, etc.
Restore Factory Settings		---	Restoring the default device settings, erase zeroing settings and all internal storage content.
Diagnostic Log		OFF / ON	Using for recording device status and troubleshooting.
Version		---	Firmware version, serial number and free space of built-in storage.

## 2.2.2 BRIGHTNESS ADJUSTMENT







1. Press the MENU button  in live view interface to call the Main Menu.
2. Press  and  buttons to select the  Brightness menu item and press the MENU button  to confirm.
3. Press  and  buttons to adjust the brightness. You can select one of ten levels of the brightness to adjust the image lighter or darker.
4. Press the MENU button  to exit brightness adjustment.

## 2.2.3 CONTRAST ADJUSTMENT

1. Press the MENU button  in live view interface to call the Main Menu, then select the  Contrast menu item and press the MENU button  to confirm.
2. Press  and  buttons to adjust the image contrast. You can select one of ten levels of the contrast.
3. Press the MENU button  to exit contrast adjustment.





## 2.2.4 SHARPNESS SETTING

This function allows you to adjust the sharpness of the thermal image.

1. Press the MENU button  in live view interface to call the Main Menu, then select the  Sharpness menu item and press the MENU button  to confirm.
2. Press  or  button to adjust the image sharpness. You can select one of five levels of the sharpness.
3. Press the MENU button  to exit sharpness adjustment.

## 2.2.5 ZOOM PRO



When you turn on Zoom Pro function, the details of zoomed image will be enhanced.

1. Press the MENU button  in live view interface to call the Main Menu, then select the  Zoom Pro menu item and press the MENU button  to enable or disable Zoom Pro mode.
2. Rotate the wheel to select other item or hold the MENU button  to exit a menu.
4. Hold the MENU button  to exit.

### NOTE:









- If the PIP function is enabled, Zoom Pro is only enabled in the PIP view.
- Zoom Pro cannot be enabled when device battery is low.

## 2.2.6 ADVANCED SETTINGS MENU

Press the MENU button  in the view interface to call the Main Menu. Select the  Advanced Settings menu and press the MENU button  to confirm. The Advanced Settings menu contains all the necessary parameters to fully configure the device.

## 2.2.7 ZEROING PROFILES

The user can customize and save five profiles with different reticle settings. In each profile, you can configure up to five types of reticle, firing distances and reticle corrections.

1. Enter the  **Advanced Settings** menu.
2. Press  or  button to select  **Zeroing Profiles** menu item and press the MENU button  to confirm.
3. Press  or  button to switch the zeroing profile.
4. Press the MENU button  to exit Zeroing Profile setting.

The right top of the image displays the reticle information. For example, A1-100m means you are using the Zeroing No. 1 in the Profile A, and the set range is 100 m.



















**NOTE:**

There are 5 zeroing profiles in total, and you can configure 5 reticles, zeroing distances and corrections in each zeroing profile.

### 2.2.8 ZEROING







You can select a reticle in the current zeroing profile, and set parameters such as reticle type, color, and boresight correction (coordinates) for the reticle.

Select a zeroing profile initially (refer to 2.2.7).

1. Enter the  **Advanced Settings** menu.
2. Press  or  button to select  **Zeroing** menu item and press the MENU button  to enter the zeroing setting interface.
3. Set zeroing number (from 1 to 5).
  - 1) Press  or  to select  **Zeroing** and press the MENU button  to confirm.
  - 2) Press  or  button to select OFF (reticle is disabled) or zeroing number you want to correct and press the MENU button  to confirm.
4. Set reticle type (for parameters of all built-in reticles, see part 5.2).
  - 1) In the zeroing setting interface press  or  button to select  **Type** submenu and press the MENU button  to confirm.
  - 2) Press  or  button to select a reticle type and press the MENU button  to confirm.







**NOTE:**

The scale intervals of the Reticle 4 and Reticle 7 change synchronously under the current digital zoom.

5. Set reticle color.
  - 1) In the zeroing setting interface press  or  button to select  **Reticle Color** submenu and press the MENU button  to confirm.
  - 2) Press  or  button to select black, white, red or green color of reticle and press the MENU button  to confirm.

**NOTE:**

In Black Hot mode and White Hot mode, if you set the reticle color as white or black, the reticle colors can be automatically inverted depends on thermal image around the reticle.

6. Set reticle center color.
  - 1) In the zeroing setting interface press  or  button to select  **Reticle Center Color** submenu and press the MENU button  to confirm.
  - 2) Press  or  button to select black, white, red or green color of reticle center and press the MENU button  to confirm.

- (Optional) Repeat 3 to 6 to set type and color for other reticles in this profile.
- Hold the MENU button  to save and exit.

## 2.2.9 BORESIGHT CORRECTION

Like any daytime rifle scope or red dot, sighting in is both similar, and simplified. The RattlerV3 comes with a one-shot zeroing system, which makes initial sighting in quick and painless.

Set the target to the selected zeroing distance. We recommend 50-100 yards initially. Select a zeroing profile (refer to 2.2.7). You can use different zeroing profiles if you want to use the optic on a different rifles.

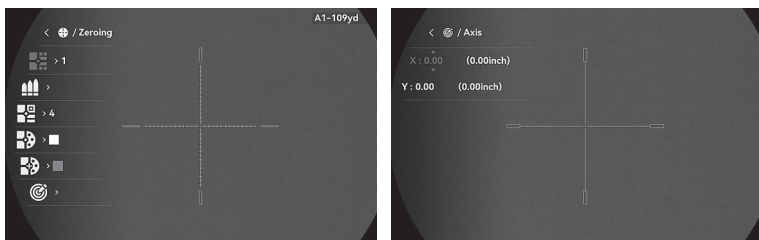

































FIGURE 2-7. BORESIGHTING

Align the reticle with the center of the target and shoot. If the point of impact does not coincide with the aiming point, correct the reticle.

- Enter the  **Advanced Settings** menu.
- Press  or  button to select  **Zeroing** menu item and press the MENU button  to enter the zeroing setting interface.
- Press  or  button to select  **Zeroing** and press the MENU button  to confirm. Press  or  button to select zeroing number you want to correct and press the MENU button  to confirm.
- Press  or  button to select  **Bullet** and press the MENU button  to set the bullet name for your reticle profiles. Press the MENU button  to select the character to edit, and press  or  button to change the character. After you finish to entering the bullet name, hold the MENU button  to exit.
- Press  or  button to select  **Correction** and press the MENU button  to enter the boresight correction interface.

Set the distance to the target:

- 1) In the boresight correction interface press  or  button to select  **Distance** and press the MENU button  to confirm.
- 2) Press the MENU button  to select the digit you want to change (color of selected digit will be changed to the red).
- 3) Press  or  button to change the number and press the MENU button  to confirm.

(Optional) Set the magnification:





- 1) In the boresight correction interface press  or  button to select  **Zoom** option and press the MENU button  to confirm.

- 2) Press  or  button to enlarge the image until the target positions is clear enough. Press the MENU button  to confirm.

**NOTE:**

We'd suggest zeroing in at 1x, or your true optical base magnification, or 2x zoom (double your optical magnification) as these options are less pixelated and should provide for easier adjustments.

(Optional) Activate Freeze Screen function:

- 1) In the boresight correction interface press  or  button to select  Freeze Screen option, and
- 2) Press the MENU button  to enable the Freeze Screen function.



**NOTE:**

When enabling the Freeze Screen function, you can adjust the position of the cursor on a frozen image. This feature helps prevent image flutter and eliminates the need to hold the rifle scope steady in order to make your windage and elevation adjustments on screen.

Set the boresight correction:

- 1) In the boresight correction interface press  or  button to select  X/Y Axis and press the MENU button  to confirm.

Two crosshairs are displayed on the screen. The big one is reticle crosshair, and the small one is reference crosshair. Reference crosshair will appear in the centre of the display. Initially, the centers of both crosshairs are aligned. Zero the scope by moving the reticle on the screen.

- 2) Aim the reticle at the center of target.
- 3) Press the MENU button  to select X or Y axis.
- 4) Press  or  button to move reticle left and right (if X axis is selected) or to move reticle up and down (if Y axis is selected).

Holding the reference small crosshair at the aiming point (center of the target) and move the reticle until it is aligned with the point of impact. The coordinates show the current position of the reticle. It also displays the distance by which the point of impact will move, taking into account the set distance to the target.

6. Hold the MENU button  return to the previous menu.
7. (Optional) Repeat 3 to 5 to set the position for other reticles in this profile. You can place up to five zeroes at different distances within the same profile (useful for certain calibers with highly fluctuating trajectories between 50 and 250 yards/meters).

**TABLE 2-4. BORESIGHT CORRECTION**

ADJUSTMENT VALUE	RETICLE OFFSET	BORESIGHT INCREMENT
1 click	1 pixel	0.35 MOA / 0.1 mil 1 cm at 100 m distance / 0.4 in at 100 yd distance

8. Hold the MENU button  to exit Zeroing menu. The window "Save the parameters?" will appear.

- **OK**: Save the settings and exit.
- **CANCEL**: Exit without saving the settings.





You can also quickly zero your scope using the **AGM Connect** app.

Install the application on your phone and connect your thermal device via WiFi hotspot as described in Chapter 2.3.

1. Run the application.
2. Select your device in the application menu.
2. Select **Zero** in the **Device Info** section.
3. The zeroing interface will appear on the screen of your smartphone. Carry out the procedures in the same way as described above in Paragraph 2.2.9.







## 2.2.11 ALBUMS

Captured images and recorded videos are automatically stored in the device, and you can view the files in local albums.



1. Enter the  **Advanced Settings** menu.
2. Press  or  button to select  **Albums** menu item and press the MENU button  to confirm.

### NOTE:

The albums are automatically created and named by year + month. The local pictures and videos of a certain month are stored in the corresponding album. For example, the pictures and videos of May in 2025 are saved in the album named "202505".

3. Press  or  button to select the album, and press the MENU button  to enter it.
4. Press  or  button to select a file to view.
5. Press the MENU button  to view the selected file and relevant information.

### NOTE:









Files are arranged in chronological order, with the most recent at the top. If you fails to find the most recently taken snapshots or videos, please check the time and date settings of your device. When you are viewing files, you can switch to other files by pressing  or  button.

When you are viewing videos, you can press the MENU button  to play or stop the video.

For deleting an album or a file, you can press  button to call the dialogue box, and delete the album or file according to the prompt.

## 2.2.12 RETICLE MODE

You can select a reticle mode according to your preference and different situations.

1. Enter the  **Advanced Settings** menu.
2. Press  or  button to select  **Reticle Mode** and press the MENU button  to open the options.
3. Press  or  button to select **Central Reticle** or **Fixed Reticle** and press the MENU button  to confirm.

**Fixed Reticle:** This mode centers around the reticle when switching the digital zoom ratio, with the reticle position unchanged.

**Central Reticle:** This mode centers around the reticle when switching the digital zoom ratio, with the reticle and zoomed image moved to the center of the display.









3. Hold the MENU button  to confirm the selection and exit.

**NOTE:**

- The actual zoom ratio returns to the minimum value when switching the reticle mode.
- The zoom ratio may vary according to different models. Please take the actual product for reference.









### 2.2.13 PRERECORD VIDEO

After enabling the Shot Activated Recording (SAR) function, the device will automatically start recording 5, 10, or 15 seconds before and after the recoil-activation.

1. Enter the  Advanced Settings menu.
2. Press  or  to select  Prerecord and press the MENU button  to open the options.
3. Press  or  button to select OFF (disabled SAR) or 5s, 10s, 15s recording time and press the MENU button  to confirm the selection and exit.









### 2.2.14 IMAGE TONE SETTING

This function allows you to change the tone of thermal image to warm or cold.

1. Enter the  Advanced Settings menu.
2. Press  or  button to select  Tone menu item and press the MENU button  to confirm.
3. Press  or  button to select Warm or Cold tone.
4. Press the MENU button  to exit.

### 2.2.15 SCENE MODE

You can select proper Scene Mode according to environment temperature to improve the display effect.















1. Enter the  Advanced Settings menu.
2. Press  or  button to select  Scene Mode menu item and press the MENU button  to confirm.
3. Press  or  button to switch scene mode:
  - General mode:** improves an image so that the object edge is more distinct.
  - Compressed mode:** is more suitable for hunting environment because of the highlight function of small objects.
4. Press the MENU button  to confirm and exit.

### 2.2.16 DISTANCE MEASUREMENT

**NOTE:**

When measuring the distance, keep your hand and the position steady. Otherwise, the accuracy may be affected.

The device can measure the distance between the target and the observer's position.

1. Enter the  **Advanced Settings** menu.
2. Press  or  button to select  **Measure** menu item and press the MENU button  to enter the distance measurement mode.
3. Press  button to enter the target setting interface.
  - 1) Press  or  to select the target from Wolf, Bear, Deer, and Custom.
  - 2) Press the MENU button  to set the target height. Press  or  buttons to change the number. Each target height preset can be modified from 0.1 to 9.9 m. Press the MENU button  to confirm.
  - 3) Hold the MENU button  to exit target setting.
4. Align the center of the top mark with the top edge of the target. Press the MENU button . The top mark blinks and then changes to the bottom mark.
5. Align the center of the bottom mark with the bottom edge of the target. Press the MENU button . The bottom mark blinks and then disappears.
6. The right top of the image displays the distance measurement result and the height of the target.

#### NOTE:







Go to distance measurement interface, and press  button to view the result of the previous measuring target.



FIGURE 2-8. DISTANCE MEASUREMENT

## 2.2.17 NETWORK CONFIGURATION

Connect your phone to the WiFi hotspot of the rifle scope, you can configure the parameters and realize functions of the device.

1. Enter the  **Advanced Settings** menu.
2. Press  or  button to select  **Network** menu item and press the MENU button  to enable or disable WiFi hotspot.
3. Hold the MENU button  to exit.







Open the AGM Connect APP and connect your phone with the device (refer to Section 2.3). You can view the interface of rifle scope on your phone.



#### NOTE:

When the power is less than 15%, the WiFi hotspot function will be turned off automatically.

## 2.2.18 DISPLAY INTERFACE SHAPE

You can switch between the Circular and Rectangular display interface shape.

1. Enter the  Advanced Settings menu.
2. Press  or  button to select  Display Interface Shape menu item and press the MENU button  to confirm.
3. Press  or  button to select Circular or Rectangular display interface shape.
4. The window “This operation requires restarting the device, continue?” will appear.
  - **OK:** Device will restart and display interface shape will change.
  - **CANCEL:** Exit without changing the settings.

Press  or  button to select an option, and then press the MENU button  to confirm.

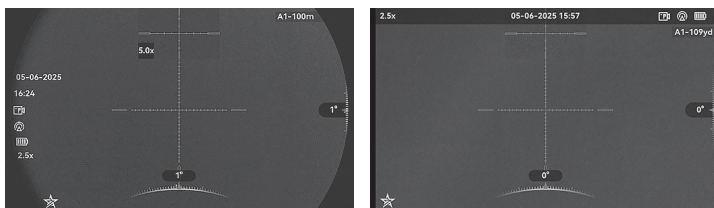









FIGURE 2-9. DISPLAY INTERFACE SHAPE

## 2.2.19 AUTO SCREEN OFF

Auto screen off function darkens the screen to save energy and increase battery time. However, the device stays on and you can view the live view on AGM Connect app when connecting the device to the app.

1. Enter the  Advanced Settings menu.
2. Press  or  button to select  Auto Screen Off menu item. Press the MENU button  to enable or disable Auto Screen Off function.
3. Press  or  to select other menu item or hold the MENU button  to exit.

You can use one of the following methods to enter the standby mode when the display is turned on:









- Tilt the device downwards more than 70°.
- Rotate the device horizontally more than 45°.

You can do one of the following methods to wake up the device when the display is turned off:

- Tilt the device downwards from 0° to 60° or upwards .
- Rotate the device horizontally from 0° to 45°.
- Press  to wake up the device.









## 2.2.20 AUDIO RECORDING SETTING

The Audio function allows you to record sound along with video. If there is too much noise when recording, this function can be disabled.

1. Enter the  **Advanced Settings** menu.
2. Press  or  button to select  **Audio** menu item, and press the MENU button  to enable or disable audio recording.
3. Press  or  to select other menu item or hold the MENU button  to exit.

### 2.2.21 HOT TRACKING









The device can detect the highest temperature spot in the scene and mark it on display.

1. Enter the  **Advanced Settings** menu.
2. Press  or  button to select  **Hot Tracking** menu item and press the MENU button  to enable/disable hot spot mark (marking the spot of highest temperature).
3. Press  or  to select other menu item or hold the MENU button  to exit.

When the hot spot mark is enabled, the green cross mark  displays in the spot of the highest temperature. When the scene changes, the green mark moves.

### 2.2.22 CHANNEL VIEWING ACTIVATION

You can select different palettes to display the same scene in different effects. In the live view mode, press the MODE button  to select a mode (image palette).

1. Enter the  **Advanced Settings** menu.
2. Press  or  button to select  **Custom Palettes** menu, and press the MENU button  to open the options.
3. Press  or  button to select the palette required, and press the MENU button  to enable or disable it.













#### **NOTE:**

At least one palette should be enabled.

4. Hold the MENU button  to exit.













### 2.2.23 ON-SCREEN DISPLAY (OSD)

You can choose which OSD information to display in the live view user interface. Options include, WiFi hotspot activation, current magnification, memory storage status, battery indicator status, time and date. These will appear at the top of the display interface when activated.

1. Enter the  **Advanced Settings** menu.
2. Press  or  button to select  **Function Settings** menu and press the MENU button  to confirm.
3. Press  or  button to select  **OSD** submenu and press the MENU button  to enter.
4. Press  or  button to select the **OSD, Time or Date**. Press the MENU button  to display or hide the necessary information.
5. Hold the MENU button  to exit.













## 2.2.24 PITCH SCALE

You can enable pitch scale to view the device inclination angle in the live view.

1. Enter the  **Advanced Settings** menu.
2. Press  or  button to select  **Function Settings** menu and press the MENU button  to confirm.
3. Press  or  button to select  **Pitch Scale** and press the MENU button  to turn the on-screen pitch scale on or off.
4. Press  or  to select other menu item or hold the MENU button  to exit.













## 2.2.25 BRAND LOGO

You can display the AGM logo in the lower left corner of the screen.

1. Enter the  **Advanced Settings** menu.
2. Press  or  button to select  **Function Settings** menu and press the MENU button  to confirm.
3. Press  or  button to select  **Brand Logo** menu item. Press the MENU button  to enable/disable logo.
4. Press  or  button to select other item or hold the MENU button  to exit.

## 2.2.26 USB CONNECTION

The USB port can be used to transfer data to a PC, charge the installed batteries, or casting screen to PC by UVC protocol-based client software or player. You can view the device screen image on the monitor to get a better and clearer image, more convenient to checking the details.















1. Enter the  **Advanced Settings** menu.
2. Press  or  button to select  **Function Settings** menu and press the MENU button  to confirm.
3. Press  or  button to select  **USB Connection** submenu and press the MENU button  to enter the configuration interface.
4. Press  or  button to select **USB Flash Drive** for transfer data or charge the battery, or **Digital** to casting screen to PC.
5. Press the MENU button  to confirm and exit.

## 2.2.27 IMAGE CALIBRATION

The image calibration function performs what is known as the Flat Field Correction (FFC). This is required of all thermal devices. This can correct for non-uniformity of the display.

RattlerV3 uses shutterless technology. It is based on continuous study of different grey backgrounds, and it is a dynamic correction process that does not lead to loss of image quality. This eliminates the need for periodic calibration pauses, ensuring you never miss a critical moment in the field.















You can also go into the menu and switch to **Semi-Auto** or **Manual** correction mode. During correction an internal shutter will be lowered in front of the thermal detector. A "click" sound will be heard, and the image is momentarily interrupted for a split second. After this quick process the detector will be re-calibrated, and the image becomes more accurate.

1. Enter the  **Advanced Settings** menu.
2. Press  or  button to select  **Function Settings** menu and press the MENU button  to confirm.
3. Press  or  button to select  **Image Calib.** submenu and press the MENU button  to enter.
4. Press  or  button to switch the FFC mode.  
**Semi-Auto:** Hold the MODE button  in live view to correct the non-uniformity of display.  
**Manual:** Cover the lens cap, then hold the MODE button  in live view to correct the non-uniformity of display.
5. Hold the MENU button  to exit.

## 2.2.28 DEFECTIVE PIXELS CORRECTION













The Defective Pixel Correction (DPC) can help users repair the occasional deactivated pixel within the display. This is fairly common in thermal optics, which is why so many of these optics come equipped with a DPC feature. 1-3 dead pixels are usually easily repaired by the user. Anything over 3 that cannot be repaired, will open the unit up to an approved warranty repair by AGM at their facility.

Before you start switch the palette to White Hot mode.

1. Enter the  **Advanced Settings** menu.
2. Press  or  button to select  **Function Settings** menu and press the MENU button  to confirm.
3. Press  or  button to select  **DPC** submenu and press the MENU button  to enter.
4. Press the MENU button  to select the X or Y axis.
5. Press  or  button to set the coordinates until the cursor reaches the dead pixel. The screen will display a magnified area around the selected pixel.
6. Press the MENU button  twice to correct the dead pixel.
7. (Optional) Repeat 4 to 6 to correct the position for other dead pixels.
8. Hold the MENU button  to exit.













## 2.2.29 BURN PREVENTION

This function can prevent damage to the thermal sensor from the sun or other high temperature bright light sources. When enabling this function, the shield will close until the environment turns to normal. This feature may be useful to help protect sensitive displays during extreme summer temperatures. AGM recommends all units be stored in room temperature whenever possible, as long periods of storage in extreme heat (such as inside a vehicle) may lead to issues with the display materials.













1. Enter the  **Advanced Settings** menu.
2. Press  or  button to select  **Function Settings** menu and press the MENU button  to confirm.
3. Press  or  button to select  **Burn Prevention** submenu and press the MENU button  to enable or disable the Burn Prevention function.
4. Press  or  button to select other item or hold the MENU button  to exit.

### 2.2.30 LANGUAGE SETTING













You can select different languages of user interface.

1. Enter the  **Advanced Settings** menu.
2. Press  or  button to select  **General Settings** and press the MENU button  to confirm.
3. Press  or  button to select  **Language** submenu and press the MENU button  to enter.
4. Press  or  button to select the language as required and press the MENU button  to confirm.
5. Hold the MENU button  to exit.

### 2.2.31 TIME SETTING













1. Enter the  **Advanced Settings** menu.
2. Press  or  button to select  **General Settings** and press the MENU button  to confirm.
3. Press  or  button to select  **Time** submenu and press the MENU button  to enter the configuration interface.
4. Press the MENU button  to select the hour, minute, second to be synchronized and press  or  button to change the number.
5. Hold the MENU button  to exit.

### 2.2.32 DATE SETTING

1. Enter the  **Advanced Settings** menu.
2. Press  or  button to select  **General Settings** and press the MENU button  to confirm.
3. Press  or  button to select  **Date** submenu and press the MENU button  to enter the configuration interface.
4. Press the MENU button  to select the month, day or year to be synchronized and press  or  button to change the number.
5. Hold the MENU button  to exit.

### 2.2.33 UNIT SETTING







You can set the unit (yards or meters) of measurement for distance.

1. Enter the  **Advanced Settings** menu.
2. Press  or  button to select  **General Settings** and press the MENU button  to confirm.
3. Press  or  button to select  **Unit** submenu and press the MENU button  to enter the configuration interface.
4. Press  or  button to select Yard or Meter.
5. Hold the MENU button  to exit a menu.

### 2.2.34 AUTO POWER OFF









You can set the time for the automatic shutdown of the device as required.

1. Enter the  **Advanced Settings** menu.
2. Press  or  button to select  **General Settings** and press the MENU button  to confirm.

3. Press  or  button to select  **Auto Power Off** submenu and press the MENU button  to enter the configuration interface.
4. Press  or  button to select OFF, 15 min, 30 min or 45 min.
5. Press the MENU button  to exit.









### 2.2.35 REBOOT

You can reset all the basic settings (Brightness, Contrast, Sharpness, PIP, etc.) to default values.

1. Enter the  **Advanced Settings** menu.
2. Press  or  button to select  **General Settings** and press the MENU button  to confirm.
3. Press  or  button to select  **Reboot** and press the MENU button . The window “Reset the basic settings” will appear.
  - OK: Restore the basic settings to defaults.
  - CANCEL: Exit without changing the settings.











### 2.2.36 RESTORE FACTORY SETTINGS

You can reset all device settings and delete all contents of the built-in storage.

1. Enter the  **Advanced Settings** menu.
2. Press  or  button to select  **General Settings** and press the MENU button  to confirm.
3. Press  or  button to select  **Restore Factory Settings** and press the MENU button . The window “Erase all content and settings” will appear.
  - OK: Erase all content and restore all settings to defaults.
  - CANCEL: Exit without changing the settings.









### 2.2.37 DIAGNOSTIC LOG

Diagnostic Log using for recording device status and troubleshooting. You can find the log files in the *log* folder in the device memory and send them to the support service if necessary (see paragraph 2.1.15 about exporting files).

1. Enter the  **Advanced Settings** menu.
2. Press  or  button to select  **General Settings** and press the MENU button  to confirm.
3. Press  or  button to select  **Diagnostic Log** and press the MENU button . A confirmation window will appear.
4. Select OK and press the MENU button  to start recording the log.

### 2.2.38 VERSION

You can view the device information such as firmware version, serial number and free space of built-in storage.

1. Enter the  **Advanced Settings** menu.
2. Press  or  button to select  **General Settings** and press the MENU button  to confirm.
3. Press  or  button to select  **Version** item and press the MENU button  to confirm. The firmware version, serial number and memory capacity will be displayed.

## 2.3 CLIENT SOFTWARE INTRODUCTION



Search the AGM Connect software in App Store (iOS System) or Google Play™ (Android System) and install the application on your mobile phone. Turn on the WiFi hotspot on the thermal device and then connect your phone to the hotspot.

- Hotspot Name: Wlan-<Serial No.>

- Hotspot Password: Last 9 digits of Serial Number of your thermal scope.

### NOTE:

The device password is set by user at first activation. If the password was lost or forgotten, it can be reset. To reset a password perform the following steps:  
1. When the thermal device is turned on, hold the MENU button  to activate the Main menu.

2. Select  Restore item in the General Settings menu and press the MENU button  to restore all parameters to default settings.

1. Run the app and connect the phone or tablet with the device.

2. If the device is inactivated, set the password and activate it. If the device is activated, enter the password to add it to the app.

3. When the device is added, the live view can be seen. You can view the interface of the device on the software. User can change such image parameters as brightness, contrast, zoom, palettes directly via phone or tablet as well as record video on phone/tablet memory.

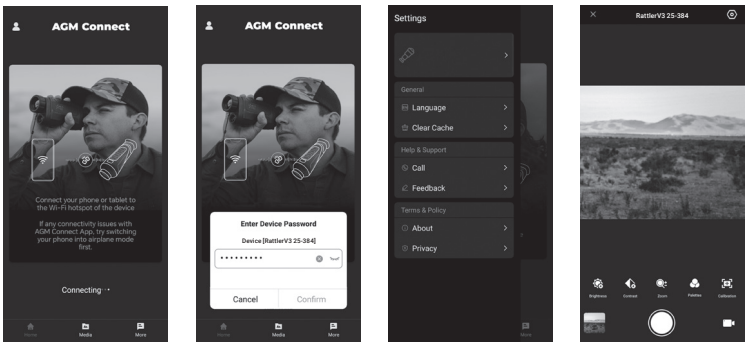

FIGURE 2-10. AGM CONNECT APP

# 3 MAINTENANCE

## 3.1 MAINTENANCE

### 3.1.1 CLEANING PROCEDURES

1. Gently brush off any dirt from the body of the device using a clean, soft cloth.
2. Moisten the cloth with fresh water and gently wipe down the external surfaces (except lenses).
3. Dry any wet surfaces (except lenses) using another dry, clean, soft cloth.
4. Using a lens brush, carefully remove all loose dirt from the lenses.
5. Use a high quality lens wipe to remove dirt or smudges from the lens and display window. Do not use abrasives or solvents to clean the housing, lens, or display window. Clean the glass surfaces using circular movements, starting from the center of the lens and moving out towards the edge.
6. Clean the accessories with a soft brush (or cloth) dampened with soap and water.

### 3.1.2 PREPARING FOR EXTENDED STORAGE

#### **CAUTION:**

Thoroughly dry each item before placing them into the storage case.

To prepare the rifle scope for extended storage:

1. Clean the rifle scope with a damp cloth to remove any dust, dirt or debris.
2. Remove the batteries.
3. Close the lens cap, and place items into their soft carrying case.

### 3.1.3 UPDATING THE DEVICE FIRMWARE

#### **WARNING:**

Please make sure the device is connected to the computer during the entire update process. Otherwise, it may cause unnecessary upgrade failure, firmware damage, etc.

1. Visit [www.agmglobalvision.com/firmware](http://www.agmglobalvision.com/firmware) website. Select your product, download the firmware update package to your PC and unzip it. Follow the detailed instructions on the website.
2. Connect the device to your PC with USB cable.
3. Turn on the device. Make sure the WiFi hotspot function is disabled.
4. Open the detected disk (USB drive) in file manager program. Copy the unzipped `digicap.dav` file and paste it to the root directory of the device.

5. Turn off the device completely, then power it back on. After awhile, the firmware update process will start automatically. During the update, the screen will display the inscription “Upgrading...”. The update process will be completed when the inscription “Upgrading...” goes out.

6. Turn off the device and disconnect it from your PC.

You can also enjoy automatic update function in AGM Connect App (see section 2.3 for details).

1. Start the AGM Connect App and tap the Settings icon in the left top corner.

2. Tap your device in the device list. The information about your device will be shown.

3. Tap **Checking for Upgrade** to detect and download the latest FW version.

## 3.2 TROUBLESHOOTING

Table 3-1 lists the most common malfunctions that may occur with your equipment. This table does not list all the malfunctions that may occur with your device. If the equipment malfunction is not corrected by the suggested actions, or a problem occurs that is not listed in this table, please contact AGM Global Vision’s Customer Support center or your retailer.

TABLE 3-1. TROUBLESHOOTING

MALFUNCTION	CORRECTIVE ACTION
The scope fails to activate.	<ol style="list-style-type: none"> <li>1. Battery are missing or improperly installed. Insert batteries or install correctly.</li> <li>2. Battery are dead. Replace or charge the battery.</li> <li>3. Battery, surfaces or contacts are dirty or corroded. Clean the contacts.</li> </ol>
The scope shut off sometimes after shot.	<ol style="list-style-type: none"> <li>1. Low battery level. Check the remaining capacity of the battery, which may be low on power to maintain performance. Replace or charge the battery.</li> </ol>
The image is not clear.	Perform the sight adjustment referring to section 2.1.
WiFi is not found.	Examine whether the WiFi function is turned on. If not, turn on the WiFi hotspot in the menu.
Capturing or recording fails.	<ol style="list-style-type: none"> <li>1. The device is connected to your PC and has disabled the capturing and recording. Disconnect the device.</li> <li>2. The storage space is full. Delete old files.</li> <li>3. The device is in a low-battery condition. Replace the battery.</li> </ol>
The PC cannot identify the scope.	<ol style="list-style-type: none"> <li>1. The device is connected to your PC with standard USB cable. If you use other USB cables, make sure the cable length is no longer than 1 m.</li> <li>2. The WiFi function is turned on. If so, turn off the WiFi hotspot in the menu.</li> </ol>

## 4 WARRANTY INFORMATION

### 4.1 WARRANTY INFORMATION AND REGISTRATION

The below description of AGM Global Vision warranty terms and conditions refer specifically to AGM branded products purchased within the United States. Customers purchasing AGM products outside the United States can obtain specific information about their product's warranty term on the [www.agmglobalvision.eu](http://www.agmglobalvision.eu) website.

#### 4.1.1 WARRANTY INFORMATION

This product is guaranteed to be free from manufacturing defects in material and workmanship under normal use for a period of five (5) years from the date of purchase. In the event that a defect covered by the warranty below occurs during the applicable period stated above, AGM Global Vision, at its discretion, will either repair or replace the product; such action on the part of AGM Global Vision shall be the full extent of AGM Global Vision's liability, and the Customer's sole and exclusive reparation. This warranty does not cover a product if it has been (a) used in ways other than its normal and customary manner; (b) subjected to misuse; (c) subjected to alterations, modifications or repairs by the Customer or by any party other than AGM Global Vision without prior written consent of AGM Global Vision; (d) is the result of a special order or categorized as "close-out" merchandise or merchandise sold "as-is" by either AGM Global Vision or the AGM Global Vision dealer; or (e) merchandise that has been discontinued by the manufacturer and either parts or replacement units are not available due to reasons beyond the control of AGM Global Vision. AGM Global Vision shall not be responsible for any defects or damage that in AGM Global Vision's view are a result from the mishandling, abuse, misuse, improper storage or improper operation of the device, including use in conjunction with equipment that is electrically or mechanically incompatible with, or of inferior quality to, the product, as well as failure to maintain the environmental conditions specified by the manufacturer. This warranty is extended only to the original purchaser. Any breach of this warranty shall be enforced unless the customer notifies AGM Global Vision at the address noted below within the applicable warranty period.

The customer understands and agrees that except for the foregoing warranty, no other warranties written or oral, statutory, expressed or implied, including any implied warranty of merchantability or fitness for a particular purpose, shall apply to the product. All such implied warranties are hereby and expressly disclaimed.

#### 4.1.2 LIMITATION OF LIABILITY

AGM Global Vision will not be liable for any claims, actions, suits, proceedings, costs, expenses, damages, or liabilities arising out of the use of this product. Operation and use of the product are the sole responsibility of the Customer. AGM Global Vision's sole undertaking is limited to providing the products and services outlined herein in accordance with the terms and conditions of

this Agreement. The provision of products sold and services performed by AGM Global Vision to the Customer shall not be interpreted, construed, or regarded, either expressly or implied, as being for the benefit of or creating any obligation toward any third party of legal entity outside AGM Global Vision and the Customer; AGM Global Vision's obligations under this Agreement extend solely to the Customer. AGM Global Vision's liability hereunder for damages, regardless of the form or action, shall not exceed the fees or other charges paid to AGM Global Vision by the customer or customer's dealer. AGM Global Vision shall not, in any event, be liable for special, indirect, incidental, or consequential damages, including, but not limited to, lost income, lost revenue, or lost profit, whether such damages were foreseeable or not at the time of purchase, and whether or not such damages arise out of a breach of warranty, a breach of agreement, negligence, strict liability, or any other theory of liability.

#### **4.1.3 PRODUCT REGISTRATION**

In order to validate the warranty on your product, the customer must complete and submit AGM Global Vision PRODUCT REGISTRATION FORM on our website ([www.agmglobalvision.com/customer-support](http://www.agmglobalvision.com/customer-support)).

#### **4.1.4 OBTAINING WARRANTY SERVICE**

To obtain warranty service on your unit, the End-user (Customer) must notify the AGM Global Vision service department via e-mail. Send any requests to [support@agmglobalvision.com](mailto:support@agmglobalvision.com) to receive a Return Merchandise Authorization number (RMA). When returning any device, please take the product to your retailer, or send the product, postage paid and with a copy of your sales receipt, to AGM Global Vision's service center at the address listed above. All merchandise must be fully insured with the correct postage; AGM Global Vision will not be responsible for improper postage or merchandise that becomes lost or damaged during shipment. When sending product back, please clearly write the RMA# on the outside of the shipping box. Please include a letter that indicates your RMA#, the Customer's Name, a Return Address, reason for the return, contact information (valid telephone numbers and/or an e-mail address), and proof of purchase that will help us to establish the valid start date of the warranty. Product merchandise returns that do not have an RMA# listed may be refused, or a significant delay in processing may occur. Estimated Warranty service time is 10-20 business days. The End-user/Customer is responsible for postage to AGM Global Vision for warranty service. AGM Global Vision will cover return postage/shipping after warranty repair to the End-user/Customer only if the product is covered by the aforementioned warranty. AGM Global Vision will return the product after warranty service by domestic UPS Ground service and/or domestic mail. Should any other requested, required, or international shipping methods be necessary, the postage/shipping fee will be the responsibility of the End-user/Customer.

#### **AGM Global Vision, LLC**

2407 E Interstate 30, Suite 100

Grand Prairie, TX 75050

Tel. 928.333.4300

[support@agmglobalvision.com](mailto:support@agmglobalvision.com)

[www.agmglobalvision.com](http://www.agmglobalvision.com)

# 5 SPECIFICATIONS

## 5.1 SPECIFICATIONS

RATTLER V3 25-384	
Image Sensor	12µm VOx Uncooled Focal Plane Array
Resolution	384 × 288
Refresh Rate	50 fps
NETD	Less than 15 mK (@25°C), F#=1.0
Detection Range (6' object)	1,770 m
Lens System	25 mm, F /1.0
Magnification	2.5× – 20×
Digital Zoom	1×, 2×, 4×, 8×
Field of View (H×V)	10.5° × 6.3°
Eye Relief	45 mm
Exit Pupil	6 mm
Diopter Adjustment	-4D to +3D
Minimum Focusing Distance	15 m
Display	1920×1080, 0.49 inch, OLED
Picture-in-Picture Mode (PIP)	Yes
Hot Tracking	Yes
Palettes	Black Hot, White Hot, Red Hot, Fusion, Red Monochrome, Green Monochrome
Scene Modes	General, Compressed
Brightness Adjustment	Yes
Contrast Adjustment	Yes
Sharpness Adjustment	Yes
Tone Adjustment	Cold, Warm
Image Boost 2.0	Yes

Zoom Pro	Yes
Shutterless Technology	Yes
Flat Field Correction (FFC)	Semi-Auto, Manual,
Defective Pixel Correction (DPC)	Yes
Burn Prevention	Yes
Distance Measurement	Yes (Stadiametric)
Reticle	10 types, 4 colors, on/off
Boresight Adjustment	Digital Controlled
Zeroing Profiles	5
Freeze Zeroing	Yes
WiFi Hotspot	Yes
Video Recording	Yes (1920×1080)
Image Capture	Yes (1920×1080)
Audio Recording	Yes
Shot Activated Recording (SAR)	Yes
Storage	Built-in EMMC (64 GB)
Video Output	UVC screen casting (via USB Type-C)
Local Album	Yes
Standby Mode	Yes
Battery Type	One replaceable rechargeable NE-4400 Li-Ion battery (two NE-4400 batteries included)
Battery Life (WiFi hotspot off)	Over 7 h (25 °C, WiFi hotspot off)
External Power	Supports external 5 VDC/2 A power supply via Type-C interface
Working Temperature	-30°C to 55°C (-22°F to 131°F)
Protection Level	IP67
Max/ Recoil	1,000 g / 0.4 ms
Dimensions (w/o mount)	219 × 68 × 67 mm (8.6 × 2.68 × 2.64 in)
Weight (w/o mount and battery)	0.49 kg (1.1 lb)

All data subject to change without notice.

## 5.2 RETICLE PARAMETERS

IMAGE	ITEM	MOA	CM @100M	IN @100YD
<b>RETICLE 1</b>				
	A	98.6	287.0	103.3
	B	99.3	289.0	104.0
	C	2.5	7.2	2.6
	D	20.0	58.2	20.9
	E	6.0	17.4	6.2
<b>RETICLE 2</b>				
	A	119.4	347.2	125.0
	B	111.6	324.7	116.9
	C	2.5	7.2	2.6
<b>RETICLE 3</b>				
	A	119.4	347.2	125.0
	B	112.0	325.8	117.3
	C	2.5	7.2	2.6

IMAGE	ITEM	MOA	CM @100 M	IN @100 YD
<b>RETICLE 4</b>				
	A	93.4	271.6	97.8
	B	84.6	246.1	88.6
	C	22.1	64.3	23.2
	D	3.9	11.2	4.0
	E	26.7	77.6	28.0
	F	2.5	7.2	2.6
	G	3.9	11.2	4.0
	H	3.9	11.2	4.0
	I	2.5	7.2	2.6
	J	4.6	13.3	8.7
	K	3.2	9.2	3.3
<b>RETICLE 5</b>				
	A	3.2	9.2	3.3
	B	3.5	10.2	3.7
	C	1.1	3.1	1.1
	D	0.7	2.0	0.7
<b>RETICLE 6</b>				
	A	6.7	19.4	7.0
	B	1.1	3.1	1.1

IMAGE	ITEM	MOA	CM @100M	IN @100YD
<b>RETICLE 7</b>				
	A	129.2	375.8	135.3
	B	108.8	316.6	113.9
	C	23.9	69.4	25.0
	D	2.8	8.2	2.9
	E	3.2	9.2	3.3
	F	2.8	8.2	2.9
	G	4.2	12.3	4.4
	H	3.9	11.2	4.0
	I	5.6	16.3	5.9
	J	8.4	24.5	8.8
	<b>RETICLE 8</b>			
	A	107.1	311.5	112.1
	B	25.6	74.5	26.8
	C	2.5	7.2	2.6
<b>RETICLE 9</b>				
	A	2.8	8.2	2.9
	B	26.0	75.6	27.2
	C	2.5	7.2	2.6
<b>RETICLE 10</b>				
	A	4.9	14.3	5.1

All data subject to change without notice.

**NOTE:**

The scale intervals of the Reticle 4 and Reticle 7 change synchronously under the current digital zoom.





## **AGM Global Vision, LLC**

### **MAIN OFFICE**

2407 E Interstate 30,  
Suite 100

Grand Prairie, TX 75050

USA

Tel. +1.928.333.4300

[info@agmglobalvision.com](mailto:info@agmglobalvision.com)

[www.agmglobalvision.com](http://www.agmglobalvision.com)

### **EUROPEAN OFFICE**

#6 Andrey Lyapchev Blvd

Sofia, P.C. 1756

Bulgaria

Tel. +35.988.560.0326

[info@agmglobalvision.eu](mailto:info@agmglobalvision.eu)

[www.agmglobalvision.eu](http://www.agmglobalvision.eu)

### **DOWNLOAD AGM CONNECT APP:**



Google Play Store



Apple App Store

[AGMglobalvision.com](http://AGMglobalvision.com)