

# UNVG

ULTRALIGHT NIGHT VISION GOGGLES

USER MANUAL

© 2025 AGM Global Vision, LLC. All rights reserved.

This documentation is subject to change without notice.

No parts of this manual, in whole or in part, may be copied, photocopied, translated, or transmitted by any electronic medium or in machine-readable form without the prior written permission of AGM Global Vision, LLC.

If you have questions that are not covered in this manual, or need service, contact AGM Global Vision customer support for additional information prior to returning a product.

**AGM Global Vision, LLC**

2407 E Interstate 30,  
Suite 100  
Grand Prairie, TX 75050  
USA  
Tel. +1.928.333.4300  
info@agmglobalvision.com  
www.agmglobalvision.com

**EXPORT INFORMATION**

Buyer acknowledges that all products supplied by AGM Global Vision, LLC are subject to U.S. export control laws, including, but not limited to, the Export Administration Regulations, the International Traffic in Arms Regulations, the International Economic Emergency Powers Act, and various U.S. embargoes and sanctions. AGM Global Vision products may not be exported, re-exported, or transferred contrary to U.S. export control laws. In particular, AGM Global Vision products may not be exported, re-exported, or transferred to prohibited countries, individuals, organizations, or entities, including but not limited to those individuals and entities listed on the List of Specially Designated Nationals and Blocked Persons administered or maintained by the U.S. Office of Foreign Assets Control (“OFAC”), the various lists maintained by the Bureau of Industry and Security of the Department of Commerce, and the U.S. State Department and Buyer represents and warrants that neither Buyer nor any of its officers, directors, or employees are on such lists. Distribution or resale by Buyer to such countries, individuals, organizations, or entities is expressly prohibited. Buyer has and will maintain a positive process to ensure compliance with this Section.

# LIST OF CONTENTS

TITLE	PAGE
Safety Summary	4
<b>SECTION 1. GENERAL INFORMATION</b>	<b>6</b>
1.1 System Description	6
1.2 Key Features	7
1.3 Standard Components	8
1.4 Optional Equipment	9
<b>SECTION 2. OPERATING INSTRUCTIONS</b>	<b>10</b>
2.1 Installation and Mounting	10
2.2 System Controls	15
2.3 Operating	18
<b>SECTION 3. MAINTENANCE AND TROUBLESHOOTING</b>	<b>20</b>
3.1 Maintenance	20
3.2 Troubleshooting	21
<b>SECTION 4. WARRANTY INFORMATION</b>	<b>23</b>
4.1 Warranty Information and Registration	23
<b>SECTION 5. SPECIFICATIONS</b>	<b>26</b>
5.1 Goggles Specifications	26
5.2 Battery Pack Specifications	27

## SAFETY SUMMARY

- Read and follow all instructions
- Read all warnings
- Only use the attachments/accessories specified by the manufacturer
- All service must be provided by the manufacturer

### **WARNING:**

This product contains natural rubber latex, which may cause potentially fatal allergic reactions! If you are allergic to latex, it is important that you strictly avoid exposure to products that contain it.

### **WARNINGS:**

The intensifier's phosphor screen contains toxic materials. Please note:

- If the intensifier tube breaks, be extremely careful to avoid inhaling the phosphor screen material. DO NOT allow the material to come in contact with your mouth, eyes, or any open wounds on the skin.
- If the phosphor screen material comes in contact with your skin, wash it off immediately with soap and water.
- If you inhale or swallow any phosphor screen material, drink a lot of water, induce vomiting, and seek medical attention as soon as possible.

### **WARNINGS:**

- DO NOT DISASSEMBLE THE DEVICE. Disassembly can cause permanent damage.
- Use of the UNVG in brightly light conditions and in the places with bright light sources such as firelight, headlights, searchlights, etc. can damage the unit's intensifier tubes. Avoid exposing the unit to these types of light sources.
- When operating the device in extremely dark conditions, the light from the unit's IR illuminator will be invisible to the unaided eye. However, the light can be detected by other night vision devices (NVD).
- To reduce the risk of detection by another NVD, avoid prolonged activation of the IR illuminator.
- The IR light is more easily detected by an NVD when used in smoke, fog and rain. Avoid prolonged activation of the unit's IR illuminator in these conditions.

## **CAUTIONS:**

- The UNVG is a precision optical instrument. To prevent damage to the unit, it should always be handled carefully.
- Do not scratch the external lens surfaces or touch them with your fingers.
- To protect the image intensifier, keep the lens cap securely fitted over the objective lens when the device is not in use, or when it is being used in daylight conditions.
- Keep the equipment clean. Protect it from moisture, dramatic temperature drops, and electrical shocks.
- DO NOT force the equipment controls past their stopping points.
- DO NOT leave the equipment activated during breaks in operation.
- DO NOT store the equipment with the batteries installed.
- Thoroughly clean and dry each item before placing them into the storage case.

## **NOTES:**

- Do not test the device in daylight conditions for more than ten (10) minutes, even with the daylight filter/ lens cap on.
- The purpose of the built-in IR illuminator is to provide additional illumination when necessary while viewing scenes at close distances (up to 3 meters).
- The equipment requires some ambient light (moonlight, starlight, etc.) to operate.
- Performance of the device in night-time conditions depends on the level of ambient light in the environment. Please remember the following:
  - The level of ambient light is reduced by the presence of clouds, shade, or objects that block natural light (trees, buildings, etc.).
  - The equipment is less effective when operated in shadows and other darkened areas.
  - The equipment is less effective when operated in rain, fog, sleet, snow, dust or smoke.
  - The equipment will not “see” through dense smoke.

# 1 GENERAL INFORMATION

## 1.1 SYSTEM DESCRIPTION

The AGM UNVG is a dual-channel night vision system. The UNVG uses advanced multi-coated optics and is built to last with a compact composite housing. The device can be outfitted with a Gen 2+ or Gen 3 high-performance image intensifier tube (IIT). The UNVG is also equipped with manual gain control, which adjusts the image brightness, providing the highest possible image quality even in changing light conditions. The independent movement of the tube pods allows for single or dual eye configurations for increased operational flexibility. Each tube automatically turns off when its pod is turned sideways. Operating from a single AA alkaline battery, the UNVG can run up to 15 hours. With an external battery pack (included), the operating time increases to 50 hours. Also equipped with an integral infrared illuminator for reading in the dark. The device can be installing to a either standard dovetail type headset and helmet mount.

UNVG-51 model with a 51° field of view provides a large visual field without needing to move the binoculars.

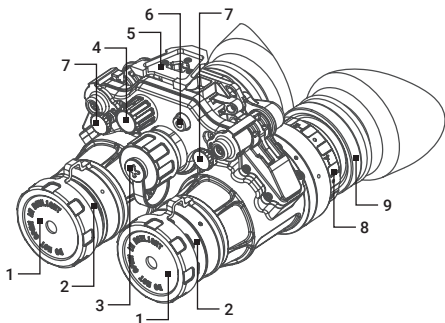

FIGURE 1-1. UNVG SYSTEM DESCRIPTION

TABLE 1-1. UNVG SYSTEM DESCRIPTION

ITEM	DESCRIPTION	ITEM	DESCRIPTION
1	Lens Cap	6	Built-In IR Illuminator
2	Focus Ring	7	Interpupillary Distance Adjustment Fixing Knob
3	Battery Cap	8	Diopter Adjustment Ring
4	Knob Switch	9	Eyepiece
5	Mounting Bracket		

## 1.2 KEY FEATURES

- **Low Power Consumption Design:** Utilizes single AA battery or external battery pack.
- **Auto Off Feature:** Each tube automatically turns off when its pod is turned sideways.
- **Corrosion and Impact-Resistant Housing:** Matte black finish with PEEK+Glass fiber material for longevity.
- **Quick Attachment Design:** Dovetail base support for strong compatibility and durability.
- **PVS-14-style Compatible:** Objective lens and eyepiece lens are compatible with PVS-14 style components and attachments.
- **Independent Pod Movement:** Pods can roll up and down for quick configuration changes.
- **Single/Double Eye Configuration:** Pods independently adjustable for improved operational flexibility.
- **IR Complement Function:** Infrared illuminator for enhanced visibility in total darkness and close quarters environments.
- **Manual Gain Control:** Adjust image intensifier gain for optimal vision preferences.
- **New Simplified IP Stop Design:** Improve IP Stop design allows you to set your pod positions to what is most comfortable for the user.

## 1.3 STANDARD COMPONENTS

The standard components of the UNVG are shown in Figure 1-2 and listed in Table 1-2.

The ITEM column indicates the number used to identify items in Figure 1-2.

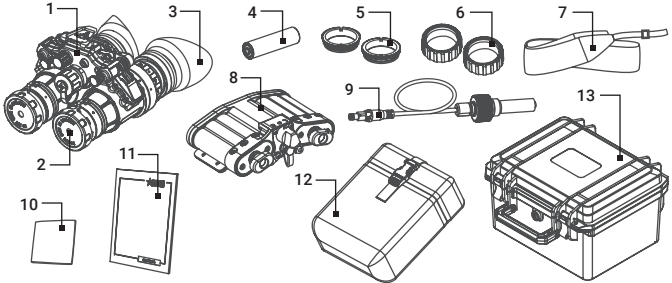

FIGURE 1-2. UNVG STANDARD COMPONENTS

TABLE 1-2. UNVG STANDARD COMPONENTS

ITEM	DESCRIPTION	QUANTITY
1	Night Vision Binocular	1
2	Lens Cap	2
3	Eyecup	2
4	AA Battery	1
5	Demist Shield	2
6	Sacrificial Window	2
7	Neck Strap	1
8	Battery Pack	1
9	Connecting Cable	1
10	Lens Cloth	1
11	User Manual	1
12	Soft Carrying Case	1
13	Hard Case for Storage/Transportation	1

## 1.4 OPTIONAL EQUIPMENT

The optional equipment of the UNVG is shown in Figure 1-3 and listed in Table 1-3.

The ITEM column indicates the number used to identify items in Figure 1-3.

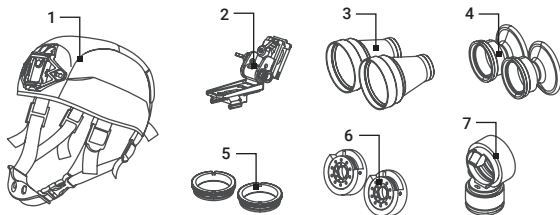

FIGURE 1-3. UNVG OPTIONAL EQUIPMENT

TABLE 1-3. UNVG OPTIONAL EQUIPMENT

ITEM	DESCRIPTION	PART NO.
1	AGM Soft Headgear with Shroud, black	6135SHS1
1	AGM Soft Headgear with Shroud, camouflage	6135SHS5
2	Dovetail Helmet Mount for Shroud	6103DHMS1
3	3X Afocal Magnifier Lens Assembly (1 pc)	61023XA1
4	Shuttered Rubber Eyecup (1 pc)	6114P4S1
5	Amber Filter (2 pcs)	6133AMBF0
6	Adjustable Iris Aperture Diaphragm (2 pcs)	6133AIAD0
7	Compass	NSN: 5855-01-381-6052

## 2 OPERATING INSTRUCTIONS

### 2.1. INSTALLATION AND MOUNTING

#### 2.1.1 BATTERY INSTALLATION

The UNVG operates on a single AA battery. Install the battery as follows:

1. Unscrew the battery cap(A).
2. Insert the AA battery (B), observing the polarity markings (C) as indicated on the battery cap.
3. Screw the battery cap back into place.

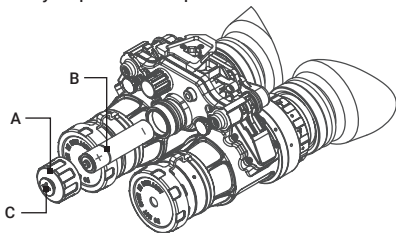

FIGURE 2-1. BATTERY INSTALLATION

#### 2.1.2 INSTALLING BATTERIES INTO THE BATTERY PACK

An additional battery pack can be used to increase the operating time of the UNVG. The battery pack can work with 3V CR1123A Lithium batteries or 1.5V AA batteries.

#### **CAUTION:**

- Before opening the battery compartment cover, make sure the power switch is off.
- Do not operate in wet and rain conditions. Otherwise, it will cause water in the battery compartment and short circuit of the battery.
- If the battery pack is not used for a long time, please take out the batteries to avoid battery leakage.

Install the batteries into the battery pack as follows:

1. Turn the battery compartment cover knob at the top of the battery pack 90° clockwise to unlock the battery cover.
2. Load two AA batteries or one CR123A into each battery compartment (as shown in Figure 2-2). Pay attention to the battery polarity orientation when loading.
3. Reset the battery compartment cover and press it firmly. Turn the battery cover knob 90° counterclockwise to lock the battery cover.

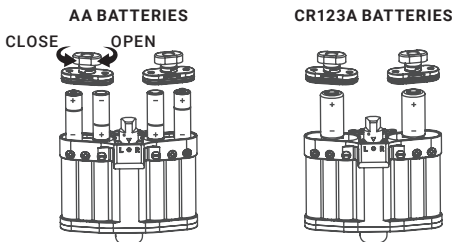

FIGURE 2-2. INSTALLING BATTERIES INTO THE BATTERY PACK

### 2.1.3 CONNECTING THE BATTERY PACK

The battery pack can be used as an external power supply to power the UNVG, and is connected to the night vision device through the air plug and connecting cable. The adapter of connecting cable must be inserted into the UNVG battery compartment. The battery pack can be installed to the helmet with a bracket, and can be quickly removed from the bracket.

#### **CAUTION:**

**Before UNVG connecting, make sure that the battery compartment covers are closed, the UNVG switch is off, and the battery pack switch is off.**

Install the battery pack on the back side of the helmet using battery pack bracket (refer to Fig. 2-3).

1. The battery pack (A) is secured to the bracket (B) using the latch (C). Press the latch to release the battery pack and pull it up to remove it from the bracket.
2. Pieces of “Velcro” fastening tape (D) are secured to the bracket platforms.

3. Attach the bracket to the back side of the helmet using “Velcro” tape.
4. Install the battery pack so that the tab (E) of the bracket fits into the groove (F) on the battery pack body and slide the battery pack until the latch (C) fits into the rectangular hole (G).
5. To remove the battery pack from the bracket, press the latch (C) and slide the battery pack upward as shown in the figure.

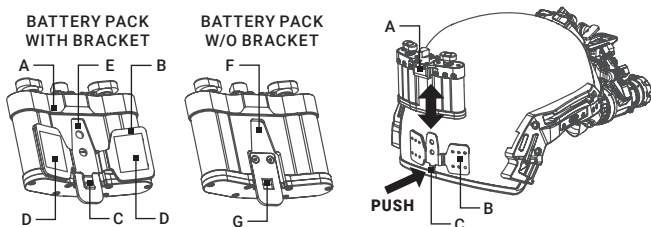

FIGURE 2-3. INSTALLING THE BATTERY PACK

Connect the battery pack as follows (refer to Fig. 2-4).

1. Unscrew and remove the UNVG battery cap.
2. Insert the cable adapter (A) into the UNVG battery compartment (B) and screw it until it stops.
3. Install the UNVG to the helmet (see 2.1.6).
4. Connect the air plug (C) of the cable (D) to the battery pack (E).
5. Attach the cable (F) to the helmet.

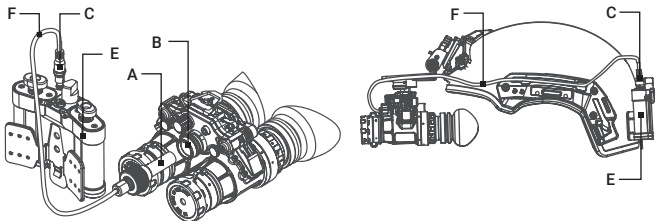

FIGURE 2-4. CONNECTING THE BATTERY PACK

## 2.1.4 DEMIST SHIELDS INSTALLATION

Mount the demist shields to the UNVG as follows.

1. Remove the eyecups from the UNVG eyepieces.
2. Coat the demist shields with an anti-fogging compound, to prevent moisture condensation on the surface of the shields.
3. Insert the demist shield into the eyepieces.
4. Secure the eyecups back into place.

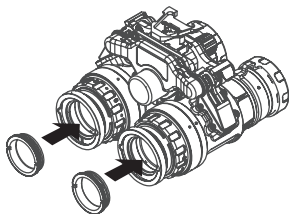

FIGURE 2-5. DEMIST SHIELD INSTALLATION

## 2.1.5 SACRIFICIAL WINDOWS INSTALLATION

Mount the sacrificial windows to the UNVG as follows.

1. Remove the UNVG lens cap.
2. Carefully push the sacrificial windows onto the end of the objective lens of UNVG until it stops.

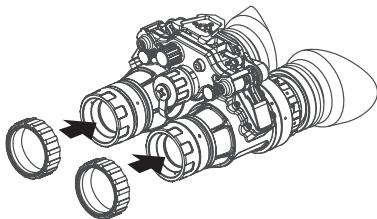

FIGURE 2-6. SACRIFICIAL WINDOW INSTALLATION

## 2.1.6 HELMET MOUNT FOR SHROUD

An optional Dovetail helmet mount can be used to attach the UNVG to the helmet or goggle kit with a shroud. With the helmet mount, the UNVG can be positioned directly in front of the user's eyes, or flipped backwards, out of the field of view.

Mount the UNVG to a helmet or goggle kit as follows (refer to Figure 2-7):

1. Attach the mount (A) to the shroud (B). Place the tab at the top of the mount into the notch at the top of the shroud. Press down on the bottom of the mount and snap it into the shroud.
2. Attache the UNVG. Insert the UNVG dovetail rail into the guide (C) of the helmet mount until it locks into place. To remove the UNVG from the helmet mount, push down on the button (D), and slide the unit out of the guide (C).
3. Put on the helmet or goggle kit with the UNVG attached.
4. Adjust the eye relief. Push the button (E) and move the UNVG along the rail (F).
5. Adjust the vertical position of the UNVG. Turn the lever (G) and move the unit along vertical slide-rail until the most comfortable position is reached. Turn the lever (G) back to lock vertical position.
6. Adjust the UNVG tilt. Turn the lever (H) to change the tilt angle.
7. To flip the UNVG up, press the button (I) and lift the device up until it reaches the top position. Press the same button (I) to lower the UNVG into the proper viewing position.
8. To remove the helmet mount from the shroud, push the release lever (J) on the side of helmet mount.

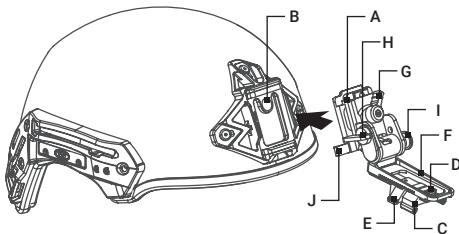

FIGURE 2-7. HELMET MOUNT FOR SHROUD

## 2.2 SYSTEM CONTROLS

### **CAUTION:**

To protect the intensifier tube when the device is not in use or when it is being operated in daylight, keep the protective lens cap securely fitted over the lens.

### 2.2.1 OPERATING SWITCH

The UNVG is controlled by a single switch knob.

#### **Turning On**

To turn on the device, rotate the knob clockwise. You will hear a clicking sound when the device turns on.

#### **Manual Gain Adjustment**

Once UNVG is turned on, the device gain and the image brightness will be at maximum. Continue turning the knob counterclockwise to decrease the gain level. The brightness will also decrease.

#### **IR Illuminator On/Off**

Double-press the switch knob to turn on the built-in auxiliary infrared light. When the IR illumination is turned on, the red LED indicator lights up in the field of view of each eyepiece.

Double-press the knob again to turn off the infrared light.

#### **Low Battery Indicator**

When the binoculars are turned on, a flashing yellow indicator in the eyepiece viewing area indicates a low battery level. This indicator alerts the user when the battery needs to be replaced.

#### **Turning Off**

To turn off the device, turn the knob fully counterclockwise.

### 2.2.2 DIOPTER ADJUSTMENT RINGS

The diopter adjustment ring allows a user to alter the viewfinder to accommodate that individual's eyesight for optimum image sharpness. UNVG has a separate adjustment for each eyepiece. While looking through the eyepiece, rotate the diopter adjustment ring to optimize the sharpness of the image in the viewfinder.

### 2.2.3 FOCUS RING

Bring the object into focus by turning the objective focus ring (counter clockwise for far focus, clockwise for near focus, if you look in the eyepieces). Rotate the focus ring until the subject looks sharp in the viewfinder.

### 2.2.4 INTERPUPILLARY DISTANCE ADJUSTMENT

The night vision device is equipped with adjustment of interpupillary distance. To adjust, firstly turn the fixing knobs (A) counterclockwise to release the positioning plate. Then move the left and right UNVG pods (B) to the appropriate to the pupil distance position. Turn the fixing knobs clockwise to lock the position.

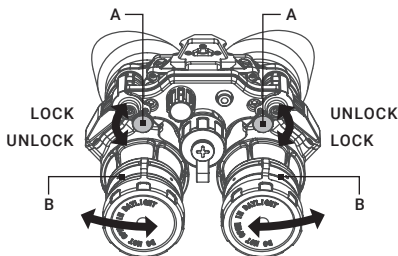

FIGURE 2-8. INTERPUPILLARY DISTANCE ADJUSTMENT

### 2.2.5 AUTO OFF FEATURE

The UNVG is equipped with the function of automatic power on/off when the device is turned over. During use, when the user pulls the one of the device's pods to side to reach a critical angle, the power of this pod will automatically turns off and the device enters the standby state. When the device pod returns to the normal operating position, the power will turn on automatically.

When the user pulls both pods of the device to side to reach a critical angle, the power of both pods will automatically turns off and the device enters the standby state. If one of pod is pulled back to the normal operating position, the power on this side will turn on automatically. At the same

time, if both pods are pulled back to the normal operating position, the system on both sides will return to normal operating state.

If the infrared auxiliary light is turned on, the IR light will be switched off when both pods are rotated to the side and upward. The IR light will be on automatically when one or both of pods returns to the working position.

## 2.2.6 SWITCHING THE EXTERNAL BATTERY PACK

When the external battery pack is connected to the night vision binocular, power from it is turned on by turning the switch knob on the battery pack body from the central position marked "O" to the "L" or "R" position. When the switch is in the "L" position, power is supplied from the batteries in the left compartment of the unit. When the switch is in the "R" position, power is supplied from the batteries in the right compartment of the unit.

To turn off the power from the battery pack, turn the switch to the middle "O" position.

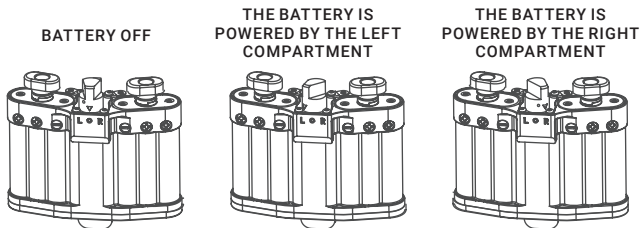

FIGURE 2-9.BATTERY PACK SWITCH STATUS

## 2.3 OPERATING

### 2.3.1 OPERATING PROCEDURES

1. Verify that the battery is installed as indicated on the unit body.

**NOTE:**

Only operate the binocular in dark environments. If it necessary to operate the device in daylight, use the objective lens caps to cover the objective lenses. The pinhole at the center of the lens caps allows to check the operation ability of the device in daylight conditions.

2. Remove the lens cap and place it over the housing of the lens.
3. Turn the function switch knob clockwise. You will hear a clicking sound when the device turns on. After a slight delay, a green or white glow will appear in the eyepieces of the unit.
4. Adjust the unit diopter by rotating the ring of the eyepieces.
5. Observe the scene. Rotate the focus rings until the image is clear and sharp.
6. Adjust the brightness of the image according to the scene using the gain control knob.
7. After the task is completed, turn off the power be turning the switch knob counterclockwise. Cover the objective lens with the caps, remove the device from the helmet/google kit, and put them into the carrying bag. If you do not use the night vision device for a long time, take out the battery.

### 2.3.2 PLACEMENT OPTIONS FOR USE

The left and right UNVG pods can independently roll up and down by not less than 100 degrees, so that the user can quickly change the single / double eye configuration, quickly switch the operation in the weapon operation and the night environment, and improve the night combat efficiency.

Options for placing UNVG on a helmet are shown in Fig. 2-10.

**BINOCULAR GOGGLES POSITION**

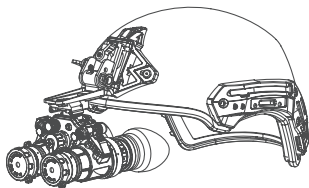

**MONOCULAR GOGGLES POSITION**

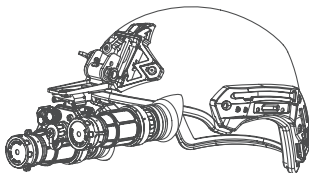

**TOP POSITION**

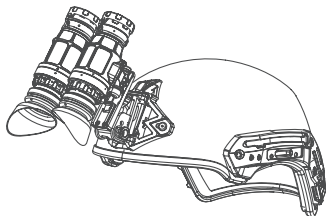

**COMPACT STOWED POSITION**

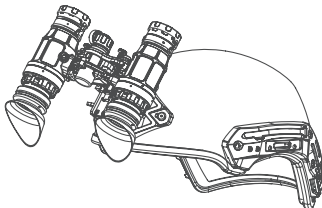

**FIGURE 2-10. UNVG PLACEMENT OPTIONS**

# 3 MAINTENANCE AND TROUBLESHOOTING

## 3.1 MAINTENANCE

### 3.1.1 BATTERY REMOVAL AND REPLACEMENT

Refer to Part 2.1 for battery installation procedures.

### 3.1.2 CLEANING THE UNVG

Wipe the housing with a damp cloth as needed.

#### **CAUTION:**

Do not use abrasives or solvents to clean the housing, lens, or display window. Do not use ammonia-based cleaning products to clean the lens. Doing so may damage the anti-reflective coating of the lens

The UNVG lens is designed for the harsh outdoor environment and has a coating for durability and anti-reflection, but it may require cleaning occasionally. Avoid scratching the lens and/or leaving fingerprints on the optics. Optics can be damaged by improper cleaning. Clean the lens according to the instructions below when image quality degradation is noticed or excessive dirt or other contaminant is on the lens.

Do not use abrasive materials, such as paper or scrub brushes as this will possibly damage the lens by scratching it. Only wipe the lens clean when there is visible contamination on the surface.

#### **PREFERRED METHOD FOR CLEANING THE LENS**

Materials:

- Optical-grade cloth
- Pure water (de-ionized or other)
- Isopropyl alcohol (IPA)

Saturate a piece of the lens tissue with the water and drape it over the lens. Let the surface tension of the water pull the tissue onto the lens surface and then drag the tissue across the lens surface. Repeat several times with different pieces of tissue.

Repeat the same step using IPA instead of water. Drag the final piece of tissue over the lens several times to prevent pooling, which could leave a residue behind.

## 3.2 TROUBLESHOOTING

Table 3-1 common malfunctions that may occur with your equipment. Perform the tests, inspections, and corrective actions in the order listed. This table does not list all the malfunctions that may occur with your device, nor does it include all tests, inspections, or corrective actions that may be necessary to correct them. If you identify an equipment malfunction that is not listed, or the suggested corrective actions do not correct the issue, please contact Customer Support.

TABLE 3-1. OPERATOR TROUBLESHOOTING

MALFUNCTION	PROBABLE CAUSE/ TEST/INSPECTION	CORRECTIVE ACTION
1. Binocular fails to activate.	Visual.  Check for defective, missing, or improperly installed battery.	Turn the power switch to OFF position, and then turn it ON.  Replace the battery or install it correctly.
2. IR source fails to activate.	In a dark location with system turned on, activate IR source.  Visually check IR source operation; scene should brighten.	If the IR source still fails to activate, please contact Customer Support.
3. IR source indicator fails to activate.	Visual.	Please contact Customer Support.

MALFUNCTION	PROBABLE CAUSE/ TEST/INSPECTION	CORRECTIVE ACTION
4. Poor image quality.	<p>Check objective lenses or eyepiece lenses focus.</p> <p>Check for fogging or dirt on the objective and eyepiece lenses.</p>	<p>Refocus.</p> <p>Clean lens surfaces per Paragraph 4.4.1.</p>
5. Light visible around eyecup.	<p>Check eye relief distance.</p> <p>Check eyecups for resiliency.</p>	<p>Adjust for proper eye relief distance.</p> <p>If eyecup is defective, please contact Customer Support.</p>
6. Diopter adjustment cannot be made.	<p>Check to see if the diopter adjustment is bent or broken.</p>	<p>If damaged, please contact Customer Support.</p>
7. Battery cap is difficult to open.	<p>Verify that the O-ring is present.</p> <p>Check for damage to the battery cap.</p>	<p>If the O-ring is missing, please contact Customer Support.</p> <p>If damaged, please contact Customer Support.</p>

## 4 WARRANTY INFORMATION

### 4.1 WARRANTY INFORMATION AND REGISTRATION

#### 4.1.1 WARRANTY INFORMATION

This product is guaranteed to be free from manufacturing defects in material and workmanship under normal use for a period of three (3) years from the date of purchase. In the event that a defect covered by the warranty below occurs during the applicable period stated above, AGM Global Vision, at its discretion, will either repair or replace the product; such action on the part of AGM Global Vision shall be the full extent of AGM Global Vision's liability, and the Customer's sole and exclusive repairation. This warranty does not cover a product if it has been (a) used in ways other than its normal and customary manner; (b) subjected to misuse; (c) subjected to alterations, modifications or repairs by the Customer or by any party other than AGM Global Vision without prior written consent of AGM Global Vision; (d) is the result of a special order or categorized as "close-out" merchandise or merchandise sold "as-is" by either AGM Global Vision or the AGM Global Vision dealer; or (e) merchandise that has been discontinued by the manufacturer and either parts or replacement units are not available due to reasons beyond the control of AGM Global Vision. AGM Global Vision shall not be responsible for any defects or damage that in AGM Global Vision's view are a result from the mishandling, abuse, misuse, improper storage or improper operation of the device, including use in conjunction with equipment that is electrically or mechanically incompatible with, or of inferior quality to, the product, as well as failure to maintain the environmental conditions specified by the manufacturer. This warranty is extended only to the original purchaser. Any breach of this warranty shall be enforced unless the customer notifies AGM Global Vision at the address noted below within the applicable warranty period.

The customer understands and agrees that except for the foregoing warranty, no other warranties written or oral, statutory, expressed or implied, including any implied warranty of merchantability or fitness for a particular purpose, shall apply to the product. All such implied warranties are hereby and expressly disclaimed.

#### **4.1.2 LIMITATION OF LIABILITY**

AGM Global Vision will not be liable for any claims, actions, suits, proceedings, costs, expenses, damages, or liabilities arising out of the use of this product. Operation and use of the product are the sole responsibility of the Customer. AGM Global Vision's sole undertaking is limited to providing the products and services outlined herein in accordance with the terms and conditions of this Agreement. The provision of products sold and services performed by AGM Global Vision to the Customer shall not be interpreted, construed, or regarded, either expressly or implied, as being for the benefit of or creating any obligation toward any third party of legal entity outside AGM Global Vision and the Customer; AGM Global Vision's obligations under this Agreement extend solely to the Customer. AGM Global Vision's liability hereunder for damages, regardless of the form or action, shall not exceed the fees or other charges paid to AGM Global Vision by the customer or customer's dealer. AGM Global Vision shall not, in any event, be liable for special, indirect, incidental, or consequential damages, including, but not limited to, lost income, lost revenue, or lost profit, whether such damages were foreseeable or not at the time of purchase, and whether or not such damages arise out of a breach of warranty, a breach of agreement, negligence, strict liability, or any other theory of liability.

#### **4.1.3 PRODUCT REGISTRATION**

In order to validate the warranty on your product, the customer must complete and submit AGM Global Vision PRODUCT REGISTRATION FORM on our website ([www.agmglobalvision.com/customer-support](http://www.agmglobalvision.com/customer-support)).

#### **4.1.4 OBTAINING WARRANTY SERVICE**

To obtain warranty service on your unit, the End-user (Customer) must notify the AGM Global Vision service department via e-mail. Send any requests to [support@agmglobalvision.com](mailto:support@agmglobalvision.com) to receive a Return Merchandise Authorization number (RMA). When returning any device, please take the product to your retailer, or send the product, postage

paid and with a copy of your sales receipt, to AGM Global Vision's service center at the address listed above. All merchandise must be fully insured with the correct postage; AGM Global Vision will not be responsible for improper postage or merchandise that becomes lost or damaged during shipment. When sending product back, please clearly write the RMA# on the outside of the shipping box. Please include a letter that indicates your RMA#, the Customer's Name, a Return Address, reason for the return, contact information (valid telephone numbers and/or an e-mail address), and proof of purchase that will help us to establish the valid start date of the warranty. Product merchandise returns that do not have an RMA# listed may be refused, or a significant delay in processing may occur. Estimated Warranty service time is 10-20 business days. The End-user/Customer is responsible for postage to AGM Global Vision for warranty service. AGM Global Vision will cover return postage/shipping after warranty repair to the End-user/Customer only if the product is covered by the aforementioned warranty. AGM Global Vision will return the product after warranty service by domestic UPS Ground service and/or domestic mail. Should any other requested, required, or international shipping methods be necessary, the postage/shipping fee will be the responsibility of the End-user/Customer.

For service, repair or replacement, please contact:

**AGM Global Vision, LLC**

**2407 E Interstate 30,**

**Suite 100**

**Grand Prairie, TX 75050**

**USA**

**Tel. +1.928.333.4300**

**info@agmglobalvision.com**

**www.agmglobalvision.com**

# 5 SPECIFICATIONS

## 5.1 GOGGLES SPECIFICATIONS

	UNVG	UNVG-RPO	UNVG-51
<b>Optical Specifications</b>			
Magnification	1×		
FOV	40°	40°	51°
Lens System	25 mm; F/1.23	25 mm; F/1.23	19 mm; F/1.26
Exit Pupil Diameter	14 mm	14 mm	12 mm
Focus Range	0.25 m to infinity		
Diopter Adjustment	-6D to +2D		
Eye Relief	25 mm	25 mm	17 mm
<b>System Specifications</b>			
Manual Gain Control	Yes		
Auto-Off System	Yes		
Infrared Illuminator	Yes		
<b>Power</b>			
Battery Type	One AA (1.5 V) or External Battery Pack (four AA or two CR123A)		
Battery Life (IR off)	One AA - up to 15 hours External Battery Pack with four AA - up to 50 hours External Battery Pack with two CR123A - up to 30 hours		

	UNVG	UNVG-RPO	UNVG-51
<b>Environmental</b>			
Operating Temperature	-40°C to +50°C (-40°F to +122°F)		
Storage Temperature	-50°C to +70°C (-58°F to +158°F)		
Protection Level	IP67		
<b>Physical</b>			
Interpupillary Distance	56 to 72 mm		
Dimensions	101×116×85 mm (4.0×4.6×3.3 in)	101×116×85 mm (4.0×4.6×3.3 in)	101×116×85 mm (4.0×4.6×3.3 in)
Weight	500 g (1.1 lb)	475 g (1.0 lb)	550 g (1.2 lb)

## 5.2 BATTERY PACK SPECIFICATIONS

<b>Power</b>	
Battery Type	Four AA or two CR123A
<b>Environmental</b>	
Operating Temperature	-40°C to +50°C (-40°F to +122°F)
Storage Temperature	-50°C to +70°C (-58°F to +158°F)
Protection Level	IP67
<b>Physical</b>	
Dimensions	102 × 86 × 34 mm (4.0 × 3.4 × 1.3 in)
Weight	250 g (0.55 lb)

*All data are subject to change without notice.*



**AGM Global Vision, LLC**

**MAIN OFFICE**

2407 E Interstate 30,  
Suite 100  
Grand Prairie, TX 75050  
USA  
Tel. +1.928.333.4300  
info@agmglobalvision.com  
www.agmglobalvision.com

**EUROPEAN OFFICE**

#6 Andrey Lyapchev Blvd  
Sofia, P.C. 1756  
Bulgaria  
Tel. +35.988.560.0326  
info@agmglobalvision.eu  
www.agmglobalvision.eu

**AGMglobalvision.com**