

# **SPECTRUM 4K-MINI**

DIGITAL DAY & NIGHT VISION  
RIFLE SCOPE

**USER MANUAL**

© 2025 AGM Global Vision, LLC. All rights reserved.

This documentation is subject to change without notice.

No parts of this manual, in whole or in part, may be copied, photocopied, translated, or transmitted by any electronic medium or in machine-readable form without the prior written permission of AGM Global Vision, LLC.

If you have questions that are not covered in this manual, or need service, contact AGM Global Vision customer support for additional information prior to returning a product.

## **AGM Global Vision, LLC**

**2407 E Interstate 30, Suite 100**

**Grand Prairie, TX 75050**

**Tel. 928.333.4300**

**support@agmglobalvision.com**

**www.agmglobalvision.com**

## **EXPORT INFORMATION**

Buyer acknowledges that all products supplied by AGM Global Vision, LLC are subject to U.S. export control laws, including, but not limited to, the Export Administration Regulations, the International Economic Emergency Powers Act, and various U.S. embargoes and sanctions. AGM Global Vision products may not be exported, re-exported, or transferred contrary to U.S. export control laws. In particular, AGM Global Vision products may not be exported, re-exported, or transferred to prohibited countries, individuals, organizations, or entities, including but not limited to those individuals and entities listed on the List of Specially Designated Nationals and Blocked Persons administered or maintained by the U.S. Office of Foreign Assets Control ("OFAC"), the various lists maintained by the Bureau of Industry and Security of the Department of Commerce, and the U.S. State Department and Buyer represents and warrants that neither Buyer nor any of its officers, directors, or employees are on such lists. Distribution or resale by Buyer to such countries, individuals, organizations, or entities is expressly prohibited. Buyer has and will maintain a positive process to ensure compliance with this Section.

## FCC INFORMATION

Please take attention that changes or modification not expressly approved by the party responsible for compliance could void the user's authority to operate the equipment.



This equipment complies with FCC/IC RSS-102 radiation exposure limits set forth for an uncontrolled environment.

FCC compliance: This product has been tested and found to comply with the limits for a Class B digital device, pursuant to Part 15 of the FCC Rules. These limits are designed to provide reasonable protection against harmful interference in a residential installation. This product generates, uses, and can radiate radio frequency energy and, if not installed and used in accordance with the instructions, may cause harmful interference to radio communications. However, there is no guarantee that interference will not occur in a particular installation. If this product does cause harmful interference to radio or television reception, which can be determined by turning the equipment off and on, the user is encouraged to try to correct the interference by one or more of the following measures:

- Reorient or relocate the receiving antenna.
- Increase the separation between the equipment and receiver.
- Connect the equipment into an outlet on a circuit different from that to which the receiver is connected.
- Consult the dealer or an experienced radio/TV technician for help.

### FCC Conditions

This device complies with part 15 of the FCC Rules. Operation is subject to the following two conditions:

1. This device may not cause harmful interference.
2. This device must accept any interference received, including interference that may cause undesired operation.

## EU CONFORMITY STATEMENT



This product and - if applicable - the supplied accessories too are marked with "CE" and comply therefore with the applicable harmonized European standards listed under the EMC Directive 2014/30/EU, the RoHS Directive 2011/65/EU



2012/19/EU (WEEE directive): Products marked with this symbol cannot be disposed of as unsorted municipal waste in the European Union. For proper recycling, return this product to your local supplier upon the purchase of equivalent new equipment, or dispose of it at designated collection points. For more information see: [www.recyclethis.info](http://www.recyclethis.info)



Regulation (EU) 2023/1542 (Battery Regulation): This product contains a battery and it is in conformity with the Regulation (EU) 2023/1542. The battery cannot be disposed of as unsorted municipal waste in the European Union. See the product documentation for specific battery information. The battery is marked with this symbol, which may include lettering to indicate cadmium (Cd), or lead (Pb). For proper recycling, return the battery to your supplier or to a designated collection point. For more information see: [www.recyclethis.info](http://www.recyclethis.info).

# LIST OF CONTENTS

TITLE	PAGE
Safety Summary	6
<b>1. GENERAL INFORMATION</b>	<b>8</b>
1.1 System Description	8
1.2 Standard Components	10
1.3 Optional Equipment	11
1.4 Key Features	12
<b>2. OPERATING INSTRUCTIONS</b>	<b>13</b>
2.1 Basic Operations	13
2.2 Main Function	22
2.3 Client Software Introduction	40
<b>3. MAINTENANCE</b>	<b>41</b>
3.1 Maintenance	41
3.2 Troubleshooting	42
<b>4. WARRANTY INFORMATION</b>	<b>44</b>
4.1 Warranty Information and Registration	44
<b>5. SPECIFICATIONS</b>	<b>47</b>
5.1 Specifications	47
5.2 Reticle Parameters	49

# SAFETY SUMMARY

- Read and follow all instructions
- Read all warnings
- Only use the attachments/accessories specified by the manufacturer
- All service must be provided by the manufacturer

## **WARNING:**

This product contains natural rubber latex, which may cause potentially fatal allergic reactions! If you are allergic to latex, it is important that you strictly avoid exposure to products that contain it.

## **WARNINGS AND CAUTIONS:**

### **Transportation**

- Keep the device in original or similar packaging while transporting it.
- Keep all wrappers after unpacking them for future use. In case of any failure occurred, you need to return the device to the factory with the original wrapper. Transportation without the original wrapper may result in damage on the device and the company shall not take any responsibilities.
- DO NOT drop the product or subject it to physical shock. Keep the device away from magnetic interference.

### **Battery**

- Improper use or replacement of the battery may result in explosion hazard. The built-in battery size should be 23×67 mm, the rated voltage is 3.635 V, and the battery capacity is 3.35 Ah. The external battery size should be 19×70 mm, the rated voltage is 3.635 V, and the battery capacity is 3.3 Ah.
- For long-term storage of the device, make sure it is fully charged every half year to ensure the battery quality. Otherwise, damage may occur.
- Do not charge other battery types with the supplied charger. Confirm there is no flammable material within 2 m of the charger during charging.
- Make sure the device temperature is between 0°C to 45°C (32°F to 113°F) when charging.
- DO NOT place the device near heating or fire source. Avoid direct sunlight.
- Please use the supplied charger to charge the battery.

## **Maintenance**

- If the product does not work properly, please contact your dealer or the nearest service center. We shall not assume any responsibility for problems caused by unauthorized repair or maintenance.
- Wipe the device gently with a clean cloth and a small quantity of ethanol, if necessary.
- If the equipment is used in a manner not specified by the manufacturer, the protection provided by the device may be impaired.
- It is recommended to reboot the device every 2 hours when using it to ensure the device performance.

## **Using Environment**

- Make sure the running environment meets the requirement of the device. The operating temperature shall be -30°C to 55°C (-22°F to 131°F), and humidity shall be 5% to 95%.
- DO NOT expose the device to high electromagnetic radiation or dusty environments.
- DO NOT aim the lens at the sun or any other bright light.
- Place the device in a dry and well-ventilated environment.

## **EMERGENCY:**

If smoke, odor, or noise arises from the device, immediately turn off the power, unplug the power cable, and contact the service center.

# 1 GENERAL INFORMATION

## 1.1 SYSTEM DESCRIPTION

The Spectrum 4K-Mini digital day & night vision scope from AGM utilizes practically all features that shooters have come to know and love in the Spectrum LRF 4K (except laser rangefinder), but in smaller and lighter body. Spectrum 4K-Mini is based on an advanced high-resolution 3840×2160 detector, which works in conjunction with a high quality 1920x1080 OLED display. This new display allows users the ability to switch from a semi-circular interface to a rectangular interface. Also added the ability to switch the image refresh rate to 100 Hz, that enhances image fluidity, particularly useful for fast-moving targets.

The Spectrum 4K-Mini is one step in the continuous evolution of full color digital electro-optics. New and improved 4K digital sensors are now naturally more sensitive to infrared than older models once were, which means the unit should require much less external Infrared light while used in night mode. The Spectrum 4K-Mini is literally built for prime, legal daytime hunting hours in the precious minutes just after sunrise and just prior to sunset.

Power is supplied by a built-in rechargeable Li-ion battery and an additional replaceable 18650 battery. An 8-hour battery life provides users with more than enough time behind the eyepiece during hunting season. The internal storage capacity, which comes in at a robust 32GB, which will come in handy when recording in high resolution. If you're looking for an exceptionally capable technological optic, the Spectrum 4K-Mini is the perfect addition to your arsenal.

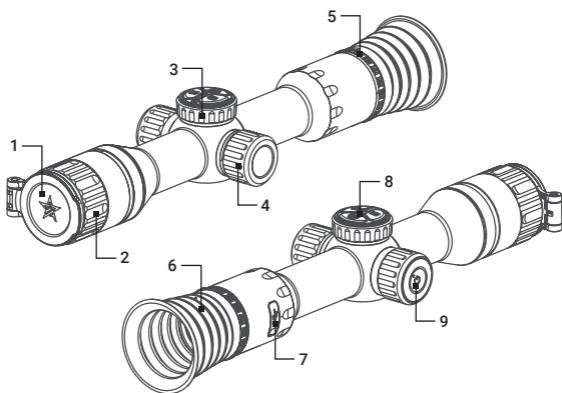

**FIGURE 1-1. MAIN PARTS**

**TABLE 1-1. MAIN PARTS**

ITEM	DESCRIPTION
1	Lens Cap
2	Focus Ring
3	Navigation Wheel
4	Battery Cover
5	Diopter Adjustment Ring
6	Eyepiece
7	USB Interface Cover
8	Operating Buttons
9	ON/OFF Button

## 1.2 STANDARD COMPONENTS

The standard components are shown in Figure 1-2 and listed in Table 1-2.

The ITEM column indicates the number used to identify items in Figure 1-2.

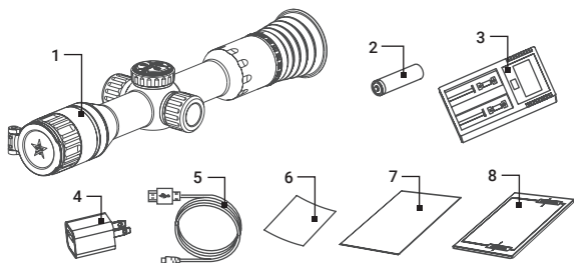

FIGURE 1-2. STANDARD COMPONENTS

TABLE 1-2. STANDARD COMPONENTS

ITEM	DESCRIPTION	QUANTITY
1	Rifle Scope	1
2	18650 Rechargeable Battery	1
3	18650 Battery Charger	1
4	Power Adapter	1
5	Type-C USB Cable	1
6	Lens Cloth	1
7	Quick Start Guide	1
8	User Manual	1

## 1.3 OPTIONAL EQUIPMENT

Optional equipment is shown in Figure 1-3 and listed in Table 1-3.

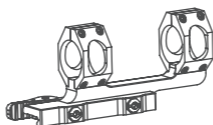

FIGURE 1-3. ADM QUICK RELEASE MOUNT

TABLE 1-3. OPTIONAL EQUIPMENT

DESCRIPTION	PART NO.
AGM-2116 ADM Quick Release Mount. One-piece 30mm quick release mount. 1.47" (37.3 mm) centerline height.	63061161

## 1.4 KEY FEATURES

- Incredible low light gathering capability
- Full 4K color day mode
- 3.5-20.5x incremental and step zoom capability
- 3840x2160 ultra-high-definition CMOS sensor
- Both 50 Hz and 100 Hz refresh rate capable
- Detection range up to 800m (day)
- 1920×1080 resolution OLED display
- Various reticle types and colors
- On-board video/audio recording and image capture
- Shot-Activated Recording (SAR)
- 32GB EMMC built-in storage
- Wi-Fi data transmission
- AGM Connect App compatibility
- Waterproof & Shockproof
- Standby mode
- Dual power system
- Up to 7.8 hours continuous operation
- External power supply capability
- 3-year warranty

## 2 OPERATING INSTRUCTIONS



### 2.1. BASIC OPERATIONS

#### 2.1.1 UNPACKING

The following steps must be completed prior to each mission.

1. Open the packaging box, remove the device, and verify that all components are included.
2. Inspect the device for any obvious evidence of damage to the optical surfaces, body, eyecup, operation buttons, etc. Ensure that all optical surfaces are clean and ready for use. Clean all optical surfaces with a lens tissue.

#### 2.1.2 CHARGING THE BUILT-IN BATTERY

When the device is turned on, the battery indicator on the screen shows the built-in battery status. Icon  means the internal battery is fully charged, icon  means that the battery is low.

When the low power note shows, charge the battery.

#### **NOTE:**

Please charge the battery with the included USB cable and power adapter. The charging temperature should be 0°C to 45°C (32°F to 113°F).

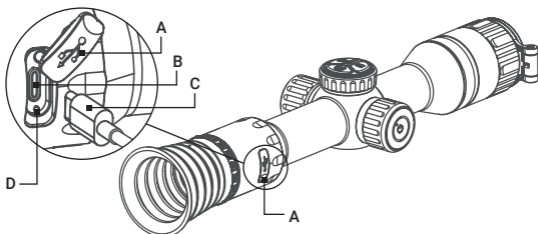



FIGURE 2-1. USB INTERFACE

1. Open the USB interface cover (Figure 2-1, A).
2. Connect the power adapter to the scope's interface port (B) using the USB cable (C).
3. Plug in the power adapter and charge the built-in battery. Icon  in the FOV of scope indicates the charging process. The green icon  means the battery is fully charged. The color LED (D) near USB port indicates the charging status. Charge the device for more than 6 hours before first use.

**TABLE 2-1. CHARGING STATUS INDICATION**

INDICATOR	FUNCTIONS
Flashing Red & Green	Error occurred.
Solid Red	Battery is properly charging.
Solid Green	Battery is fully charged.
Off	Battery is not charged.

### 2.1.3 ADDITIONAL 18650 BATTERY INSTALLATION

1. Turn the battery cover (Figure 2-2, A) counterclockwise to open it.
2. Insert 18650 rechargeable battery (B) into the battery compartment (C) with the positive mark inward.
3. Turn the battery cover clockwise to tighten it.

The battery icon  on the screen indicates the status of the additional (External) battery. Charge the 18650 battery using the included battery charger.

The green arrow above the battery icon  shows which battery is currently being used.

#### **NOTE:**

Remove the additional battery from the battery compartment if the device is not used for a long time.

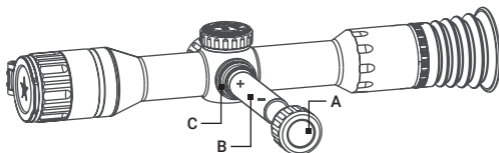

**FIGURE 2-2. ADDITIONAL BATTERY INSTALLATION**

## 2.1.4 CONTROL BUTTONS

The Spectrum 4K-Mini controls are shown in Figures 2-3 and are defined in Tables 2-2.

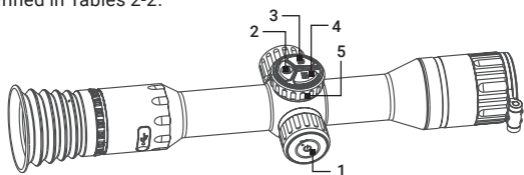











FIGURE 2-3. SPECTRUM 4K-MINI CONTROLS

Each button is responsible for some functions selected by short press or long press (hold) the button. Pushing a button for 2+ second is considered “long press” (hold).

TABLE 2-2. SPECTRUM 4K-MINI CONTROL FUNCTIONS

ITEM	CONTROLS	FUNCTIONS
1	 POWER BUTTON	Press: Standby mode / Wake up device Hold: Power ON/OFF
2	 MODE BUTTON	Press: Switching scene mode (Day, Night, Green, Yellow and Auto) Hold: Enable/Disable PIP
3	 CAPTURE BUTTON	Press: Image capture Hold: Start/Stop video recording
4	 MENU BUTTON	Hold: Enter menu <b>Menu Mode</b> Press: Confirm / Set parameters Hold: Exit menu
5	NAVIGATION WHEEL	Rotate: Setting the magnification <b>Menu Mode</b> Rotate: Navigation menu

Press and hold the MODE  and MENU  buttons simultaneously to set the frame rate to 50Hz or 100Hz (see 2.2.12 for details).

Hold down the MODE button  and CAPTURE button  simultaneously to lock the navigation wheel to prevent accidental turning or pressing. If the wheel is locked, the icon  will be

displayed on the screen when MENU button pushed. When unlocked, the icon will change to .

## 2.1.5 POWER ON AND OFF

### Power On

When the device is connected to cable or the battery is enough, press and hold the POWER button  to turn on the device. The red LED power indicator in the POWER button will light up.

### Power Off

When the device is turned on, hold the POWER BUTTON  to power off the device.

### Auto Power Off

In the “Auto Power Off” submenu of General Settings you can set the time for the automatic shutdown of the device as required (see 2.2.27 for details).



The Auto Power Off countdown will start again when the device exits standby mode, or the device is restarted.

## 2.1.6 AUTO SCREEN OFF

Auto Screen Off function darkens the screen to save energy and increase battery time. However, the device stays on and you can view the live view on AGM Connect app when connecting the device to the app. The integrated algorithm automatically detects scope’s exact position and activates the Auto Screen Off function (see 2.2.15 for details).

## 2.1.7 STANDBY MODE

Standby mode is used to save battery power. In this mode, some power-consuming features such as the display, network hardware, or internal storage will be temporarily disabled.

In live view mode, press the POWER button . After a few seconds, the display will turn off. Press the POWER button  again to exit the Standby mode.

When the Auto Screen Off function is enabled, you can also tilt or rotate the device to wake it from standby mode.

## 2.1.8 OBSERVATION

1. Power on the device.
2. Rotate the diopter adjustment ring until the on-screen display (OSD) text or image is clear. Once completed, diopter adjustment will no longer be needed again until the device is used by a new user.

3. Point the device towards the target of the view. Bring the object into focus by rotate the objective focus ring.

#### NOTE:

You must perform the focus adjustment before any further use of the rifle scope.

4. Select the proper scene mode according to the lighting conditions to improve the display effect. Press the MODE button  to set Day, Night, Green, Yellow or Auto mode.

**Day:** This mode can be used at daytime and in bright light.

**Night:** This mode can be used at dusk and at night.

**Green:** It's a night vision mode. You can use this mode according to your personal preference.

**Yellow:** It's a night vision mode. You can use this mode according to your personal preference.

**Auto:** The Day mode and Night mode switch automatically according to the ambient brightness.

5. Set brightness and contrast, and activate WDR (Wide Dynamic Range) in the menu enhance the viewing experience by providing better image quality in diverse lighting conditions.

### 2.1.9 ON-SCREEN DISPLAY (OSD)

On-screen interface displays the menu items and device status indicators. Adjust the On-Screen Display (OSD) in the Function Settings menu (see 2.2.18).

When OSD is on, the information of shot activated recording function (prerecord video), Wi-Fi hotspot activation, battery status, current magnification setting, time and date displays on the screen.

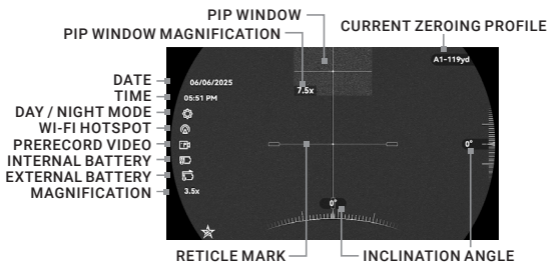

FIGURE 2-4. ON-SCREEN DISPLAY

The screen can also display the reticle, current zeroing profile, zeroing distance, distance measurement result and the pitch scales. You can configure the display of all these elements in the scope's menu.

### 2.1.10 DIGITAL ZOOM

In live view mode, rotate the navigation wheel to switch the magnification of the device from 3.5× to 20.5× using digital zoom. The image magnification value is displayed on the screen. The digital zoom step of 0.5x, 1×, 2×, 3×, or 4× can be set in the menu.

### 2.1.11 PICTURE IN PICTURE

The Picture-in-Picture (PIP) mode allows you to see simultaneously both a magnified image of the central part in a PIP window and the main image. The PIP window is displayed at the up-center of the live view.

In the live view you can enable or disable the PIP function by holding MODE button . The current magnification of PIP view will be displayed in the corner of the PIP window.

#### **NOTE:**

- When the reticle is enabled, the PIP view displays a magnified area around the centre of the crosshair. When the reticle is not enabled, the PIP view displays a magnified central area of the image.
- If the PIP function is activated, the image will be enlarged by the zoom factor only in the PIP window.

### 2.1.12 VIDEO RECORDING AND IMAGE CAPTURE

#### **Video Recording**

In the live view interface, hold the CAPTURE button  to start/stop video recording. Recording time information is displayed on the screen.

#### **Image Capture**





In the live view interface, press the CAPTURE button  to capture image.

#### **NOTE:**

When captured, the image freezes for 1 second and a prompt shows on the display.

For exporting captured videos and pictures, refer to Files Export.

## 2.1.13 FILE EXPORT

1. Hold the MENU button  to bring up the menu.
2. Go to  **Advanced Settings**, rotate the wheel to select  **Function Settings** and press the MENU button  to enter the configuration interface.
3. Rotate the wheel to select **USB Flash Drive** mode and press the MENU button  to confirm.
4. Connect the scope to your PC with USB cable. Make sure the device is turned on when connecting the cable.
5. Open the detected disk. The directory is named by the current date. Enter **AGM Content > "Date"** to view the videos and snapshots.
  - Select and copy the videos to PC and play the file with the player.
  - Select and copy the snapshots to PC and view the files.
6. Disconnect the device from your PC.

### **NOTE:**

- The device displays image when you connect it to PC. But functions such as recording, capture and hot spot are disabled.
- When you connect the device to PC for the first time, it installs the drive program automatically.

You can also download files from the scope to your phone using the AGM Connect app (see section 2.3).

## 2.1.14 INSTALLING THE SPECTRUM 4K-MINI ON A PICATINNY/WEAVER RAIL WITH SCOPE RINGS

### **WARNING:**

Always make sure your firearm is unloaded before you place the scope on the firearm. Reconfirm that the chamber is empty if you stop the procedure then resume later. Safe firearms handling rules should be followed at all times.

### **NOTE:**

Mounts are not included and must be purchased separately.

The Spectrum 4K-Mini scope can be mounted on a Picatinny/Weaver rail using pair of 30mm scope rings (Figure 2-5).

1. Remove every screw (A) along with the upper parts (B) of the scope rings.

- Loosen the fixing screws (C) of the lower parts (D) of the rings and install them on the rail.
- Then, you can try to fit the scope before placing the upper rings. The scope rings need to be at a proper distance from the objective bell as well as the turrets so that the eye relief adjustment can be done.
- You can insert a thread locker and tighten the fixing screws of the lower parts of the rings.
- Place the upper rings and slightly fixing them with the screws only enough to allow the scope to rotate and move back and forth.
- Adjust the eye relief. Position the scope far enough to keep your eye safe from recoil.
- Turn on the power of the scope and activate the reticle.
- With the rifle held level, rotate the scope until the reticle is precisely vertical and horizontal.
- Check the position of the scope and tighten the ring screws. Ensure an even fit by alternately tightening the screws.

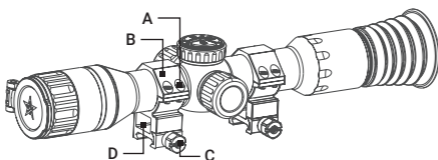

**FIGURE 2-5. INSTALLATION WITH SCOPE RINGS**

### **2.1.15 INSTALLING THE SPECTRUM 4K-MINI ON A PICATINNY/WEAVER RAIL WITH AGM QUICK RELEASE MOUNT**

The Spectrum 4K-Mini scope can be mounted on a Picatinny/Weaver rail using optional AGM quick release (QR) mount (Figure 2-6).

- Unlock the clamping devices of the QR mount by pushing down on the lever holders (A) and unlocking the levers (B).
- Install the mount on the Picatinny/ Weaver rail so that the stops (C) slide into the transverse slots on the rail.
- Affix the mount to the rail by locking the levers (B).
- Verify that the clamping devices are firmly holding the mount. If necessary, adjust each clamping device's lever-cam lock as detailed below:

- 1) Remove the QR mount from the rail.
- 2) With the clamping device unlocked, push the cam (D) towards the arrow, which will cause the nut (E) to slide out of its hole.
- 3) To tighten/ loosen the clamping device, push down on the cam (D) and turn the nut (E) CW/ CCW respectively, in one-two increments (see note below). Much like when the cam (D) is released, backward-moving spring will cause the nut (E) to slide back into its hole.

**NOTE:**

The eight-sided nut of the mount lever-cam lock will only fit into their hole if turned in one of the discrete positions, using increments equal to  $360^{\circ}/8$ .



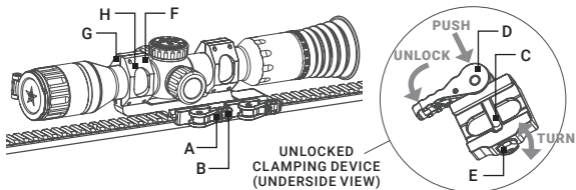

- 4) Verify that the adjusted lever-cams lock securely hold the mounting rail.
5. Remove all screws (F) along with the ring halves (G) and (H) (you can remove the QR mount from the rail for convenience).
6. Place the scope between the halves of the rings and slightly fixing it with the screws (F) only enough to allow the scope to rotate and move back and forth.
7. Place the QR mount with the scope mounted on the rail and affix it by locking the levers. Adjust the eye relief. Position the scope far enough to keep your eye safe from recoil.
8. Turn on the power of the scope and activate the reticle.
9. With the rifle held level, rotate the scope until the reticle is precisely vertical and horizontal.
10. Check the position of the scope and tighten the ring screws. Ensure an even fit by alternately tightening the screws.





**FIGURE 2-6. INSTALLATION WITH QUICK RELEASE MOUNT**

## 2.2 MAIN FUNCTIONS

### 2.2.1 MENU OPERATION

When the device is turned on, press and hold the MENU button  to display the menu. Make sure the wheel is unlocked. Press and hold two buttons  +  at the same time to lock/unlock the wheel. The symbol  is displayed on the screen when wheel is unlocked and the symbol  is displayed if the wheel is locked.

Rotate the navigation wheel to move between menu items. The active element is highlighted in red. Press the MENU button  to select menu item or change an option. Hold the MENU button  to exit the menu.

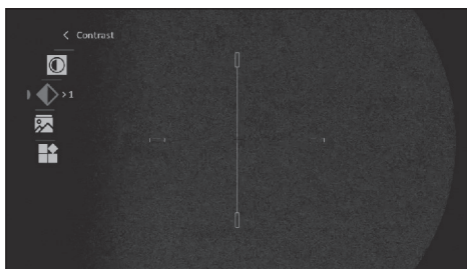

































FIGURE 2-7. MAIN MENU











TABLE 2-3. MENU FUNCTIONS

MENU ITEM	SYMBOL	OPTION	FUNCTION
<b>BRIGHTNESS</b>		Auto / Manual (10 Levels of Brightness)	Adjusts the image brightness.
<b>CONTRAST</b>		10 Levels of Contrast	Adjusts the image contrast.
<b>ALBUMS</b>		View/Delete the local files	
<b>ADVANCED SETTINGS</b>		Advanced Settings Menu	





**TABLE 2-4. ADVANCED SETTINGS MENU**

MENU ITEM	SYMBOL	OPTION	FUNCTION
<b>NETWORK</b>		Close / Hotspot	Enables or disables the Wi-Fi hotspot.
<b>ZEROING PROFILES</b>		5 Profiles (A/B/C/D/E)	Zeroing profile selection with user saved zeroing settings.
<b>ZEROING</b>		<b>Zeroing Menu:</b>	
Zeroing		OFF / 1 / 2 / 3 / 4 / 5	Zeroing settings selection or disable reticle.
Bullet		Bullet Name	Setting the bullet name (9 characters).
Type		10 Reticle Type	Setting the reticle type.
Reticle Color		8 Reticle Colors	Setting the reticle color (white, grey, black, red, green, yellow, blue, orange).
Reticle Center Color		8 Reticle Center Colors	Setting the reticle center color (white, grey, black, red, green, yellow, blue, orange).
<b>Correction</b>		<b>Correction Menu:</b>	
Distance		Distance	Setting the distance to the target.
Zoom		3.5x / 7x / 14x / 28x	Setting the magnification with Digital Zoom.
Freeze Screen		OFF / ON	Image freeze.
X/Y Axis		X / Y	Setting the X-axis and Y-axis corrections.

MENU ITEM	SYMBOL	OPTION	FUNCTION
<b>ZOOM</b>		<b>Zoom Menu:</b>	
<b>Reticle Mode</b>		Fixed / Central	Set Reticle Mode.
<b>Zoom Step</b>		0.5x, 1x, 2x, 3x, 4x	Setting the digital zoom step.
<b>PRERECORD</b>		OFF / 5s / 10s / 15s	Setting the recording time before and after the recoil activation.
<b>FRAME RATE</b>		50FPS / 100FPS	Setting the frame rate.
<b>WDR</b>		OFF / ON	Provides better image quality in various lighting conditions.
<b>MEASURE</b>		Grey Wolf / Brown Bear / Deer / Custom	Measures the distance between the target and the observation position.
<b>AUTO SCREEN OFF</b>		OFF / ON	Function darkens the screen to save energy.
<b>AUDIO</b>		OFF / ON	Enable or disable audio recording.
<b>SMART IR</b>		OFF / ON	Function helps to adjust the overexposed image.
<b>FUNCTION SETTINGS</b>		<b>Function Settings Menu:</b>	
<b>OSD</b>		OSD / Time / Date	Enables or disables OSD, time, date.
<b>Pitch Scale</b>		OFF / ON	Enables or disables Pitch Scale to view the device inclination angle in the live view.
<b>Brand Logo</b>		OFF / ON	Enables or disables Brand Logo on the screen.
<b>USB Flash Drive</b>		USB Flash Drive / Digital	USB port mode settings.

MENU ITEM	SYMBOL	OPTION	FUNCTION
<b>GENERAL SETTINGS</b>		<b>General Settings Menu:</b>	
Language		27 Languages	Choice of interface language.
Display Interface Shape		Circular / Rectangular	Switch between the circular and rectangular display interface shape.
Time		12 / 24 hour	Time setting.
Date		Month / Day / Year	Date setting.
Unit		yd / m	Sets the distance unit.
Auto Power Off		OFF / 15 min / 30 min / 45 min	Setting the automatic shutdown time.
Reboot		---	Reset the basic settings: Brightness, Contrast, PIP, etc.
Restore Factory Settings		---	Restoring the default device settings and zeroing settings, erase all internal storage content.
Version		---	Firmware version, serial number and free space of built-in storage.

## 2.2.2 BRIGHTNESS ADJUSTMENT





1. Hold the MENU button  to bring up the menu.
2. Rotate the wheel to select  **Brightness** menu item and press the MENU button  to confirm.
3. Rotate the wheel to select **Auto** or **Manual** brightness adjustment mode and press the MENU button  to confirm.

**Auto:** Adjust the brightness automatically according to ambient brightness.

**Manual:** Adjust the brightness manually. Rotate the wheel to adjust the brightness. You can select one of ten levels of the brightness to adjust the image lighter or darker.



4. Press the MENU button  to confirm.

### 2.2.3 CONTRAST ADJUSTMENT

1. Hold the MENU button  to bring up the menu.
2. Rotate the wheel to select  Contrast menu item and press the MENU button  to confirm.
3. Rotate the wheel to adjust the image contrast. You can select one of ten levels of the contrast.
4. Press the MENU button  to confirm.



### 2.2.4 ALBUMS

Captured images and recorded videos are automatically stored in the device, and you can view the files in local albums.

1. Hold the MENU button  to bring up the menu.
2. Rotate the wheel to select  Albums menu item and press the MENU button  to confirm.



#### **NOTE:**

The albums are automatically created and named by year + month. The local pictures and videos of a certain month are stored in the corresponding album. For example, the pictures and videos of June in 2025 are saved in the album named "202506".



3. Rotate the wheel to select the album, and press the MENU button  to enter the selected album.
4. Rotate the wheel to select a file to view.
5. Press the MENU button  to view the selected file and relevant information.

#### **NOTE:**

Files are arranged in chronological order, with the most recent at the top. If you fails to find the most recently taken snapshots or videos, please check the time and date settings of your device. When you are viewing files, you can switch to other files by rotating the wheel.





When viewing files, you can press the MODE button  to go to next page, and press the CAPTURE button  to return to the previous page.

While viewing a video, you can press the MENU button  to play or stop the video.

For deleting an album or a file, you can press  +  buttons simultaneously to call the dialogue box, and delete the album or file according to the prompt.

## 2.2.5 NETWORK CONFIGURATION

Connect your phone to the Wi-Fi hotspot of the rifle scope, you can configure the parameters and realize functions of the device.

1. Hold the MENU button  to bring up the menu.
2. Go to  **Advanced Settings**, rotate the wheel to select  **Network** menu item and press the MENU button  to confirm.
3. Rotate the wheel to select **Close** (Hotspot off) or **Hotspot** and press the MENU button  to confirm.







Open the AGM Connect App and connect your phone with the device (refer to Section 2.3). You can view the interface of rifle scope on your phone and take a picture or record video.

### **NOTE:**

When the power is less than 15%, the Wi-Fi hotspot function will be turned off automatically.

## 2.2.6 ZEROING PROFILES

The user can customize and save five profiles with different reticle settings. In each profile, you can configure up to five types of reticle, firing distances and reticle corrections.

1. Hold the MENU button  to bring up the menu.
2. Rotate the wheel to select  **Advanced Settings** item and press the MENU button  to confirm.
3. Rotate the wheel to select  **Zeroing Profiles** and press the MENU button  to confirm.
4. Rotate the wheel to switch the zeroing profile (A, B, C, D, E).
5. Press the MENU button  to confirm.

The right top of the image displays the current zeroing profile information. For example, "A1-50m" means you are using the Zeroing setting 1 in the Profile A, and the set range is 50 m.









### **NOTE:**

There are 5 zeroing profiles in total, and you can configure 5 reticles, zeroing distances and corrections in each zeroing profile.

## 2.2.7 ZEROING







You can select a reticle in the current zeroing profile, and set parameters such as reticle type, color, and boresight correction (coordinates) for a set distance.

Select a zeroing profile initially (refer to 2.2.6).

1. Hold the MENU button  to bring up the menu.
2. Rotate the wheel to select  **Advanced Settings**, and press the MENU button  to confirm.
3. Rotate the wheel to select  **Zeroing** menu item and press the MENU button  to enter the zeroing setting interface. Rotate the wheel to move between submenu and options.
4. Select  **Zeroing** and set the sequence number from 1 to 5. You can also select **OFF** to disable the reticle.
5. Set reticle type (for parameters of all built-in reticles, see part 5.2).
  - 1) In the zeroing setting interface rotate the wheel to select  **Type** submenu and press the MENU button  to confirm.
  - 2) Rotate the wheel to select a reticle pattern and press the MENU button  to confirm.

### **NOTE:**

The scale intervals of Reticle 4 and 7 change synchronously under the current digital zoom.

6. Set reticle color.
  - 1) In the zeroing setting interface rotate the wheel to select  **Color** submenu and press the MENU button  to confirm.
  - 2) Rotate the wheel to select one of eight colors and press the MENU button  to confirm.
7. Set reticle center color.
  - 1) In the zeroing setting interface rotate the wheel to select to select  **Reticle Center Color** submenu and press the MENU button  to confirm.
  - 2) Rotate the wheel to select one of eight colors and press the MENU button  to confirm.
8. (Optional) Repeat 4 to 7 to set type and color for other reticles in this profile.
9. Hold the MENU button  to save and exit.

## 2.2.8 BORESIGHTING / SETTING YOUR ZERO







Like any daytime rifle scope or red dot, sighting in is both similar, and simplified. The Spectrum 4K-Mini comes with a one-shot zeroing system, which makes initial sighting in quick and painless.

Set the target to the selected zeroing distance. We recommend 50-100 yards initially. Select a zeroing profile (refer to 2.2.6). You can use different zeroing profiles if you want to use the optic on a different rifles.

Align the reticle with the center of the target and shoot. If the point of impact does not coincide with the aiming point, correct the reticle.

### NOTE:

Zeroing can only be performed at the 50Hz refresh rate. The reticle position and accuracy will remain unchanged when zeroing is complete and switching to 100Hz. Zeroing is not available in 100Hz mode.

1. Hold the MENU button  to bring up the menu.
2. Go to  **Advanced Settings**, rotate the wheel to select  **Zeroing** menu item and press the MENU button  to enter the zeroing setting interface.
3. Rotate the wheel to select  **Zeroing** number you want to correct and press the MENU button  to confirm.

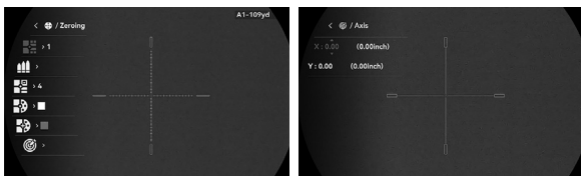















FIGURE 2-8. BORESIGHTING

4. Rotate the wheel to select  **Bullet** and press the MENU button  to set the bullet name for your reticle profiles. Press the MENU button  to select the character to edit, and rotate the wheel to change the character. After you finish entering the bullet name, hold the MENU button  to exit.
5. Rotate the wheel to select  **Correction** and press the MENU button  to enter the boresight correction interface.

Set the distance to the target:

- 1) In the boresight correction interface rotate the wheel to select  **Distance** and press the MENU button  to confirm.
- 2) Press the MENU button  to select the digit you want to change (color of selected digit will be changed to the red).
- 3) Rotate the wheel to change the number.
- 4) Hold the MENU button  to finish the setting.

(Optional) Set the magnification:

- 1) In the boresight correction interface rotate the wheel to select  **Zoom** option and press the MENU button  to confirm.
- 2) Rotate the wheel to enlarge the image until the target positions are clear enough. Press the MENU button  to confirm.



#### **NOTE:**

- We'd suggest zeroing in at 1x digital zoom, or your true 3.5x optical base magnification, or 2x zoom (double your optical magnification) as these options are less pixelated and should provide for easier adjustments.
- 28x magnification available when only zeroing.

6. (Optional) Rotate the wheel to select  **Freeze Screen** option, and press the MENU button to enable the Freeze Screen function.

#### **NOTE:**

When enabling the Freeze Screen function, you can adjust the position of the cursor on a frozen image. This feature helps prevent image flutter and eliminates the need to hold the rifle scope steady in order to make your windage and elevation adjustments on screen.

7. Select  **X/Y Axis** and press the MENU button  to confirm.

Two marks are displayed on the screen. The first mark is the reticle selected in the Zeroing menu. The second, small crosshair is the reference mark. The reference mark is located in the center of the screen. Initially, the centers of both marks are aligned. Zero the scope by moving the reticle on the screen.

- 1) Aim the reticle at the center of target.
- 2) Press the MENU button  to select X or Y axis.
- 3) Rotate the wheel to move reticle left and right (if X axis is selected) or to move reticle up and down (if Y axis is selected).

Holding the reference small crosshair at the aiming point (center of the target) and move the reticle until it is aligned with the point

of impact. The coordinates show the current position of the reticle. It also displays the distance by which the point of impact will move, taking into account the set distance to the target.

TABLE 2-5. BORESIGHT CORRECTIONS

ADJUSTMENT VALUE	RETICLE OFFSET	BORESIGHT INCREMENT
1 click	1 pixel	0.1 mil / 0.34 MOA / 1 cm at 100 m distance / 0.4 in at 100 yd distance







- (Optional) Repeat 3 to 7 to set the position for other reticles in this profile. You can place up to five zeroes at different distances within the same profile (useful for certain calibers with highly fluctuating trajectories between 50 and 250 yards).
- Hold the MENU button  to exit a menu. The window “Save the parameters?” will appear.
  - OK: Save the settings and exit.
  - CANCEL: Exit without saving the settings.

You can also quickly zero your scope using the AGM Connect app:

- Run the application and connect your device via Wi-Fi hotspot as described in Chapter 2.3.
- Select your device in the app menu (  in the upper left corner ).
- Select **Zero** in the **Device Info** section.
- The zeroing interface will appear on the screen of your smartphone. Following the instructions on the screen, make the settings similar to those described above in Paragraph 2.2.8.

## 2.2.9 RETICLE MODE

You can select a reticle mode according to your preferences and different situations.

- Hold the MENU button  to bring up the menu.
- Go to  **Advanced Settings**, rotate the wheel to select  **Zoom** and press the MENU button  to confirm.
- Rotate the wheel to select  **Reticle Mode** and press the MENU button  to enter the setting interface.
- Rotate the wheel to select a reticle mode. Press the MENU button  to confirm.

**Central Reticle:** This mode centers around the image when switching the digital zoom ratio, with the reticle and zoomed image moved to the center of the display.

**Fixed Reticle:** This mode centers around the reticle when switching the digital zoom ratio, with the reticle position unchanged.







5. Hold the MENU button  to save and exit.

#### **NOTE:**

- The digital zoom ratio returns to 1× when switching the reticle mode.
- The beginning zoom ratio in Central reticle mode is about 2× of that in Fixed reticle mode.





### **2.2.10 ZOOM STEP**

You can set the digital zoom step, changing it according to your preferences and different situations.

1. Hold the MENU button  to bring up the menu.
2. Go to  **Advanced Settings**, rotate the wheel to select  **Zoom** and press the MENU button  to confirm.
3. Rotate the wheel to select  **Zoom Step** and press the MENU button  to enter the setting interface.
4. Rotate the wheel to select a zoom step from 0.5x, 1x, 2x, 3x, 4x. Press the MENU button  to confirm.

### **2.2.11 PRERECORD VIDEO**

After enabling the Shot Activated Recording (SAR) function, the device will automatically start recording 5, 10, or 15 seconds before and after the recoil-activation.

1. Hold the MENU button  to bring up the menu.
2. Go to  **Advanced Settings**, rotate the wheel to select  **Prerecord** and press the MENU button  to enter the setting interface.
3. Rotate the wheel to select **OFF** (SAR function disabled) or **5s**, **10s**, or **15s** recording time and press the MENU button  to confirm the selection and exit.





#### **NOTE:**

For exporting recorded files, refer to Export Files (part 2.1.13).

### **2.2.12 FRAME RATE**



This feature allows you to select the refresh rate of the visible light display according to your preference. Higher frame rate enhances image fluidity, particularly useful for fast-moving targets.

1. Hold the MENU button  to bring up the menu.

2. Go to  **Advanced Settings**, rotate the wheel to select  **Frame Rate** and press the MENU button  to confirm.
3. Rotate the wheel to select a frame rate **50FPS** or **100FPS** and press the MENU button  to confirm.





#### **NOTE:**

- When using a frame rate of 100 Hz, the image resolution changes from 4K to 1080P.
- High frame rate mode consumes more power than low frame rate mode.

In live view mode, press and hold the MODE  and MENU  buttons simultaneously to quickly set the frame rate to 50Hz or 100Hz.

### **2.2.13 WDR**

WDR (Wide Dynamic Range) enhances the viewing experience, providing better image quality in diverse lighting conditions. When this feature is enabled, it prevents excessive brightness in light areas and increases shadow detail.





1. Hold the MENU button  to bring up the menu.
2. Go to  **Advanced Settings**, rotate the wheel to select  **WDR menu** and press the MENU button  to confirm.
3. Rotate the wheel to select the WDR function **ON** or **OFF** and press the MENU button  to confirm.

### **2.2.14 DISTANCE MEASUREMENT**

You can detect the distance between the target and the observation position by using the stadiametric rangefinder.

#### **NOTE:**

When measuring the distance, keep your hand and the position steady. Otherwise, the accuracy may be affected.

1. Hold the MENU button  to bring up the menu.
2. Go to  **Advanced Settings**, rotate the wheel to select  **MEASURE** menu item and press the MENU button  to enter the distance measurement interface.
3. Set the parameters for the target.
  - 1) Rotate the wheel to enter the setting interface.
  - 2) Rotate the wheel to select the target from **Deer**, **Grey Wolf**, **Brown Bear**, and **Custom** and press the MENU button  to confirm.

3) Rotate the wheel to set the target height and press the MENU button  to confirm. Each target height preset can be modified from 0.1 to 9.9 m.

4) Hold the MENU button  to save the settings and return to the distance measurement interface.

4. Align the center of the top mark with the top edge of the target and press the MENU button  to confirm. The top mark blinks and then changes to the bottom mark.

5. Align the center of the bottom mark with the bottom edge of the target and press the MENU button  to confirm. The bottom mark blinks and then disappears.

The right top of the image displays the height of the target and the distance measurement result. You can select the unit of measurement (see section 2.2.26).





FIGURE 2-10. DISTANCE MEASUREMENT

## 2.2.15 AUTO SCREEN OFF

Auto Screen Off function darkens the screen to save energy and increase battery time. However, the device stays on and you can view the live view on AGM Connect app when connecting the device to the app.

1. Hold the MENU button  to bring up the menu.

2. Go to  **Advanced Settings** and rotate the wheel to select  **Auto Screen Off**.

3. Press the MENU button  to enable or disable the Auto Screen Off function.

You can do one of the following methods to enter the standby mode when the display is turned on:





- Tilt the device downwards more than 70°.
- Rotate the device horizontally more than 45°.
- Keep the device still and do not move it for 5 minutes.

You can do one of the following methods to wake up the device when the display is turned off:

- Tilt the device downwards from 0° to 60° or upwards .
- Rotate the device horizontally from 0° to 40°.
- Press  to wake up the device.





### 2.2.16 AUDIO RECORDING

The Audio function allows you to record sound along with video. If there is too much noise when recording, this function can be disabled.

1. Hold the MENU button  to bring up the menu.
2. Go to  **Advanced Settings** and rotate the wheel to select  **Audio**.
3. Press the MENU button  to enable or disable Audio function.

### 2.2.17 SMART IR







If the environment is too bright, the image may be overexposed . The smart IR function helps correct overexposed images by controlling the intensity of infrared light to improve the image in night mode and dark environment.

1. Hold the MENU button  to bring up the menu.
2. Go to  **Advanced Settings** and rotate the wheel to select  **Smart IR**.
3. Press the MENU button  to enable or disable the Smart IR function.

### 2.2.18 ON-SCREEN DISPLAY (OSD)







You can choose which information to display in the live view user interface. OSD options include Day/Night mode, Wi-Fi Hotspot, Battery Status, and Current Magnification indicators. You can also enable or disable the display of time and date on the screen. These will appear at the left side of the display when activated.

1. Hold the MENU button  to bring up the menu.

2. Go to  **Advanced Settings**, rotate the wheel to select  **Function Settings** and press the MENU button  to confirm.
3. Rotate the wheel to select  **OSD** OSD submenu and press the MENU button  to enter.
4. Rotate the wheel to select the **OSD, Time, or Date**. Press the MENU button  to display or hide the necessary information.
5. Hold the MENU button  to exit a menu.







### 2.2.19 SET PITCH SCALE

You can enable pitch scale to view the device inclination angle in the live view.

1. Hold the MENU button  to bring up the menu.
2. Go to  **Advanced Settings**, rotate the wheel to select  **Function Settings** and press the MENU button  to confirm.
3. Rotate the wheel to select  **Pitch Scale** and press the wheel to enable or disable the pitch scale.
4. Hold the MENU button  to exit the menu.







### 2.2.20 BRAND LOGO

You can display the AGM logo in the lower left corner of the screen.

1. Hold the MENU button  to bring up the menu.
2. Go to  **Advanced Settings**, rotate the wheel to select  **Function Settings** and press the MENU button  to confirm.
3. Rotate the wheel to select  **Brand Logo** menu item. Press the MENU button  to enable/disable logo.
4. Rotate the wheel to select to select other item or hold the MENU button  to exit.

### 2.2.21 USB CONNECTION







The USB port can be used to transfer data to a PC, charge the installed batteries, or casting screen to PC by UVC protocol-based client software or player. You can view the device screen image on the monitor to get a better and clearer image, more convenient to checking the details.

1. Hold the MENU button  to bring up the menu.
2. Go to  **Advanced Settings**, rotate the wheel to select  **Function Settings** and press the MENU button  to confirm.
3. Rotate the wheel to select  **USB Flash Drive** menu item and press the MENU button  to enter the configuration interface.

4. Rotate the wheel to select **USB Flash Drive** for transfer data or charge the battery, or **Digital** to casting screen to PC.
5. Press the MENU button  to confirm and exit.







### 2.2.22 LANGUAGE SETTING

You can select different languages of user interface.

1. Hold the MENU button  to bring up the menu.
2. Go to  **Advanced Settings**, rotate the wheel to select  **General Settings** and press the MENU button  to confirm.
3. Rotate the wheel to select  **Language** submenu and press the MENU button  to enter.
4. Rotate the wheel to select the language as required and press the MENU button  to confirm.







### 2.2.23 DISPLAY INTERFACE SHAPE



You can switch between the **Circular** and **Rectangular** display interface shape.

1. Hold the MENU button  to bring up the menu.
2. Go to  **Advanced Settings**, rotate the wheel to select  **General Settings** and press the MENU button  to confirm.
3. Rotate the wheel to select  **Display Interface Shape** menu item and press the MENU button  to confirm.
4. Rotate the wheel to select **Circular** and **Rectangular** display interface shape and press the MENU button  to confirm.
5. The window **"Save all parameters and exit? The image will be displayed in current style."** will appear.
  - **OK**: Display interface shape will change.
  - **CANCEL**: Exit without changing the settings.









Rotate the wheel to select to select an option, and then press the MENU button  to confirm.

### 2.2.24 TIME SETTING

1. Hold the MENU button  to bring up the menu.
2. Go to  **Advanced Settings**, rotate the wheel to select  **General Settings** and press the MENU button  to confirm.
3. Rotate the wheel to select  **Time** and press the MENU button  to enter the configuration interface.









4. Press the MENU button  to select the time format (12/24), hours or minutes to sync and rotate the wheel to change the number.
5. Hold the MENU button  to exit the menu.

### 2.2.25 DATE SETTING

1. Hold the MENU button  to bring up the menu.
2. Go to  **Advanced Settings**, rotate the wheel to select  **General Settings** and press the MENU button  to confirm.
3. Rotate the wheel to select  **Date** submenu and press the MENU button  to enter the configuration interface.
4. Press the MENU button  to select the month, day or year to be synchronized and rotate the wheel to change the number.
5. Hold the MENU button  to exit the menu.







### 2.2.26 UNIT SETTING

You can set the unit of measurement (yards or meters) for the distance.

1. Hold the MENU button  to bring up the menu.
2. Go to  **Advanced Settings**, rotate the wheel to select  **General Settings** and press the MENU button  to confirm.
3. Rotate the wheel to select  **Unit** and press the MENU button  to enter the configuration interface.
4. Rotate the MENU button  to select **yd** (yards) or **m** (meters) and press the MENU button  to confirm.

### 2.2.27 AUTO POWER OFF







You can set the time for the automatic shutdown of the device as required.

1. Hold the MENU button  to bring up the menu.
2. Go to  **Advanced Settings**, rotate the wheel to select  **General Settings** and press the MENU button  to confirm.
3. Rotate the wheel to select  **Auto Power Off** and press the MENU button  to enter the configuration interface.
4. Rotate the wheel to select **OFF**, **15 min**, **30 min** or **45 min** and press the MENU button  to confirm.

The Auto Power Off countdown will start again when the device exits standby mode, or the device is restarted.







## 2.2.28 REBOOT DEVICE

You can reset all the basic settings (Brightness, Contrast, etc.) to default values.

1. Hold the MENU button  to bring up the menu.
2. Go to  **Advanced Settings**, rotate the wheel to select  **General Settings** and press the MENU button  to confirm.
3. Rotate the wheel to select  **Reboot** and press the MENU button . The window “Reset the basic settings” will appear.
  - **OK**: Restore the settings to defaults.
  - **CANCEL**: Exit without changing the settings.







## 2.2.29 RESTORE FACTORY SETTINGS

You can reset all device settings, zeroing settings and delete all contents of the built-in storage.

1. Hold the MENU button  to bring up the menu.
2. Go to  **Advanced Settings**, rotate the wheel to select  **General Settings** and press the MENU button  to confirm.
3. Rotate the wheel to select  **Restore Factory Settings** and press the MENU button . The window “Erase all content and settings” will appear.
  - **OK**: Erase all content and reset all settings to defaults.
  - **CANCEL**: Exit without changing the settings.

## 2.2.30 VERSION

You can view the device information such as firmware version, serial number and free space of built-in storage.

1. Hold the MENU button  to bring up the menu.
2. Go to  **Advanced Settings**, rotate the wheel to select  **General Settings** and press the MENU button  to confirm.
3. Rotate the wheel to select  **Version** and press the MENU button  to confirm. The firmware version, serial number and memory capacity will be displayed.
4. Hold the MENU button  to exit the menu.

## 2.3 CLIENT SOFTWARE INTRODUCTION



Search the AGM Connect software in App Store (iOS System) or Google Play™ (Android System) and install the application on your mobile phone. Turn on the Wi-Fi hotspot on the Spectrum 4K-Mini and then connect your phone to the hotspot.

- Hotspot Name: Wlan-<Serial No.>

- Hotspot Password: Last 9 digits of Serial Number of your scope.

### NOTE:

The device password is set by user at first activation. If the password was lost or forgotten, it can be reset. To make a reset, provide the following action:

1. Hold the MENU button  to show the menu of device.
2. Move the cursor to  menu item and press the MENU button  to restore all parameters to default settings.

1. Run the app and connect the phone or tablet with the device.
2. If the device is inactivated, set the password and activate it. If the device is activated, enter the password to add it to the app.
3. When the device is added, the live view can be seen. You can view the interface of the rifle scope on the software. User can change such image parameters as brightness, contrast, zoom, palettes directly via phone or tablet as well as record video on phone/tablet memory.

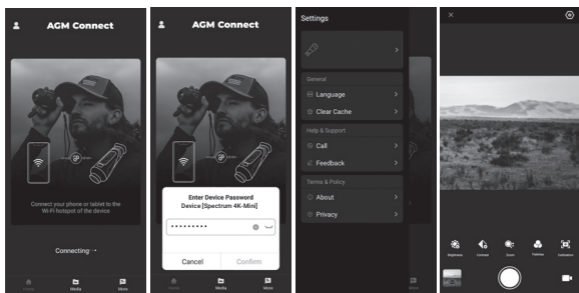

FIGURE 2-9. AGM CONNECT APP

# 3 MAINTENANCE

## 3.1 MAINTENANCE

### 3.1.1 CLEANING PROCEDURES

1. Gently brush off any dirt from the body of the device using a clean, soft cloth.
2. Moisten the cloth with fresh water and gently wipe down the external surfaces (except lenses).
3. Dry any wet surfaces (except lenses) using another dry, clean, soft cloth.
4. Using a lens brush, carefully remove all loose dirt from the lenses.
5. Dampen a cotton swab with ethanol and slowly, gently wipe down the lenses. Clean the glass surfaces using circular movements, starting from the center of the lens and moving out towards the edge, without touching the lens holder. Change the cotton swab after each circular stroke. Repeat this step until the glass surfaces are clean.
6. Clean the accessories with a soft brush (or cloth) dampened with soap and water.

### 3.1.2 PREPARING FOR EXTENDED STORAGE

#### **CAUTION:**

Thoroughly dry each item before placing them into the storage case.

To prepare the rifle scope for extended storage:

1. Clean the rifle scope and accessories.
2. Place all items into the storage case.

### 3.1.3 UPDATING THE DEVICE FIRMWARE

1. Visit [www.agmglobalvision.com/firmware](http://www.agmglobalvision.com/firmware) website. Select your product, download the firmware update package to your PC and unzip it. Follow the detailed instructions on the website.
2. Connect the device to your PC with USB cable.
3. Turn on the device. Make sure the Wi-Fi hotspot function is disabled.
4. Open the detected disk (USB drive) in file manager program. Copy the unzipped digicap.dav file and paste it to the root directory of the device.
5. Turn off the device completely, then power it back on. After awhile, the firmware update process will start automatically. During the update, the screen will display the inscription "Upgrading...". The update process will be completed when the inscription "Upgrading..." goes out.
6. Turn off the device and disconnect it from your PC.

You can also enjoy automatic update function in AGM Connect App (see section 2.3 for details):

1. Start the AGM Connect App and tap the Settings icon in the left top corner.
2. Tap your device in the device list. The information about your device will shown.
3. Tap **Checking for Upgrade** to detect and download the latest FW version.

## 3.2 TROUBLESHOOTING

Table 3-1 lists the most common malfunctions that may occur with your equipment. Perform the tests, inspections, and corrective actions in the order they appear in the table.

This table does not list all the malfunctions that may occur with your device, or all of the tests, inspections, and corrective actions that may be necessary to fix them. If the equipment malfunction is not corrected by the suggested actions, or a problem occurs that is not listed in this table, please contact AGM Global Vision's Customer Support center or your retailer.

TABLE 3-1. TROUBLESHOOTING

MALFUNCTION	CORRECTIVE ACTION
The rifle scope fails to activate.	Charge the inner battery of the scope or install the charged additional 18650 battery.
The image of the rifle scope is not clear.	Perform the rifle scope adjustment referring to section 2.1.
Wi-Fi is not found.	Examine whether the Wi-Fi function is turned on. If not, go to menu and turn on Wi-Fi Hotspot.
Capturing or recording fails.	Examine the items below: 1. Whether the device is connected to your PC and disabled the capturing and recording. 2. Whether the storage space is full. 3. Whether the device is low-battery.
The PC cannot identify the rifle scope.	Examine the items below: 1. Whether the device is connected to your PC with standard USB cable. 2. If you use other USB cables, make sure the cable length is no longer than 1 m.

## 4 WARRANTY INFORMATION

### 4.1 WARRANTY INFORMATION AND REGISTRATION

The below description of AGM Global Vision warranty terms and conditions refer specifically to AGM branded products purchased within the United States. Customers purchasing AGM products outside the United States can obtain specific information about their product's warranty term on the [www.agmglobalvision.eu](http://www.agmglobalvision.eu) website.

#### 4.1.1 WARRANTY INFORMATION

This product is guaranteed to be free from manufacturing defects in material and workmanship under normal use for a period of **three (3) years** from the date of purchase. In the event that a defect covered by the warranty below occurs during the applicable period stated above, AGM Global Vision, at its discretion, will either repair or replace the product; such action on the part of AGM Global Vision shall be the full extent of AGM Global Vision's liability, and the Customer's sole and exclusive reparation. This warranty does not cover a product if it has been (a) used in ways other than its normal and customary manner; (b) subjected to misuse; (c) subjected to alterations, modifications or repairs by the Customer or by any party other than AGM Global Vision without prior written consent of AGM Global Vision; (d) is the result of a special order or categorized as "close-out" merchandise or merchandise sold "as-is" by either AGM Global Vision or the AGM Global Vision dealer; or (e) merchandise that has been discontinued by the manufacturer and either parts or replacement units are not available due to reasons beyond the control of AGM Global Vision. AGM Global Vision shall not be responsible for any defects or damage that in AGM Global Vision's view are a result from the mishandling, abuse, misuse, improper storage or improper operation of the device, including use in conjunction with equipment that is electrically or mechanically incompatible with, or of inferior quality to, the product, as well

as failure to maintain the environmental conditions specified by the manufacturer. This warranty is extended only to the original purchaser. Any breach of this warranty shall be enforced unless the customer notifies AGM Global Vision at the address noted below within the applicable warranty period.

The customer understands and agrees that except for the foregoing warranty, no other warranties written or oral, statutory, expressed or implied, including any implied warranty of merchantability or fitness for a particular purpose, shall apply to the product. All such implied warranties are hereby and expressly disclaimed.

#### **4.1.2 LIMITATION OF LIABILITY**

AGM Global Vision will not be liable for any claims, actions, suits, proceedings, costs, expenses, damages, or liabilities arising out of the use of this product. Operation and use of the product are the sole responsibility of the Customer. AGM Global Vision's sole undertaking is limited to providing the products and services outlined herein in accordance with the terms and conditions of this Agreement. The provision of products sold and services performed by AGM Global Vision to the Customer shall not be interpreted, construed, or regarded, either expressly or implied, as being for the benefit of or creating any obligation toward any third party of legal entity outside AGM Global Vision and the Customer; AGM Global Vision's obligations under this Agreement extend solely to the Customer. AGM Global Vision's liability hereunder for damages, regardless of the form or action, shall not exceed the fees or other charges paid to AGM Global Vision by the customer or customer's dealer. AGM Global Vision shall not, in any event, be liable for special, indirect, incidental, or consequential damages, including, but not limited to, lost income, lost revenue, or lost profit, whether such damages were foreseeable or not at the time of purchase, and whether or not such damages arise out of a breach of warranty, a breach of agreement, negligence, strict liability, or any other theory of liability.

#### **4.1.3 PRODUCT REGISTRATION**

In order to validate the warranty on your product, the customer must complete and submit AGM Global Vision PRODUCT REGISTRATION FORM on our website ([www.agmglobalvision.com/customer-support](http://www.agmglobalvision.com/customer-support)).

#### **4.1.4 OBTAINING WARRANTY SERVICE**

To obtain warranty service on your unit, the End-user (Customer) must notify the AGM Global Vision service department via e-mail.

Send any requests to [support@agmglobalvision.com](mailto:support@agmglobalvision.com) to receive a Return Merchandise Authorization number (RMA). When returning any device, please take the product to your retailer, or send the product, postage paid and with a copy of your sales receipt, to AGM Global Vision's service center at the address listed above. All merchandise must be fully insured with the correct postage; AGM Global Vision will not be responsible for improper postage or merchandise that becomes lost or damaged during shipment. When sending product back, please clearly write the RMA# on the outside of the shipping box. Please include a letter that indicates your RMA#, the Customer's Name, a Return Address, reason for the return, contact information (valid telephone numbers and/or an e-mail address), and proof of purchase that will help us to establish the valid start date of the warranty. Product merchandise returns that do not have an RMA# listed may be refused, or a significant delay in processing may occur. Estimated Warranty service time is 10-20 business days. The End-user/Customer is responsible for postage to AGM Global Vision for warranty service. AGM Global Vision will cover return postage/shipping after warranty repair to the End-user/Customer only if the product is covered by the aforementioned warranty. AGM Global Vision will return the product after warranty service by domestic UPS Ground service and/or domestic mail. Should any other requested, required, or international shipping methods be necessary, the postage/shipping fee will be the responsibility of the End-user/Customer.

For service, repair or replacement, please contact:

### **AGM Global Vision, LLC**

**2407 E Interstate 30, Suite 100**

**Grand Prairie, TX 75050**

**Tel. 928.333.4300**

**[support@agmglobalvision.com](mailto:support@agmglobalvision.com)**

**[www.agmglobalvision.com](http://www.agmglobalvision.com)**

# 5 SPECIFICATIONS

## 5.1 SPECIFICATIONS

MAIN	
Sensor Type	CMOS
Max. Resolution	3840 × 2160
Frame Rate	50Hz (4K), 100Hz (1080P)
Magnification	3.5x - 20.5x
Lens Focal Length	40 mm, F2.0
Field of View	Rectangular display : 10.7° × 6.1° / 18.7m×10.1m @100m Circular display : 10° × 6.1° / 17.5m×10.1m @100m
Minimal Focusing Distance	2 m
Detection Range	800 m at Daytime
Display	0.49" OLED display, 1920×1080
Exit Pupil	6 mm
Eye Relief	45 mm
Diopter Adjustment	-5 to +5
SYSTEM	
Image Mode	Day, Night, Auto, Green, Yellow
Digital Zoom	Support continuous zoom with step 0.5x, 1x, 2x, 3x, 4x
Picture-in-Picture Mode (PIP)	Yes
Reticle	10 reticle patterns, 8 colors
Video Recording	Yes (1920×1080)

Audio Recording	Yes
Shot-Activated Recording	Yes
Image Capture	Yes (1920×1080)
Storage	32 GB Built-in EMMC
Standby Mode	Yes
Freeze Zeroing	Yes
Zeroing Profiles	5
Wi-Fi Hotspot	Yes
<b>POWER SUPPLY</b>	
Battery Type	Built-in rechargeable Li-Ion battery and one additional replaceable rechargeable 18650 battery
Battery Life	Up to 7.8 hours of continuous operation (25°C, Wi-Fi off)
External Power Supply	5 VDC/2 A, USB Type-C Interface Only internal battery support direct charge
<b>GENERAL</b>	
Working Temperature	-30°C to 55°C (-22°F to 131°F)
Max. Recoil	1000 g / 0.4 ms
Mounting	Standard 30 mm
Dimensions	331 × 86 × 67 mm / 13 × 3.4 × 2.5 in (without mount)
Weight	0.45 kg / 1.0 lb (without mount and external battery)
Protection Level	IP67

*\*All data subject to change without notice.*

## 5.2 RETICLE PARAMETERS

IMAGE	ITEM	MOA	CM @ 100M	IN @ 100YD
<b>RETICLE 1</b>				
	A	101.1	294.0	105.8
	B	21.0	61.0	22.0
	C	6.5	19.0	6.8
	D	1.0	3.0	1.1
<b>RETICLE 2</b>				
	A	122.7	357.0	128.5
	B	113.1	329.0	118.4
	C	1.0	3.0	1.1
<b>RETICLE 3</b>				
	A	122.7	357.0	128.5
	B	113.1	329.0	118.4
	C	1.0	3.0	1.1

IMAGE	ITEM	MOA	CM @ 100M	IN @ 100YD
<b>RETICLE 4</b>				
	A	85.9	250.0	90.0
	B	85.9	250.0	90.0
	C	23.4	68.0	24.5
	D	4.5	13.0	4.7
	E	28.2	82.0	29.5
	F	2.4	7.0	2.5
	G	3.4	9.8	3.5
	H	3.4	9.8	3.5
	I	1.0	3.0	1.1
	J	4.1	12.0	4.3
	K	2.8	8.0	2.9
<b>RETICLE 5</b>				
	A	3.1	9.0	3.2
	B	3.8	11.0	4.0
	C	3.1	9.0	3.2
<b>RETICLE 6</b>				
	A	5.5	16.0	5.8
	B	1.7	5.0	1.8

IMAGE	ITEM	MOA	CM @ 100M	IN @ 100YD
<b>RETICLE 7</b>				
	A	122.0	355.0	127.8
	B	99.0	288.0	103.7
	C	23.7	69.0	24.8
	D	3.1	9.0	3.2
	E	1.0	3.0	1.1
	F	2.8	8.0	2.9
	G	4.1	12.0	4.3
	H	3.4	10.0	3.6
	I	5.3	15.3	5.5
	J	8.0	23.3	8.4
	<b>RETICLE 8</b>			
	A	109.0	317.0	114.1
	B	29.2	85.0	30.6
	C	1.0	3.0	1.1
<b>RETICLE 9</b>				
	A	2.4	7.0	2.5
	B	29.2	85.0	30.6
	C	1.0	3.0	1.1
<b>RETICLE 10</b>				
	A	5.2	15.0	5.4

\* All reticle parameters are indicated for 1x magnification.

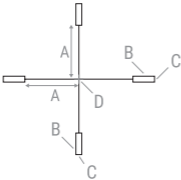
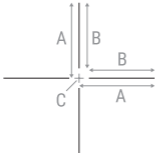
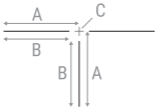

## **AGM Global Vision, LLC**

### **MAIN OFFICE**

2407 E Interstate 30,

Suite 100

Grand Prairie, TX 75050

USA

Tel. +1.928.333.4300

[info@agmglobalvision.com](mailto:info@agmglobalvision.com)

[www.agmglobalvision.com](http://www.agmglobalvision.com)

### **EUROPEAN OFFICE**

#6 Andrey Lyapchev Blvd

Sofia, P.C. 1756

Bulgaria

Tel. +35.988.560.0326

[info@agmglobalvision.eu](mailto:info@agmglobalvision.eu)

[www.agmglobalvision.eu](http://www.agmglobalvision.eu)

### **DOWNLOAD AGM CONNECT APP:**



Google Play Store



Apple App Store

[AGMglobalvision.com](http://AGMglobalvision.com)