

ADDER V² LRF

THERMAL IMAGING RIFLE SCOPE
WITH LASER RANGEFINDER

USER MANUAL

© 2025 AGM Global Vision, LLC. All rights reserved.

This documentation is subject to change without notice.

No parts of this manual, in whole or in part, may be copied, photocopied, translated, or transmitted by any electronic medium or in machine-readable form without the prior written permission of AGM Global Vision, LLC.

If you have questions that are not covered in this manual, or need service, contact AGM Global Vision customer support for additional information prior to returning a product.

AGM Global Vision, LLC

2407 E Interstate 30, Suite 100

Grand Prairie, TX 75050, USA

Tel. 928.333.4300

support@agmglobalvision.com

www.agmglobalvision.com

EXPORT INFORMATION

Buyer acknowledges that all products supplied by AGM Global Vision, LLC are subject to U.S. export control laws, including, but not limited to, the Export Administration Regulations, the International Economic Emergency Powers Act, and various U.S. embargoes and sanctions. AGM Global Vision products may not be exported, re-exported, or transferred contrary to U.S. export control laws. In particular, AGM Global Vision products may not be exported, re-exported, or transferred to prohibited countries, individuals, organizations, or entities, including but not limited to those individuals and entities listed on the List of Specially Designated Nationals and Blocked Persons administered or maintained by the U.S. Office of Foreign Assets Control ("OFAC"), the various lists maintained by the Bureau of Industry and Security of the Department of Commerce, and the U.S. State Department and Buyer represents and warrants that neither Buyer nor any of its officers, directors, or employees are on such lists. Distribution or resale by Buyer to such countries, individuals, organizations, or entities is expressly prohibited. Buyer has and will maintain a positive process to ensure compliance with this Section.

FCC INFORMATION

Please take attention that changes or modification not expressly approved by the party responsible for compliance could void the user's authority to operate the equipment.



This equipment complies with FCC/IC RSS-102 radiation exposure limits set forth for an uncontrolled environment.

FCC compliance: This product has been tested and found to comply with the limits for a Class B digital device, pursuant to Part 15 of the FCC Rules. These limits are designed to provide reasonable protection against harmful interference in a residential installation. This product generates, uses, and can radiate radio frequency energy and, if not installed and used in accordance with the instructions, may cause harmful interference to radio communications. However, there is no guarantee that interference will not occur in a particular installation. If this product does cause harmful interference to radio or television reception, which can be determined by turning the equipment off and on, the user is encouraged to try to correct the interference by one or more of the following measures:

- Reorient or relocate the receiving antenna.
- Increase the separation between the equipment and receiver.
- Connect the equipment into an outlet on a circuit different from that to which the receiver is connected.
- Consult the dealer or an experienced radio/TV technician for help.

FCC Conditions

This device complies with part 15 of the FCC Rules. Operation is subject to the following two conditions:

1. This device may not cause harmful interference.
2. This device must accept any interference received, including interference that may cause undesired operation.

EU CONFORMITY STATEMENT



This product and - if applicable - the supplied accessories too are marked with "CE" and comply therefore with the applicable harmonized European standards listed under the EMC Directive 2014/30/EU, the RoHS Directive 2011/65/EU



2012/19/EU (WEEE directive): Products marked with this symbol cannot be disposed of as unsorted municipal waste in the European Union. For proper recycling, return this product to your local supplier upon the purchase of equivalent new equipment, or dispose of it at designated collection points. For more information see: www.recyclethis.info



Regulation (EU) 2023/1542 (Battery Regulation): This product contains a battery and it is in conformity with the Regulation (EU) 2023/1542. The battery cannot be disposed of as unsorted municipal waste in the European Union. See the product documentation for specific battery information. The battery is marked with this symbol, which may include lettering to indicate cadmium (Cd), or lead (Pb). For proper recycling, return the battery to your supplier or to a designated collection point. For more information see: www.recyclethis.info.

LIST OF CONTENTS

TITLE	PAGE
Safety Summary	6
1. GENERAL INFORMATION	8
1.1 System Description	8
1.2 Standard Components	9
1.3 Key Features	12
2. OPERATING INSTRUCTIONS	13
2.1 Basic Operations	13
2.2 Main Function	22
2.3 Client Software Introduction	46
3. MAINTENANCE	47
3.1 Maintenance	47
3.2 Troubleshooting	49
4. WARRANTY INFORMATION	50
4.1 Warranty Information and Registration	50
5. SPECIFICATIONS	53
5.1 Specifications	53
5.2 Reticle Parameters	59

SAFETY SUMMARY

- Read and follow all instructions
- Read all warnings
- Only use the attachments/accessories specified by the manufacturer
- All service must be provided by the manufacturer

WARNINGS:

This product contains natural rubber latex, which may have the potential to cause allergic reactions. If you are allergic to latex, it is important that you strictly avoid exposure to products that contain it.

- Always make sure your firearm is unloaded before you place the optic on the firearm. Reconfirm that the chamber is empty if you are forced to stop at anytime before completing the zeroing in process. Safe handling rules should be followed at all times.
- If a scope is mounted too far to the rear, the eyepiece may cause an impact injury to the shooter's eye socket. Shooting at an uphill angle also increases this hazard because it shortens the distance between the eyebrow and the rear of the scope. For this reason, AGM scopes are engineered to provide generous eye relief. Therefore, when mounting your scope, we recommend positioning it as far forward in the mounts as possible to take full advantage of this generous eye relief. With hard-recoiling rifles, serious injury or even death can result from eyepiece impact with the shooter during the recoil process when discharging the firearm. Be certain that your installation provides sufficient eye relief for the recoil generated by your rifle before shooting the firearm.

NOTES:

Give special attention to this warning when shooting uphill and/or from a prone position. These shooting conditions can dramatically reduce eye relief. PLEASE maintain maximum eye relief when shooting heavy recoiling and/or magnum firearms. THE USER ASSUMES ALL RESPONSIBILITY AND LIABILITY FOR HAVING THE AGM RIFLE SCOPE PROPERLY MOUNTED TO A FIREARM AND USING THE AGM RIFLE SCOPE PROPERLY. ALWAYS CHECK THE CONDITION OF YOUR MOUNTING SYSTEM PRIOR TO USING YOUR FIREARM.

- Proper usage of the device is crucial for safe operation, so make sure to carefully read this manual.
- If the device was left in storage for a longer period of time, before use, check its functionality.
- Disassembling of the device is prohibited and will invalidate the product warranty. Disassembly of any kind should only occur at AGM repair facilities.
- The external optical surfaces should be clean at all times. Touching the optical surfaces with bare hands is not recommended.
- Sand and sea water can damage the optical coatings.
- Do not point the device directly at the sun as it may damage the display.
- Thermal imagery is highly dependent on different scenery and atmospheric conditions. The same scenery may differ slightly in its appearance to the user, based on the time of day or night the optic is being used. This is the result of the level of heat absorption of different objects, which will vary based on the sun's placement in the sky at the time of use. The contrast of live animals will be more evident depending on the difference in surrounding air temperature and humidity levels.
- It is always recommended to store the unit with battery removed, when not in use. Recharging the batteries every 2-3 months will help to extend their charging reliability.
- It is recommended to store the device with the lens cap closed at all times.
- Occasionally, extreme temperature shifts may cause condensation to form on the outer germanium lens. In this scenario, use a soft cloth to gently wipe the lens clean. As the unit becomes acclimates to the outer temperature, condensation should dissipate.

NOTES:

- The detector spectral band provides better visibility through smoke, dust, rain, smog, etc.
- Infrared radiation does not travel through glass. As a result, the rifle scope does not detect objects if they are behind glass windows or other barriers.

LASER CAUTION:

When any laser equipment is in use, make sure that the device lens is not exposed to the laser beam, or it may burn out. The laser radiation emitted from the device can cause eye injuries, burning of skin or inflammable substances. Before enabling the light supplement function, make sure no human or inflammable substances are in front of the laser lens. Do not place the device where minors can fetch it. According to IEC 60825 1:2014, EN 60825 1:2014+A11:2021, and EN 50689:2021, this laser product is classified as Class 1 laser product and consumer laser product.

Complies with FDA performance standards for laser products except for conformance with IEC 60825-1 Ed. 3., as described in Laser Notice No.56, dated May 8, 2019.

CONSUMER LASER PRODUCT
CLASS 1 LASER PRODUCT
EN 60825-1:2014+A11:2021
IEC 60825-1:2014
EN 50689:2021



1 GENERAL INFORMATION

1.1 SYSTEM DESCRIPTION

The AGM AdderV² LRF thermal rifle scopes pack all the technology and advanced electronics into the historically familiar 30 mm tube rifle scope housing. The AdderV² LRF pairs a 35 mm, 50 mm or 60 mm Germanium lens with an upgraded sub-15 mK thermal detector with 384×288 and 640×512 resolution and sub-18mK detector with 1280×1024 resolution. Not only that, but it's been paired with a fully integrated 1,000 m laser rangefinder and AGM's new on-board ballistic calculator.

AdderV² feature a 1.03-inch AMOLED display with a resolution of 2560×2560, providing one of the best images AGM has produced to date. Unlike smaller lenses with larger microns, AGM 12-micron sensors allows predator hunters to start at a higher base magnification, which eliminates the inevitable degradation of the resolution that is required for low base magnification units.

AdderV² supports shutterless technology (except for the 1280 model). This dynamic learning process without image quality loss eliminates the need for periodic calibration pauses. Now you will never miss a critical moment in the field. Other enhancements include an impressive 9 hours of battery life on two internal 18650 rechargeable batteries, and shot-activated video recording, which, when enabled, ensure that hunters forgetting to press the record button is a thing of the past!

The entire AdderV² LRF product family also comes with a high-quality 30 mm mount that allows for sliding the scope both forward and backwards to provide optimal eye relief for shooters using a wide array of different shooting platforms. Other features include, but aren't limited to: 50 Hz refresh rate, IP67 waterproof rating, external power capability, 64 GB of on-board memory, different reticle options, WiFi and AGM Connect app compatibility, multiple color palettes, audio recording.

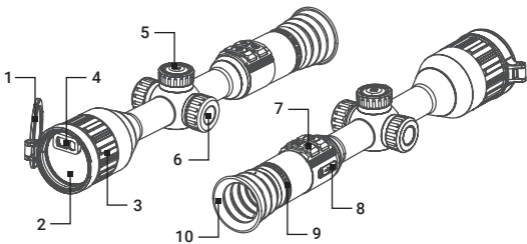

FIGURE 1-1. MAIN PARTS

TABLE 1-1. MAIN PARTS

ITEM	DESCRIPTION
1	Lens Cover
2	Lens
3	Focus Ring
4	Laser Rangefinder
5	Navigation Wheel
6	Battery Cover
7	Operating Buttons
8	USB Interface Cover
9	Diopter Adjustment Ring
10	Eyecup

1.2 STANDARD COMPONENTS

The standard components are shown in Figure 1-2 and listed in Table 1-2.

The ITEM column indicates the number used to identify items in Figure 1-2.

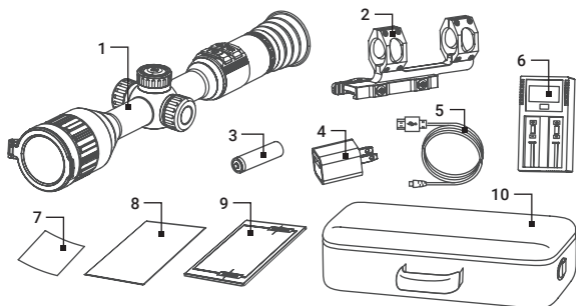

FIGURE 1-2. STANDARD COMPONENTS

TABLE 1-2. STANDARD COMPONENTS

ITEM	DESCRIPTION	QUANTITY
1	Rifle Scope	1
2	Quick Release Mount	1
3	18650 Rechargeable Battery	2
4	Power Adapter	1
5	Type-C USB Cable	1
6	18650 Battery Charger	1
7	Lens Cloth	1
8	Quick Start Guide	1
9	User Manual	1
10	Carrying Case	1

* Standard components may vary depending on the region of sale.

1.3 KEY FEATURES

- 384×288, 640×512 or 1280×1024 thermal resolution
- Sub-15 mK thermal sensitivity for models 384 and 640, sub-18 mK for 1280 model
- 12 micron detector
- Improved Image Boost 3.0 algorithm with reduced noise and enhanced target highlighting
- Fast 50 Hz imaging
- 2560×2560 resolution 1.03-inch AMOLED display
- Shutterless technology (except model 1280)
- Built-in 1000 m laser rangefinder
- Internal ballistic calculator
- Selectable 2X, 4X, 8X digital zoom or continuous zoom in 0.5x increments
- Various reticle types and colors
- Adjustable color palettes
- On-board video/audio recording and image capture
- UVC screen casting via USB Type-C interface
- Shot Activated Recording (SAR)
- Fast 64GB EMMC built-in storage
- WiFi data transmission
- AGM Connect App compatibility
- Standby mode
- Dual power system with rechargeable internal battery and additional replaceable and rechargeable battery
- 9 hours of battery life
- External power supply capability
- High shock resistance up to 1000 g / 0.4 ms
- Waterproof & shockproof

2 OPERATING INSTRUCTIONS



2.1 BASIC OPERATIONS

2.1.1 UNPACKING

The following steps must be completed prior to each mission.

1. Open the carrying case, remove the device, and verify that all components are included.
2. Inspect the device for any obvious evidence of damage to the optical surfaces, body, eyecup, operation buttons, etc. Ensure that all optical surfaces are clean and ready for use. Clean all optical surfaces with a lens tissue.

2.1.2 CHARGING THE BUILT-IN BATTERY

When the device is turned on, the battery indicator on the screen shows the built-in battery status. Icon  means the internal battery is fully charged, icon  means that the battery is low.

When the low power note shows, charge the battery.

NOTE:

Charge the battery with the included USB cable and power adapter. The charging temperature should be 0°C to 45°C (32°F to 113°F).

1. Open the USB interface cover (Figure 2-1, A).
2. Connect the power adapter to the scope's interface port (B) using the USB cable (C).

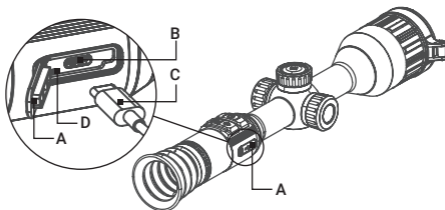

FIGURE 2-1. USB INTERFACE



3. Plug in the power adapter and charge the built-in battery. Icon  in the FOV of scope indicates the charging process. The green icon  means the battery is fully charged. The color LED (D) near USB port indicates the charging status. Charge the device for more than 6 hours before first use.

TABLE 2-1. CHARGING STATUS INDICATION

INDICATOR	FUNCTIONS
Flashing Red & Green	Error occurred.
Solid Red	Battery is properly charging.
Solid Green	Battery is fully charged.
Off	Battery is not charged.

2.1.3 ADDITIONAL 18650 BATTERY INSTALLATION

1. Turn the battery cover (Figure 2-2, A) counterclockwise to open it.
2. Insert 18650 rechargeable battery (B) into the battery compartment (C) with the positive mark inward.
3. Turn the battery cover clockwise to tighten it.

The battery icon  on the screen indicates the status of the additional (External) battery. Charge the 18650 battery using the included battery charger.

The green arrow above the battery icon  shows which battery is currently being used.

NOTE:

Remove the additional battery from the battery compartment if the device is not used for a long time.

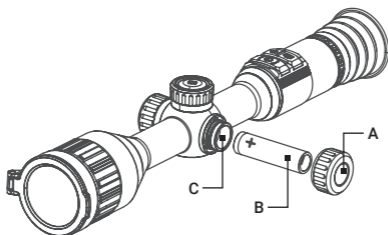

FIGURE 2-2. ADDITIONAL BATTERY INSTALLATION

2.1.4 CONTROL BUTTONS

The AdderV² LRF controls are shown in Figures 2-3 and are defined in Tables 2-2.

Each button is responsible for some functions selected by short press or long press (hold) the button. Pushing a button for 2+ second is considered “long press” (hold).

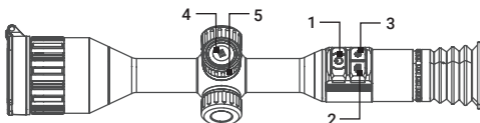







FIGURE 2-3. ADDER V² CONTROLS

TABLE 2-2. ADDER CONTROL FUNCTIONS

ITEM	CONTROLS	FUNCTIONS
1	 POWER BUTTON	Press: Standby mode / Wake up device Hold: Power ON/OFF
2	 CAPTURE BUTTON	Press: Image capture Hold: Start/Stop video recording
3	 LRF BUTTON	Press: Turning on the laser / Distance measurement Double-press: Turning off the laser Hold: Correct non-uniformity of display (Flat Field Calibration, FFC)
4	 MENU BUTTON	Press: Switch palettes Hold: Enter menu Menu Mode Press: Confirm / Set parameters Hold: Save and exit menu
5	NAVIGATION WHEEL	Rotate: Setting the magnification Menu Mode Rotate: Menu navigation
2+3	CAPTURE BUTTON + LRF BUTTON	Press and hold simultaneously: Lock/Unlock the navigation wheel

You can lock the navigation wheel to prevent accidental turning or pressing. If the wheel is locked, the icon  will be displayed in the left side of the screen when MENU button pushed or navigation wheel rotated. When unlocked, the icon will change to .

2.1.5 POWER ON AND OFF

Power On

With the battery installed, press and hold the POWER button  to turn on the device. The red LED power indicator in the POWER button will light up.

Power Off

When the device is turned on, hold the POWER BUTTON  to power off the device.

Auto Power Off

In the “Auto Power Off” submenu of General Settings you can set the time for the automatic shutdown of the device as required (see 2.2.34 for details).



The Auto Power Off countdown will start again when the device exits standby mode, or the device is restarted.

2.1.6 AUTO SCREEN OFF

Auto Screen Off function darkens the screen to save energy and increase battery time. However, the device stays on and you can view the live view on AGM Connect app when connecting the device to the app. The integrated algorithm automatically detects scope’s exact position and activates the Auto Screen Off function (see 2.2.19 for details).

2.1.7 STANDBY MODE

Standby mode is used to save battery power. In this mode, some power-consuming features such as the display, network hardware, or internal storage will be temporarily disabled.

In the view mode, press the POWER button . After a few seconds, the display will turn off. Press the POWER button  again to exit the Standby mode.

When the Auto Screen Off function is enabled, you can also tilt or rotate the device to wake it from standby mode.

2.1.8 VIEWING THE THERMAL IMAGE

1. Power on the rifle scope.
2. Open the lens cover and bring the scope to your eye. The internal display will show the thermal image and on-screen interface.
3. Use the diopter adjustment ring (rotating ring closest to your eye) to ensure that the on-screen interface elements are crisp and sharp. Once completed, this adjustment will not be needed again until a new user is using the device.

- Once the diopters are set, all image focusing for various distances will occur using the focus ring, which is located on the scope lens.

NOTE:

You must perform the focus adjustment before any further use of the scope.

- Set palette, brightness, contrast, sharpness, tone, and scene mode to display the best image effect.

2.1.9 ON-SCREEN DISPLAY

On-screen interface displays the menu items and device status indicators.

Use the MENU button  in the view mode to display or hide the menu.

Adjust the On-Screen Display (OSD) in the Function Settings menu (see 2.2.24).

When OSD is on, the information of Shot Activated Recording (SAR) function, WiFi hotspot activation, battery status, current magnification setting, time and date displays on the screen.

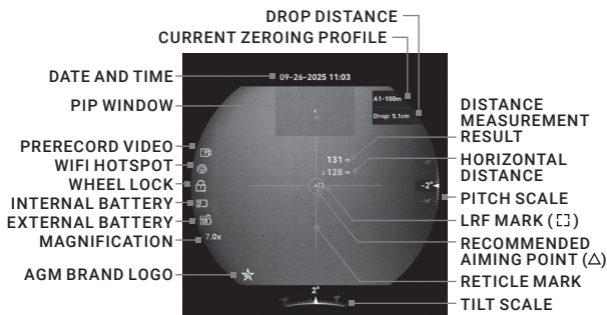

FIGURE 2-4. ON-SCREEN DISPLAY

The screen can also display the reticle, recommended aiming point, LRF mark, current zeroing profile, zeroing distance, distance measurement result, drop distance and the pitch scales. You can configure the display of all these elements in the scope's menu.

2.1.10 PALETTE SETTINGS

You can select different palettes to display the same scene in different effects. In the live view mode, press the MENU button  to select a mode (image palette).

TABLE 2-3. PALETTE SETTINGS

PALETTE	DESCRIPTION
WHITE HOT	The hot part is displayed in white. The higher the temperature, the lighter the color.
BLACK HOT	The hot part is displayed in black. The higher the temperature, the darker the color.
FUSION	The hot part is displayed in white. From high temperature to low temperature, the image is colored in from white, yellow, red, pink to purple.
RED HOT	The hottest part is displayed in red, the rest of the image will be flushed out in shades of gray.
RED MONOCHROME	The image is colored in shades of red. The higher the temperature, the lighter the color.
GREEN MONOCHROME	The image is colored in shades of green. The higher the temperature, the lighter the color.

2.1.11 DIGITAL ZOOM

AdderV² LRF supports 1x, 2x, 4x, 8x step zoom, as well as continuous zoom in 0.5x increments. Step/Incremental zoom mode can be selected in the menu. Then, in the live view mode, rotate the operation wheel to change the digital zoom. The current image magnification value is displayed on the screen.

When the Picture-in-Picture (PIP) function is activated, the image will be enlarged by the zoom factor only in the PIP window. In this case, the current PIP magnification is displayed in the corner of the PIP window.

The magnification ranges for different models are:

- AdderV² LRF 35-384: 4x - 24x
- AdderV² LRF 35-640: 2.5x - 24x
- AdderV² LRF 50-640: 3.5x - 26x
- AdderV² LRF 60-1280: 2.5x - 28x

2.1.12 DISTANCE MEASUREMENT

The device can detect the distance between the target and the observation position with built-in laser rangefinder.

Make the laser rangefinder settings in the menu (see details in part 2.2.17). Point the square mark of the rangefinder at the target and press the LRF button  to measure the distance to the target.

The distance measurement result is displayed in the screen center and will disappear after 10 seconds. If the distance measurement fails or cannot reach a valid value, "000" will be displayed. The device also supports the Horizontal Distance measurement function.

NOTE:

- Double-press LRF button  to turn off laser range finder.
- Laser ranging mode cannot be set if Ballistic Calculation is enabled and continuous laser ranging is not available.
- If the Continuous Laser Ranging mode is in use, it will be switched to Once mode after enabling Ballistic Calculation. When Ballistic Calculation is turned off, the laser ranging mode will be reverted to Continuous.

2.1.13 IMAGE CALIBRATION

AdderV² LRF uses shutterless technology (except 60-1280 model). It is based on continuous study of different grey backgrounds, and it is a dynamic correction process that does not lead to loss of image quality. This eliminates the need for periodic calibration pauses, ensuring you never miss a critical moment in the field.

You also can use **Manual** or **Semi-Auto** option to correct the non-uniformity of display when necessary. Hold the LRF button  in the view mode to correct the non-uniformity of display. See part 2.2.28 for more details on the Flat Field Correction function.

2.1.14 VIDEO RECORDING AND IMAGE CAPTURE

Video Recording



In the live view interface, hold the CAPTURE button  to start/stop video recording. Recording time information is displayed on the screen.

Image Capture

In the live view interface, press the CAPTURE button  to capture image.

NOTE:

When captured, the image freezes for 1 second and a prompt shows on the display.

For exporting captured videos and pictures, refer to Files Export.

2.1.15 FILE EXPORT

1. Connect the scope to your PC with USB cable and open the detected disk.
2. Go to the **AGM Content** folder and find the folder named with the shooting date. For example, if you capture a picture or record a video on June 2025, go to **AGM Content -> 202506**.
 - Select and copy the videos to PC and play the file with the player.
 - Select and copy the snapshots to PC and view the files.
3. Disconnect the device from your PC.

NOTE:

- The device displays image when you connect it to PC. But functions such as recording, capture and hot spot are disabled.
- When you connect the device to PC for the first time, it installs the drive program automatically.

You can also download files from the scope to your phone using the AGM Connect app (see section 2.3).

2.1.16 INSTALLING THE ADDER ON A PICATINNY/ WEAVER RAIL WITH QUICK RELEASE MOUNT

You can mount the Adder scope on a Picatinny/Weaver rail of weapon using quick release (QR) mount (Figure 2-5).

1. Unlock the clamping devices of the QR mount by pushing down on the lever holders (A) and unlocking the levers (B).
2. Install the mount on the Picatinny/ Weaver rail so that the stops (C) slide into the transverse slots on the rail.
3. Affix the mount to the rail by locking the levers (B).
4. Verify that the clamping devices are firmly holding the mount. If necessary, adjust each clamping device's lever-cam lock as detailed below:

- 1) Remove the QR mount from the rail.
- 2) With the clamping device unlocked, push the cam (D) towards the arrow, which will cause the nut (E) to slide out of its hole.
- 3) To tighten/ loosen the clamping device, push down on the cam (D) and turn the nut (E) CW/ CCW respectively, in one-two increments (see note below). Much like when the cam (D) is released, backward-moving spring will cause the nut (E) to slide back into its hole.

NOTE:

The eight-sided nut of the mount lever-cam lock will only fit into their hole if turned in one of the discrete positions, using increments equal to $360^{\circ}/8$.

- 4) Verify that the adjusted lever-cams lock securely hold the weapon mounting rail.
5. Remove all screw (F) along with the ring halves (G) and (H) (you can remove the QR mount from the rail for convenience).
6. Place the scope between the halves of the rings and slightly fixing it with the screws (F) only enough to allow the scope to rotate and move back and forth.
7. Place the QR mount with the scope mounted on the weapon rail and affix it by locking the levers. Adjust the eye relief. Position the scope far enough to keep your eye safe from recoil.
8. Turn on the power of the scope and activate the reticle.
9. With the rifle held level, rotate the scope until the reticle is precisely vertical and horizontal.
10. Check the position of the scope and tighten the ring screws. Ensure an even fit by alternately tightening the screws.

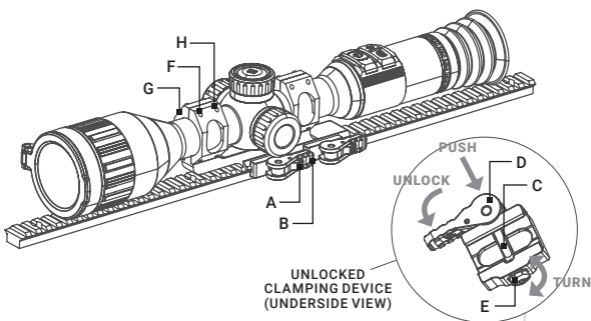



FIGURE 2-5. INSTALLATION WITH QUICK RELEASE MOUNT

2.2 MAIN FUNCTIONS

2.2.1 MENU OPERATION

When the device is turned on, press and hold the MENU button  to display the menu.

Rotate the operation wheel to move between menu items. The active element is highlighted in orange. Press the MENU button  to select menu item or change an option. Hold MENU button  to exit the menu.

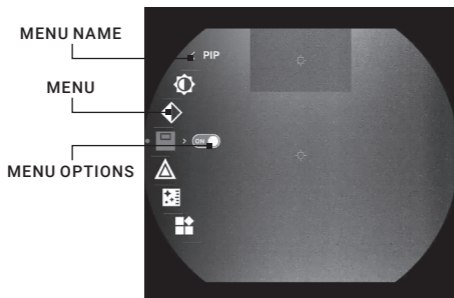































FIGURE 2-6. MAIN MENU











TABLE 2-4. MENU FUNCTIONS

MENU ITEM	SYMBOL	OPTION	FUNCTION
BRIGHTNESS		10 Levels of Brightness	Adjusts the image brightness.
CONTRAST		10 Levels of Contrast	Adjusts the image contrast.
PIP		OFF / ON	Enables or disables the Picture-in-Picture (PIP) mode.
SHARPNESS		5 Levels of Sharpness	Adjusts the image sharpness.
ZOOM PRO		OFF / ON	Enables or disables the Zoom Pro function.





MENU ITEM	SYMBOL	OPTION	FUNCTION
ADVANCED SETTINGS		Advanced Settings Menu:	
ZEROING PROFILES		5 Profiles (A/B/C/D/E)	Zeroing profile selection with user saved zeroing settings.
ZEROING		Zeroing Menu:	
Zeroing		OFF / 1 / 2 / 3 / 4 / 5	Zeroing settings selection or disable reticle.
Bullet		Bullet Name	Setting the bullet name (9 characters).
Type		10 Reticle Type	Setting the reticle type.
Reticle Color		4 Reticle Colors	Setting the reticle color (black, white, red, green).
Reticle Center Color		4 Reticle Center Colors	Setting the reticle center color (black, white, red, green).
Correction		Correction Menu:	
Distance		Distance to the target	Setting the distance to the target.
Zoom		Depends on the model	Setting the magnification with Digital Zoom.
Freeze Screen		OFF / ON	Image freeze.
X/Y Axis		X / Y	Switching the X and Y axes of correction. Setting the correction.
Ballistic Calculation		Ballistic Calculation Menu:	
Ballistic Calculation		OFF / ON	Enables or disables the ballistic calculation.
Aim Point Style		4 Aim Point Styles	Setting the aim point style (*, x, >•<, Δ).

MENU ITEM	SYMBOL	OPTION	FUNCTION
Aim Point Color		4 Aim Point Colors	Setting the aim point color (black, white, red, green).
Parameters		Drag Model / Initial Velocity / Altitude / Temperature / Ballistic Coefficient / Sight Height	Input the data to display the recommended aiming point and the drop distance.
RETICLE MODE		Central Reticle / Fixed Reticle	You can select a reticle mode according to your preference and different situations
ZOOM MODE		Step / Incremental	Set Zoom Mode.
PRERECORD		OFF / 5s / 10s / 15s	Setting the recording time before and after the recoil activation.
TONE		Cold / Warm	Switch between the Cold mode and Warm mode.
SCENE MODE		General / Compressed	Switch between the General mode and Compressed mode.
LASER RANGING		Laser Ranging Menu:	
Ranging Mode		Once / Continuous (5s, 10s, 15s, 30s, 60s)	LRF distance measurement settings.
Horizontal Distance		OFF / ON	Enables or disables the display of horizontal distance.
NETWORK		Close / Hotspot	Enables or disables the WiFi hotspot.



MENU ITEM	SYMBOL	OPTION	FUNCTION
AUTO SCREEN OFF		OFF / ON	Function darkens the screen to save energy.
AUDIO		OFF / ON	Enable or disable audio recording.
ALBUMS		---	View/Delete local files.
HOT TRACKING		OFF / ON	Enables or disables hot spot mark (marking the spot of highest temperature).
CHANNEL VIEWING ACTIVATION		OFF / ON 6 palettes	Setting up the display of different palettes for selection.
FUNCTION SETTINGS		Function Settings Menu:	
OSD		OSD / Time / Date	Enables or disables OSD, time, date.
Pitch Scale		OFF / ON	Enables or disables Pitch Scale to view the device inclination angle in the live view.
Brand Logo		OFF / ON	Enables or disables AGM logo on the screen.
USB Connection		USB Flash Drive/ Digital	USB port mode settings.
Image Calib.		Auto (60-1280 Only) / Semi-Auto / Manual	Selecting the Flat Field Correction (FFC) mode.
DPC		Axis: X/Y	Correction of dead pixel manually.
Burn Prevention		OFF / ON	Enables or disables the Burn Prevention function.

MENU ITEM	SYMBOL	OPTION	FUNCTION
GENERAL SETTINGS		General Settings Menu:	
Language		24 Languages	Choice of interface language.
Time		12 / 24 hour	Time setting.
Date		Month/Day/Year	Date setting.
Unit		yd / m	Sets the distance unit.
Auto Power Off		OFF / 15 min / 30 min / 45 min	Setting the automatic shutdown time.
Reboot		---	Restoring the default device settings.
Restore Factory Settings		---	Restoring the default device settings, erase zeroing settings and all internal storage content.
Diagnostic Log		OFF / ON	Using for recording device status and troubleshooting.
Version		---	Firmware version, serial number and free space of built-in storage.

2.2.2 BRIGHTNESS ADJUSTMENT

1. Hold the MENU button  in live view interface to call the Main Menu, then select the  Brightness menu item and hold the MENU button  to confirm.
2. Rotate the wheel to adjust the brightness. You can select one of ten levels of the brightness to adjust the image lighter or darker.
3. Hold the MENU button  to exit brightness adjustment.

2.2.3 CONTRAST ADJUSTMENT

1. Hold the MENU button  in live view interface to call the Main Menu, then select the  Contrast menu item and hold the MENU button  to confirm.

2. Rotate the wheel to adjust the image contrast. You can select one of ten levels of the contrast.
3. Hold the MENU button  to exit contrast adjustment.





2.2.4 PICTURE IN PICTURE MODE

The Picture-in-Picture (PIP) mode allows you to see simultaneously both a magnified image of the central part in a PIP window and the main image. The PIP window is displayed at the up-center of the live view. When you change the zoom level, the current PIP magnification is displayed in the corner of the PIP window.

NOTE:





- When the reticle is enabled, the PIP view displays a magnified area around the center of the crosshair. When the reticle is not enabled, the PIP view displays a magnified central area of the image.
- If the PIP function is activated, the image will be enlarged by the zoom factor only in the PIP window.
- To prevent the large reticle in the PIP view from obscuring the target and the aim point, only the reticle center is retained in the PIP window (reticle types 5, 6, and 10 will not be changed).

You can activate the Picture-in-Picture (PIP) function in the Main Menu.

1. Hold the MENU button  in live view interface to call the Main Menu and then select the  PIP menu item.
2. Press the MENU button  to enable or disable PIP mode. The PIP window show in the upper part of screen.
3. Hold the MENU button  to exit PIP setting.





2.2.5 SHARPNESS SETTING

This function allows you to adjust the sharpness of the thermal image.

1. Hold the MENU button  in live view interface to call the Main Menu, then select the  Sharpness menu item and hold the MENU button  to confirm.
2. Rotate the wheel to adjust the image sharpness.
3. Hold the MENU button  to exit .

2.2.6 ZOOM PRO



When you turn on Zoom Pro function, the details of zoomed image will be enhanced.

1. Hold the MENU button  in live view interface to call the Main Menu, then select the  Zoom Pro menu item and press the MENU button  to enable or disable Zoom Pro mode.
2. Rotate the wheel to select other item or hold the MENU button  to exit a menu.

NOTE:





- If the PIP function is enabled, Zoom Pro is only enabled in the PIP view.
- Zoom Pro cannot be enabled when device battery is low.

2.2.7 ADVANCED SETTINGS MENU

Hold the MENU button  in the view interface to call the Main Menu. Select the  Advanced Settings menu and press the MENU button  to confirm. The Advanced Settings menu contains all the necessary parameters to fully configure the device.

2.2.8 ZEROING PROFILES

The user can customize and save five profiles with different reticle settings. In each profile, you can configure up to five types of reticle, firing distances and reticle corrections.

1. Enter the  Advanced Settings menu.
2. Rotate the wheel to select  Zeroing Profiles menu item and press the MENU button  to confirm.
3. Rotate the wheel to switch the zeroing profile.
4. Hold the MENU button  to exit Zeroing Profile setting.

The right top of the image displays the reticle information. For example, A1-100m means you are using the Zeroing No. 1 in the Profile A, and the set range is 100 m.

NOTE:









There are 5 zeroing profiles in total, and you can configure 5 reticles, zeroing distances and corrections in each zeroing profile.

2.2.9 ZEROING

You can select a reticle in the current zeroing profile, and set parameters such as reticle type, color, and boresight correction (coordinates) for the reticle.



Select a zeroing profile initially (refer to 2.2.8).

1. Enter the  Advanced Settings menu.

2. Rotate the wheel to select  **Zeroing** menu item and press the MENU button  to enter the zeroing setting interface.
3. Set zeroing number (from 1 to 5).
 - 1) Rotate the wheel to select  **Zeroing** and press the MENU button  to confirm.
 - 2) Rotate the wheel to select **OFF** (reticle is disabled) or zeroing number you want to correct and press the MENU button  to confirm.
4. Set reticle type (for parameters of built-in reticles, see part 5.2).
 - 1) In the zeroing setting interface rotate the wheel to select  **Type** submenu and press the MENU button  to confirm.
 - 2) Rotate the wheel to select a reticle type and press the MENU button  to confirm.





NOTE:

The scale intervals of the Reticle 4 and Reticle 7 change synchronously under the current digital zoom.

5. Set reticle color.
 - 1) In the zeroing setting interface rotate the wheel to select  **Color** submenu and press the MENU button  to confirm.
 - 2) Rotate the wheel to select black, white, red or green color of reticle and press the MENU button  to confirm.

NOTE:

In Black Hot mode and White Hot mode, if you set the reticle color as white or black, the reticle colors can be automatically inverted depends on thermal image around the reticle.













6. Set reticle center color.
 - 1) In the zeroing setting interface rotate the wheel to select  **Reticle Center Color** submenu and press the MENU button  to confirm.
 - 2) Rotate the wheel to select black, white, red or green color of reticle center and press the MENU button  to confirm.
7. (Optional) Repeat 3 to 6 to set type and color for other reticles in this profile.
8. Hold the MENU button  to save and exit.

2.2.10 BORESIGHTING / SETTING YOUR ZERO





Like any daytime rifle scope or red dot, sighting in is both similar, and simplified. The AdderV² LRF comes with a one-shot zeroing system, which makes initial sighting in quick and painless.

Set the target to the selected zeroing distance. We recommend 50-100 yards initially. Select a zeroing profile (refer to 2.2.8). You can use different zeroing profiles if you want to use the optic on a different rifles.

Align the reticle with the center of the target and shoot. If the point of impact does not coincide with the aiming point, correct the reticle.

1. Enter  **Advanced Settings** menu.
2. Rotate the wheel to select  **Zeroing** menu item and press the MENU button  to enter the zeroing setting interface.
3. Rotate the wheel to select  **Zeroing** and press the MENU button  to confirm. Rotate the wheel to select zeroing number you want to correct and press the MENU button  to confirm.
4. Rotate the wheel to select  **Bullet** and press the MENU button  to set the bullet name for your reticle profiles. Press the MENU button  to select the character to edit (color of selected digit will changed to the red), and rotate the wheel to change the character. After you finish to entering the bullet name, hold the MENU button  to exit.
5. Rotate the wheel to select  **Correction** and press the MENU button  to enter the boresight correction interface.

Set the distance to the target:

- 1) In the boresight correction interface rotate the wheel to select  **Distance** and press the MENU button  to confirm.
- 2) Press the MENU button  to select the digit you want to change (color of selected digit will changed to the red).
- 3) Rotate the wheel to change the number and press the MENU button  to confirm.

(Optional) Set the magnification:



- 1) In the boresight correction interface rotate the wheel to select  **Zoom** option and press the MENU button  to confirm.





FIGURE 2-7. BORESIGHTING

- 2) Rotate the wheel to enlarge the image until the target positions is clear enough. Press the MENU button  to confirm.

NOTE:

We'd suggest zeroing in minimal magnification (true optical base magnification), or 2x zoom (double optical magnification) as these options are less pixelated and should provide for easier adjustments.

(Optional) Activate Freeze Screen function:

- 1) In the boresight correction interface rotate the wheel to select  Freeze Screen option.
- 2) Press the MENU button  to enable the Freeze Screen function.

NOTE:

When enabling the Freeze Screen function, you can adjust the position of the cursor on a frozen image. This feature helps prevent image flutter and eliminates the need to hold the rifle scope steady in order to make your windage and elevation adjustments on screen.

6. Set the correction:

- 1) In the boresight correction interface rotate the wheel to select  X/Y Axis and press the MENU button  to confirm.

Two marks are displayed on the screen. The first mark is the reticle selected in the Zeroing menu. The second, small crosshair is the reference mark. The reference mark is located in the center of the screen. Initially, the centers of both marks are aligned. Zero the scope by moving the reticle on the screen.

- 2) Aim the reticle at the center of target.
- 3) Press the MENU button  to select X or Y axis.
- 4) Rotate the wheel to move reticle left and right (if X axis is selected) or to move reticle up and down (if Y axis is selected).

Holding the reference small crosshair at the aiming point (center of the target) and move the reticle until it is aligned with the point of impact. The coordinates show the current position of the reticle. It also displays the distance by which the point of impact will move, taking into account the set distance to the target.



7. Hold the MENU button  to save reticle position and exit.
8. (Optional) Repeat 3 to 7 to set the position for other reticles in this profile. You can place up to five zeroes at different distances within the same profile (useful for certain calibers with highly fluctuating trajectories between 50 and 250 yards/meters).

TABLE 2-5. BORESIGHT CORRECTIONS

MODEL	RETICLE OFFSET	BORESIGHT INCREMENT
AdderV ² LRF 35-384	1 pixel per 1 click	0.11 mil / 0.38 MOA / 1.1 cm at 100 m distance / 0.4 in at 100 yd distance
AdderV ² LRF 35-640	1 pixel per 1 click	0.18 mil / 0.63 MOA / 1.8 cm at 100 m distance / 0.7 in at 100 yd distance
AdderV ² LRF 50-640	1 pixel per 1 click	0.13 mil / 0.44 MOA / 1.3 cm at 100 m distance / 0.5 in at 100 yd distance
AdderV ² LRF 60-1280	1 pixel per 1 click	0.2 mil / 0.69 MOA / 2 cm at 100 m distance / 0.7 in at 100 yd distance

9. Hold the MENU button  to exit Zeroing menu. The window “Save the parameters?” will appear.
 - OK: Save the settings and exit.
 - CANCEL: Exit without saving the settings.

You can also quickly zero your scope using the **AGM Connect** app.

Install the application on your phone and connect your thermal device via WiFi hotspot as described in Chapter 2.3.















1. Run the application.
2. Select your device in the application menu.
3. Select **Zero** in the **Device Info** section.
4. The zeroing interface will appear on the screen of your smartphone. Following the instructions on the screen, make the settings similar to those described above in Paragraph 2.2.10.

2.2.11 BALLISTIC CALCULATION

The ballistic calculation helps you have a better experience in various conditions. Multiple parameters are required in calculation to ensure precision and flexibility of use. The ballistic calculation supports pitch angle compensation. The device can automatically adjust the position of the recommended aiming point mark by reading the pitch angle data from the gyroscope and entering it into the algorithm.

NOTE:

- Make sure the reticle is enabled and you have finished zeroing.
- Continuous laser ranging is not available when enabling ballistic calculation.

1. Enter  Advanced Settings menu. Select  Zeroing /  Zeroing and set the zeroing number you want to correct.
2. Rotate the wheel to select  Ballistic Calculation. Press the MENU button  to enter the setting interface.
3. In the Ballistic Calculation interface select  Ballistic Calculation and press the MENU button  to enable/disable this function.
4. Select  Aim Point Style and press the MENU button  to confirm. Rotate the wheel to set the style of the aim point (•, X, >•<, Δ). Press the MENU button  to exit Aim Point Style setting.
5. Select  Aim Point Color and press the MENU button  to confirm. Rotate the wheel to set the color of the aim point (black, white, red, green). Press the MENU button  to exit Aim Point Color setting.
6. Select  Parameters and press the MENU button  to enter the parameter configuration interface. Rotate the wheel to select the following parameters, and press the MENU button to input the data.

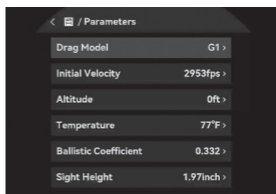
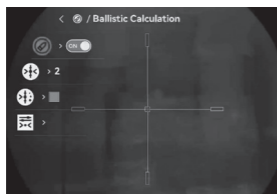

FIGURE 2-8. BALLISTIC CALCULATION

Drag Model: Set the bullet-specific drag model, e.g. G1, G7 and GS.

Initial Velocity: Input the muzzle velocity of your projectile.

NOTE:

Velocity varies depending on different conditions, barrel length, etc. Muzzle velocity can be obtained by using an accurate ballistic chronograph and/or by following ammo manufacturer specifications.



Altitude: Set current local altitude.

Temperature: Set the ambient temperature.

Ballistic Coefficient (B.C.): The measure of its ability to overcome air resistance.

Sight Height: The distance between the bore and the center of the lens.

Press the MENU button  to switch digit, and rotate the wheel to change the number.



7. Hold the MENU button  to save and exit.
8. Aim the LRF mark at the target and press LRF button  to measure the distance. The screen will display the recommended aiming point (for example, red triangle Δ) and the drop distance in the upper right corner of the interface.
9. (Optional) To adjust distance, repeat the step 8.

NOTE:

- Ballistic calculations is linked to Zeroing Profiles and Zeroing number. 25 ballistic profiles can be saved. You can create a complete set of profiles containing zeroed reticles and ballistic information.
- The more parameters you specify, the more accurate the recommended aiming point will be.
- The drop distance is related to the input parameters. Please refer to the actual situation.

2.2.12 RETICLE MODE

You can select a reticle mode according to your preference and different situations.

1. Enter the  **Advanced Settings** menu.
2. Rotate the wheel to select  **Reticle Mode** and rotate the wheel to select a reticle mode.

Central Reticle: This mode centers around the reticle when switching the digital zoom ratio, with the reticle and zoomed image moved to the center of the display.

Fixed Reticle: This mode centers around the reticle when switching the digital zoom ratio, with the reticle position unchanged.



3. Hold the MENU button  to confirm the selection and exit.

NOTE

- The actual zoom ratio returns to the min. value when switching the reticle mode.
- The zoom ratio may vary according to different models. Please take the actual product for reference.

2.2.13 ZOOM MODE

AdderV² LRF supports 1x, 2x 4x, 8x Step Zoom, as well as Incremental Zoom in 0.5x increments.

1. Enter the  Advanced Settings menu.
2. Rotate the wheel to select  Zoom Mode and rotate the wheel to select a reticle mode.

Step Zoom: In this mode, the image is enlarged with a fixed zoom factor of 1x, 2x 4x or 8x.

Incremental Zoom: In this mode, the image is enlarged continuously in 0.5x increments.

3. Hold the MENU button  to confirm the selection and exit.





In the live view mode, rotate the operation wheel to change the digital zoom. The current image magnification value is displayed on the screen.

NOTE:

When the Picture-in-Picture (PIP) function is activated, the image will be enlarged by the zoom factor only in the PIP window. The current PIP magnification is displayed in the corner of the PIP window.





2.2.14 PRERECORD VIDEO

After enabling the Shot Activated Recording (SAR) function, the device will automatically start recording 5, 10, or 15 seconds before and after the recoil-activation.

1. Enter the  Advanced Settings menu.
2. Rotate the wheel to select  Prerecord and press the MENU button  to confirm.
3. Rotate the wheel to select OFF (SAR function disabled) or 5s, 10s, or 15s recording time and press the MENU button  to confirm the selection and exit.





2.2.15 IMAGE TONE SETTING

This function allows you to change the tone of thermal image to warm or cold.

1. Enter the  **Advanced Settings** menu.
2. Rotate the wheel to select  **Tone** menu item and hold the MENU button  to confirm.
3. Rotate the wheel to select Warm or Cold tone.
4. Hold the MENU button  to exit .









2.2.16 SCENE MODE

You can select proper Scene Mode according to environment temperature to improve the display effect.

1. Enter the  **Advanced Settings** menu.
2. Rotate the wheel to select  **Scene Mode** menu item and hold the MENU button  to confirm.
3. Rotate the wheel to switch scene mode:
General mode: improves an image so that the object edge is more distinct.
Compressed mode: is more suitable for hunting environment because of the highlight function of small objects.
4. Hold the MENU button  to exit.

2.2.17 SET LASER RANGING

The device can detect the distance between the target and the observation position with built-in laser rangefinder.

1. Enter the  **Advanced Settings** menu.
2. Rotate the wheel to select  **Laser Ranging** menu item and press the MENU button  to confirm.
3. Rotate the wheel to select  **Ranging Mode** submenu and press the MENU button  to open the options.
4. Rotate the wheel to select the laser ranging mode between **Once** and **Continuous (5s)**, **Continuous (10s)**, **Continuous (15s)**, **Continuous (30s)**, **Continuous (60s)**. Press the MENU button  to set selected mode.
5. Rotate the wheel to select  **Horizontal Distance** option, and press the MENU button  to turn on or off the display of the horizontal distance between the target and the observation position on the screen.
6. Hold the MENU button  to confirm and exit.

NOTE:

When ballistic calculations are enabled, only Once ranging mode is supported.





When the **Once Mode** is selected, point the square mark of the rangefinder at the target and press the LRF button  to measure the distance to the target.

You can scan the surroundings under **Continuous Mode**. Continuous distance scanning will occur for a set time of 5, 10, 15, 30 or 60 seconds after pressing the LRF button . The measurement result will be refreshed every second.

The distance measurement result is displayed in the screen center and will disappear after 10 seconds. When “Horizontal Distance” option enabled, the horizontal distance will be displayed on the second line with symbol Δ . If the distance measurement fails or cannot reach a valid value, “000” will be displayed.

2.2.18 NETWORK

Connect your phone to the WiFi hotspot of the rifle scope, you can configure the parameters and realize functions of the device.

1. Enter the  **Advanced Settings** menu.
2. Rotate the wheel to select  **Network** menu item and press the MENU button  to enable or disable WiFi hotspot.
3. Hold the MENU button  to exit.





Open the AGM Connect APP and connect your phone with the device (refer to Section 2.3). You can view the interface of rifle scope on your phone.

NOTE:

- To save power, the WiFi hotspot will automatically turn off if there is no connection for 10 minutes.
- When the power is less than 15%, the WiFi hotspot function will be turned off automatically.

2.2.19 AUTO SCREEN OFF

Auto screen off function darkens the screen to save energy and increase battery time. However, the device stays on and you can view the live view on AGM Connect app when connecting the device to the app.

1. Enter the  **Advanced Settings** menu.
2. Rotate the wheel to select  **Auto Screen Off** menu item. Press the MENU button  to enable or disable Auto Screen Off function.
3. Rotate the wheel to select other menu item or hold the MENU button  to exit.

You can use one of the following methods to enter the standby mode when the display is turned on:





- Tilt the device downwards more than 70°.
- Rotate the device horizontally more than 45°.
- Keep the device still and do not move it for 5 minutes.

You can do one of the following methods to wake up the device when the display is turned off:

- Tilt the device downwards from 0° to 60° or upwards .
- Rotate the device horizontally from 0° to 40°.
- Press the POWER button  to wake up the device.



2.2.20 AUDIO RECORDING SETTING

The Audio function allows you to record sound along with video. If there is too much noise when recording, this function can be disabled.

1. Enter the  **Advanced Settings** menu.
2. Rotate the wheel to select  **Audio** menu item, and press the MENU button  to enable or disable audio recording.
3. Rotate the wheel to select other menu item or hold the MENU button  to exit.



2.2.21 ALBUMS

Captured images and recorded videos are automatically stored in the device, and you can view the files in local albums.

1. Enter the  **Advanced Settings** menu.
2. Rotate the wheel to select the  **Albums** menu item and press the MENU button  to confirm.

NOTE:



The albums are automatically created and named by year + month. The local pictures and videos of a certain month are stored in the corresponding album. For example, the pictures and videos of July in 2025 are saved in the album named “202507”.

3. Rotate the wheel to select the album, and press the MENU button  to enter the selected album.
4. Rotate the wheel to select a file to view.
5. Press the MENU button  to view the selected file and relevant information.

NOTE:





Files are arranged in chronological order, with the most recent at the top. If you fails to find the most recently taken snapshots or videos, please check the time and date settings of your device. When you are viewing files, you can switch to other files by rotating the wheel.

When you are viewing videos, you can press the wheel to play or stop the video.

To delete an album or file, you can press and hold  +  buttons at the same time to pop up a dialog box and delete the album or the file according to the prompt.

2.2.22 HOT TRACKING





The device can detect the highest temperature spot in the scene and mark it on display.

1. Enter the  **Advanced Settings** menu.
2. Rotate the wheel to select  **Hot Tracking** menu item and press the MENU button  to enable/disable hot spot mark (marking the spot of highest temperature).
3. Rotate the wheel to select other menu item or hold the MENU button  to exit.

When the hot spot mark is enabled, the green cross mark  displays in the spot of the highest temperature. When the scene changes, the green mark moves.

2.2.23 CHANNEL VIEWING ACTIVATION

You can select different palettes to display the same scene in different effects. In the live view mode, press the MENU button  to select a mode (image palette).

1. Enter the  **Advanced Settings** menu.
2. Rotate the wheel to select the  **Channel Viewing Activation** menu and press the MENU button  to open the options.
3. Rotate the wheel to select the palette required, and press the MENU button  to enable or disable it.







NOTE:

At least one palette should be enabled.

4. Hold the MENU button  to exit.







2.2.24 ON-SCREEN DISPLAY (OSD)

You can choose which information to display in the live view user interface. Options include: OSD (prerecord video indicator, WiFi hotspot activation, battery status indicator, current magnification), time and date. These will appear on the screen when activated.

1. Enter the  **Advanced Settings** menu.
2. Rotate the wheel to select  **Function Settings** menu and press the MENU button  to confirm.
3. Rotate the wheel to select  **OSD** submenu and press the MENU button  to enter.
4. Rotate the wheel to select the **OSD, Time or Date**. Press the MENU button  to display or hide the necessary information.
5. Hold the MENU button  to exit.







2.2.25 PITCH SCALE

You can enable pitch scale to view the device inclination angle in the live view.

1. Enter the  **Advanced Settings** menu.
2. Rotate the wheel to select  **Function Settings** menu and press the MENU button  to confirm.
3. Rotate the wheel to select  **Pitch Scale** and press the MENU button  to turn the on-screen pitch scale on or off.
4. Rotate the wheel to select other menu item or hold the MENU button  to exit.

2.2.26 BRAND LOGO







You can display the AGM logo in the lower left corner of the screen.

1. Enter the  **Advanced Settings** menu.
2. Rotate the wheel to select  **Function Settings** menu and press the MENU button  to confirm.
3. Rotate the wheel to select  **Brand Logo** menu item. Press the MENU button  to enable/disable logo.
4. Rotate the wheel to select other item or hold the MENU button  to exit.

2.2.27 USB CONNECTION

The USB port can be used to transfer data to a PC, charge the installed batteries, or casting screen to PC by UVC protocol-based client software or player. You can view the device screen image on

the monitor to get a better and clearer image, more convenient to checking the details.

1. Enter the  **Advanced Settings** menu.
2. Rotate the wheel to select  **Function Settings** menu and press the MENU button  to confirm.
3. Rotate the wheel to select  **USB Connection** submenu and press the MENU button  to enter the configuration interface.
4. Rotate the wheel to select **USB Flash Drive** for transfer data or charge the battery, or **Digital** to casting screen to PC.
5. Hold the MENU button  to exit a menu.

2.2.28 IMAGE CALIBRATION

The image calibration function performs what is known as the Flat Field Correction (FFC). This is required of all thermal devices. This can correct for non-uniformity of the display.





AdderV² uses shutterless technology. It is based on continuous study of different grey backgrounds, and it is a dynamic correction process that does not lead to loss of image quality. This eliminates the need for periodic calibration pauses, ensuring you never miss a critical moment in the field.

NOTE:

The AdderV² LRF 60-1280 does not use shutterless technology. This model has an additional Auto mode in the menu. During automatic correction an internal shutter will be lowered in front of the thermal detector. A “click” sound will often be heard, and the image is momentarily interrupted for a split second. After this quick process the detector will be re-calibrated, and the image becomes more accurate. AGM recommends automatic when scanning for game or targets. However, we recommend going into the menu and changing to Manual correction mode when getting close making your shot. This will prevent any unwanted auto-correction occurring when tracking live game. This will help shooters in making ethical shot placements at all times.



You can also go into the menu and switch to Semi-Auto or Manual correction mode. During correction an internal shutter will be lowered in front of the thermal detector. A “click” sound will be heard, and the image is momentarily interrupted for a split second. After this quick process the detector will be re-calibrated, and the image becomes more accurate.

1. Enter the  **Advanced Settings** menu.

2. Rotate the wheel to select  **Function Settings** menu and press the MENU button  to confirm.
3. Rotate the wheel to select  **Image Calib.** submenu and press the MENU button  to enter.
4. Rotate the wheel to switch the FFC mode.

Auto (only for AdderV² LRF 60-1280): The rifle scope performs FFC automatically when switching on or rebooting the camera.









Semi-Auto: Hold the LRF button  in live view to correct the non-uniformity of display.

Manual: Cover the lens cap, then hold the LRF button  in live view to correct the non-uniformity of display.
5. Hold the MENU button  to exit.

2.2.29 DEFECTIVE PIXELS CORRECTION

The Defective Pixel Correction (DPC) can help users repair the occasional de-activated pixel within the display. This is fairly common in thermal optics, which is why so many of these optics come equipped with a DPC feature. 1-3 dead pixels are usually easily repaired by the user. Anything over 3 that cannot be repaired, will open the unit up to an approved warranty repair by AGM at their facility.







Before you start switch the palette to White Hot mode.

1. Enter the  **Advanced Settings** menu.
2. Rotate the wheel to select  **Function Settings** menu and press the MENU button  to confirm.
3. Rotate the wheel to select  **DPC** submenu and press the MENU button  to enter.
4. Press the MENU button  to select the X or Y axis.
5. Rotate the wheel to set the coordinates until the cursor reaches the dead pixel. The screen will display a magnified area around the selected pixel.
6. Press the MENU button  twice to correct the dead pixel.
7. (Optional) Repeat 4 to 6 to correct the position for other dead pixels.
8. Hold the MENU button  to exit.

2.2.30 BURN PREVENTION







This function can prevent damage to the thermal sensor from the sun or other high temperature bright light sources. When enabling this function, the shield will close until the environment turns to normal. This feature may be useful to help protect sensitive displays

during extreme summer temperatures. AGM recommends all units be stored in room temperature whenever possible, as long periods of storage in extreme heat (such as inside a vehicle) may lead to issues with the display materials.







1. Enter the  **Advanced Settings** menu.
2. Rotate the wheel to select  **Function Settings** menu and press the MENU button  to confirm.
3. Rotate the wheel to select  **Burn Prevention** submenu and press the MENU button  to enable or disable the Burn Prevention function.
4. Rotate the wheel to select other item or hold the MENU button  to exit.

2.2.31 LANGUAGE SETTING





You can select different languages of user interface.



1. Enter the  **Advanced Settings** menu.
2. Rotate the wheel to select  **General Settings** and press the MENU button  to confirm.
3. Rotate the wheel to select  **Language** submenu and press the MENU button  to enter.
4. Rotate the wheel to select the language as required and press the MENU button  to confirm.
5. Hold the MENU button  to exit.

2.2.32 TIME SETTING

1. Enter the  **Advanced Settings** menu.
2. Rotate the wheel to select  **General Settings** and press the MENU button  to confirm.
3. Rotate the wheel to select  **Time** submenu and press the MENU button  to enter the configuration interface.
4. Press the MENU button  to select the hour, minute, second to be synchronized and Rotate the wheel to change the number.
5. Hold the MENU button  to exit.







2.2.33 DATE SETTING

1. Enter the  **Advanced Settings** menu.
2. Rotate the wheel to select  **General Settings** and press the MENU button  to confirm.
3. Rotate the wheel to select  **Date** submenu and press the MENU button  to enter the configuration interface.

4. Press the MENU button  to select the month, day or year to be synchronized and Rotate the wheel to change the number.
5. Hold the MENU button  to exit.







2.2.34 UNIT SETTING

You can set the unit (yards or meters) of measurement for distance.

1. Enter the  Advanced Settings menu.
2. Rotate the wheel to select  General Settings and press the MENU button  to confirm.
3. Rotate the wheel to select  Unit submenu and press the MENU button  to enter the  configuration interface.
4. Rotate the wheel to select **yd** (yards) or **m** (meters).
5. Hold the MENU button  to exit a menu.





2.2.35 AUTO POWER OFF

You can set the time for the automatic shutdown of the device as required.

1. Enter the  Advanced Settings menu.
2. Rotate the wheel to select  General Settings and press the MENU button  to confirm.
3. Rotate the wheel to select  Auto Power Off submenu and press the MENU button  to enter the configuration interface.
4. Rotate the wheel to select OFF, 15 min, 30 min or 45 min.
5. Hold the MENU button  to exit.





2.2.36 REBOOT

You can reset all the basic settings (Brightness, Contrast, Sharpness, PIP, etc.) to default values.

1. Enter the  Advanced Settings menu.
2. Rotate the wheel to select  General Settings and press the MENU button  to confirm.
3. Rotate the wheel to select  Reboot and press the MENU button . The window "Reset the basic settings" will appear.
 - OK: Restore the basic settings to defaults.
 - CANCEL: Exit without changing the settings.







2.2.37 RESTORE FACTORY SETTINGS

You can reset all device settings and delete all contents of the built-in storage.

1. Enter the  **Advanced Settings** menu.
2. Rotate the wheel to select  **General Settings** and press the MENU button  to confirm.
3. Rotate the wheel to select  **Restore Factory Settings** and press the MENU button . The window “Erase all content and settings” will appear.
 - **OK**: Erase all content and restore all settings to defaults.
 - **CANCEL**: Exit without changing the settings.





2.2.38 DIAGNOSTIC LOG

Diagnostic Log using for recording device status and troubleshooting. You can find the log files in the *log* folder in the device memory and send them to the support service if necessary (see paragraph 2.1.17 about exporting files).

1. Hold the MENU button  to show the menu.
2. Rotate the wheel to select  **General Settings** and press the MENU button  to confirm.
3. Rotate the wheel to select  **Diagnostic Log** and press the MENU button . A confirmation window will appear.
4. Select **OK** and press the MENU button  to start recording the log.

2.2.39 VERSION

You can view the device information such as firmware version, serial number and free space of built-in storage.

1. Enter the  **Advanced Settings** menu.
2. Rotate the wheel to select  **General Settings** and press the MENU button  to confirm.
3. Rotate the wheel to select  **Version** item and press the MENU button  to confirm. The firmware version, serial number and memory capacity will be displayed.



2.3 CLIENT SOFTWARE INTRODUCTION

Search the AGM Connect software in App Store (iOS System) or Google Play™ (Android System) and install the application on your mobile phone. Turn on the WiFi hotspot on the thermal device and then connect your phone to the hotspot.

- Hotspot Name: Wlan-<Serial No.>
- Hotspot Password: Last 9 digits of Serial Number of your thermal scope.

NOTE:

The device password is set by user at first activation. If the password was lost or forgotten, it can be reset. To reset a password perform the following steps:

1. When the thermal device is turned on, hold the MENU button  to activate the Main menu.
2. Select  Restore Factory Settings item in the General Settings menu and press the MENU button  to restore all parameters to default settings.

1. Run the app and connect the phone or tablet with the device.
2. If the device is inactivated, set the password and activate it. If the device is activated, enter the password to add it to the app.
3. When the device is added, the live view can be seen. You can view the interface of the device on the software. User can change such image parameters as brightness, contrast, zoom, palettes directly via phone or tablet as well as record video on phone/tablet memory.

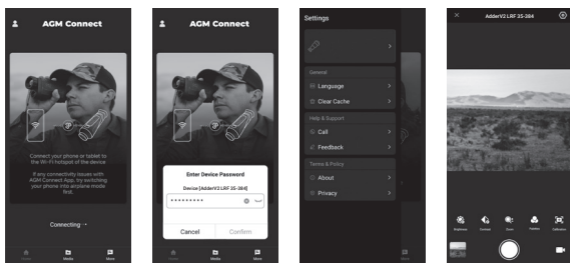

FIGURE 2-9. AGM CONNECT APP

3 MAINTENANCE

3.1 MAINTENANCE

3.1.1 CLEANING PROCEDURES

1. Gently brush off any dirt from the body of the device using a clean, soft cloth.
2. Moisten the cloth with fresh water and gently wipe down the external surfaces (except lenses).
3. Dry any wet surfaces (except lenses) using another dry, clean, soft cloth.
4. Using a lens brush, carefully remove all loose dirt from the lenses.
5. Use a high quality lens wipe to remove dirt or smudges from the lens and display window. Do not use abrasives or solvents to clean the housing, lens, or display window. Clean the glass surfaces using circular movements, starting from the center of the lens and moving out towards the edge.
6. Clean the accessories with a soft brush (or cloth) dampened with soap and water.

3.1.2 PREPARING FOR EXTENDED STORAGE

CAUTION:

Thoroughly dry each item before placing them into the storage case.

To prepare the rifle scope for extended storage:

1. Clean the rifle scope with a damp cloth to remove any dust, dirt or debris.
2. Remove the batteries.
3. Close the lens cap, and place items into their soft carrying case.

3.1.3 UPDATING THE DEVICE FIRMWARE

WARNING:

Please make sure the device is connected to the computer during the entire update process. Otherwise, it may cause unnecessary upgrade failure, firmware damage, etc.

1. Visit www.agmglobalvision.com/firmware website. Select your product, download the firmware update package to your PC and unzip it. Follow the detailed instructions on the website.
2. Connect the device to your PC with USB cable.
3. Turn on the device. Make sure the WiFi hotspot function is disabled.
4. Open the detected disk (USB drive) in file manager program. Copy the unzipped **digicap.dav** file and paste it to the root directory of the device.
5. Turn off the device completely, then power it back on. After awhile, the firmware update process will start automatically. During the update, the screen will display the inscription "Upgrading...". The update process will be completed when the inscription "Upgrading..." goes out.
6. Turn off the device and disconnect it from your PC.

You can also enjoy automatic update function in AGM Connect App (see section 2.3 for details).

1. Start the AGM Connect App and tap the Settings icon in the left top corner.
2. Tap your device in the device list. The information about your device will shown.
3. Tap **Checking for Upgrade** to detect and download the latest FW version.

3.2 TROUBLESHOOTING

Table 3-1 lists the most common malfunctions that may occur with your equipment. This table does not list all the malfunctions that may occur with your device. If the equipment malfunction is not corrected by the suggested actions, or a problem occurs that is not listed in this table, please contact AGM Global Vision's Customer Support center or your retailer.

TABLE 3-1. TROUBLESHOOTING

MALFUNCTION	CORRECTIVE ACTION
The scope fails to activate.	Charge the inner battery of the scope or install the charged additional 18650 battery.
The scope shut off sometimes after shot.	Low battery level. Check the remaining capacity of the battery, which may be low on power to maintain performance. Charge the inner battery of the scope or install the charged additional 18650 battery.
The image is not clear.	Perform the sight adjustment referring to section 2.1.
WiFi is not found.	Examine whether the WiFi function is turned on. If not, turn on the WiFi hotspot in the menu.
Capturing or recording fails.	<ol style="list-style-type: none">1. The device is connected to your PC and has disabled the capturing and recording. Disconnect the device.2. The storage space is full. Delete old files.3. The device is in a low-battery condition. Replace the battery.
The PC cannot identify the scope.	<ol style="list-style-type: none">1. The device is connected to your PC with standard USB cable. If you use other USB cables, make sure the cable length is no longer than 1 m.2. The WiFi function is turned on. If so, turn off the WiFi hotspot in the menu.

4 WARRANTY INFORMATION

4.1 WARRANTY INFORMATION AND REGISTRATION

The below description of AGM Global Vision warranty terms and conditions refer specifically to AGM branded products purchased within the United States. Customers purchasing AGM products outside the United States can obtain specific information about their product's warranty term on the www.agmglobalvision.eu website.

4.1.1 WARRANTY INFORMATION

This product is guaranteed to be free from manufacturing defects in material and workmanship under normal use for a period of five (5) years from the date of purchase. In the event that a defect covered by the warranty below occurs during the applicable period stated above, AGM Global Vision, at its discretion, will either repair or replace the product; such action on the part of AGM Global Vision shall be the full extent of AGM Global Vision's liability, and the Customer's sole and exclusive reparation. This warranty does not cover a product if it has been (a) used in ways other than its normal and customary manner; (b) subjected to misuse; (c) subjected to alterations, modifications or repairs by the Customer or by any party other than AGM Global Vision without prior written consent of AGM Global Vision; (d) is the result of a special order or categorized as "close-out" merchandise or merchandise sold "as-is" by either AGM Global Vision or the AGM Global Vision dealer; or (e) merchandise that has been discontinued by the manufacturer and either parts or replacement units are not available due to reasons beyond the control of AGM Global Vision. AGM Global Vision shall not be responsible for any defects or damage that in AGM Global Vision's view are a result from the mishandling, abuse, misuse, improper storage or improper operation of the device, including use in conjunction with equipment that is electrically or mechanically

incompatible with, or of inferior quality to, the product, as well as failure to maintain the environmental conditions specified by the manufacturer. This warranty is extended only to the original purchaser. Any breach of this warranty shall be enforced unless the customer notifies AGM Global Vision at the address noted below within the applicable warranty period.

The customer understands and agrees that except for the foregoing warranty, no other warranties written or oral, statutory, expressed or implied, including any implied warranty of merchantability or fitness for a particular purpose, shall apply to the product. All such implied warranties are hereby and expressly disclaimed.

4.1.2 LIMITATION OF LIABILITY

AGM Global Vision will not be liable for any claims, actions, suits, proceedings, costs, expenses, damages, or liabilities arising out of the use of this product. Operation and use of the product are the sole responsibility of the Customer. AGM Global Vision's sole undertaking is limited to providing the products and services outlined herein in accordance with the terms and conditions of this Agreement. The provision of products sold and services performed by AGM Global Vision to the Customer shall not be interpreted, construed, or regarded, either expressly or implied, as being for the benefit of or creating any obligation toward any third party of legal entity outside AGM Global Vision and the Customer; AGM Global Vision's obligations under this Agreement extend solely to the Customer. AGM Global Vision's liability hereunder for damages, regardless of the form or action, shall not exceed the fees or other charges paid to AGM Global Vision by the customer or customer's dealer. AGM Global Vision shall not, in any event, be liable for special, indirect, incidental, or consequential damages, including, but not limited to, lost income, lost revenue, or lost profit, whether such damages were foreseeable or not at the time of purchase, and whether or not such damages arise out of a breach of warranty, a breach of agreement, negligence, strict liability, or any other theory of liability.

4.1.3 PRODUCT REGISTRATION

In order to validate the warranty on your product, the customer must complete and submit AGM Global Vision PRODUCT REGISTRATION FORM on our website (www.agmglobalvision.com/customer-support).

4.1.4 OBTAINING WARRANTY SERVICE

To obtain warranty service on your unit, the End-user (Customer) must notify the AGM Global Vision service department via e-mail. Send any requests to support@agmglobalvision.com to receive a Return Merchandise Authorization number (RMA). When returning any device, please take the product to your retailer, or send the product, postage paid and with a copy of your sales receipt, to AGM Global Vision's service center at the address listed above. All merchandise must be fully insured with the correct postage; AGM Global Vision will not be responsible for improper postage or merchandise that becomes lost or damaged during shipment. When sending product back, please clearly write the RMA# on the outside of the shipping box. Please include a letter that indicates your RMA#, the Customer's Name, a Return Address, reason for the return, contact information (valid telephone numbers and/or an e-mail address), and proof of purchase that will help us to establish the valid start date of the warranty. Product merchandise returns that do not have an RMA# listed may be refused, or a significant delay in processing may occur. Estimated Warranty service time is 10-20 business days. The End-user/Customer is responsible for postage to AGM Global Vision for warranty service. AGM Global Vision will cover return postage/shipping after warranty repair to the End-user/Customer only if the product is covered by the aforementioned warranty. AGM Global Vision will return the product after warranty service by domestic UPS Ground service and/or domestic mail. Should any other requested, required, or international shipping methods be necessary, the postage/shipping fee will be the responsibility of the End-user/Customer.

For service, repair or replacement, please contact:

AGM Global Vision, LLC

2407 E Interstate 30, Suite 100

Grand Prairie, TX 75050, USA

Tel. 928.333.4300

support@agmglobalvision.com

www.agmglobalvision.com

5 SPECIFICATIONS

5.1 SPECIFICATIONS

	AdderV ² LRF 35-384	AdderV ² LRF 35-640
THERMAL MODULE		
Image Sensor	12µm VOx Uncooled Focal Plane Array	12µm VOx Uncooled Focal Plane Array
Resolution	384 × 288	640 × 512
Frame Rate	50 Hz	50 Hz
Response Waveband	8 µm to 14 µm	8 µm to 14 µm
NETD	Less than 15 mK (@25°C, F# = 1.0)	Less than 15 mK (@25°C, F# = 1.0)
Lens System	35 mm, F/1.0	35 mm, F/1.0
Field of View (H×V)	7.5° × 5.7° (13.1 m × 10.0 m)	12.5° × 10.0° (21.9 m × 17.5 m)
Magnification	4x – 24x	2.5x – 24x
Detection Range	1800 m	1800 m
Min. Focusing Distance	3 m	3 m
Focusing	Focus Ring	Focus Ring
IMAGE DISPLAY		
Display	2560 × 2560, 1.03-inch OLED	2560 × 2560, 1.03-inch OLED
Palettes	Black Hot, White Hot, Red Hot, Fusion, Red Monochrome, Green Monochrome	Black Hot, White Hot, Red Hot, Fusion, Red Monochrome, Green Monochrome
Exit Pupil	6 mm	6 mm
Eye Relief	45 mm	45 mm
Diopter Adjustment	-4D to 4D	-4D to 4D

	AdderV² LRF 35-384	AdderV² LRF 35-640
Digital Zoom	1x, 2x, 4x, 8x or continuous zoom in 0.5x increments	1x, 2x, 4x, 8x or continuous zoom in 0.5x increments
Brightness Adjustment	Yes	Yes
Contrast Adjustment	Yes	Yes
Sharpness Adjustment	Yes	Yes
Tone Adjustment	Cold, Warm	Cold, Warm
Zoom Pro	Yes	Yes
Image Boost 3.0	Yes	Yes
Shutterless Tech.	Yes	Yes
Flat Field Correction (FFC)	Semi-Auto, Manual	Semi-Auto, Manual
SYSTEM		
Record Video	Yes	Yes
Image Capture	Yes	Yes
Video Output	UVC screen casting (via USB Type-C)	UVC screen casting (via USB Type-C)
Audio Recording	Yes	Yes
Shot-Activated Recording (SAR)	Yes	Yes
Standby Mode	Yes	Yes
Storage	Built-in EMMC (64 GB)	Built-in EMMC (64 GB)
PIP	Yes	Yes
Hotspot	Yes	Yes
Hot Tracking	Yes	Yes
Distance Measurement	Yes (LRF)	Yes (LRF)
Zeroing Profiles	5	5
Freeze Zeroing	Yes	Yes
Ballistic Calculation	Yes	Yes
Reticle	10 types, 4 colors, on/off	10 types, 4 colors, on/off
Local Album	Yes	Yes

	AdderV ² LRF 35-384	AdderV ² LRF 35-640
POWER SUPPLY		
Battery Type	Built-in rechargeable Li-Ion battery and one additional replaceable rechargeable 18650 battery (two replaceable 18650 batteries included)	Built-in rechargeable Li-Ion battery and one additional replaceable rechargeable 18650 battery (two replaceable 18650 batteries included)
Battery Life (operating)	9 hours (@25°C, LRF on)	9 hours (@25°C, LRF on)
Power Supply	5 V DC/3 A, 9 V DC/2A, 12 V DC/1.5A, USB Type-C interface (supports QC3.0)	5 V DC/3 A, 9 V DC/2A, 12 V DC/1.5A, USB Type-C interface (supports QC3.0)
GENERAL		
Protection Level	IP67	IP67
Operating Temperature	-30°C to 55°C (-22°F to 131°F)	-30°C to 55°C (-22°F to 131°F)
Max. Recoil	1000 g/0.4 ms	1000 g/0.4 ms
Mounting	30 mm Rings	30 mm Rings
Centerline Height	37.3 mm (1.47 in)	37.3 mm (1.47 in)
Dimensions (w/o mount)	420 × 88 × 74 mm (16.5 × 3.4 × 2.9 in)	410 × 85 × 84 mm (16.1 × 3.3 × 3.3 in)
Weight (w/o mount)	0.88 kg / 1.94 lb	0.88 kg / 1.94 lb
LASER RANGEFINDER		
LRF Module in Lens	No	No
Safety Class for Laser	Class 1	Class 1
Wavelength	905 nm	905 nm
Max. Measuring Range	1000 m	1000 m
Measurement Accuracy	±1 m	±1 m
Min. Measuring Range	10 m	10 m

	AdderV ² LRF 50-640	AdderV ² LRF 60-1280
THERMAL MODULE		
Image Sensor	12µm VOx Uncooled Focal Plane Array	12µm VOx Uncooled Focal Plane Array
Resolution	640 × 512	1280 × 1024
Frame Rate	50 Hz	25 Hz
Response Waveband	8 µm to 14 µm	8 µm to 14 µm
NETD	Less than 15 mK (@25°C, F# = 1.0)	Less than 18 mK (@25°C, F# = 1.0)
Lens System	50 mm, F/1.0	60 mm, F/1.0
Field of View(H×V)	8.8° × 7.0° (15.4 m × 12.3 m)	14.6° × 11.7° (25.6 m × 20.5 m)
Magnification	3.5x – 26x	2.5x – 28x
Detection Range	2600 m	3100 m
Min. Focusing Distance	5 m	6 m
Focusing	Focus Ring	Focus Ring
IMAGE DISPLAY		
Display	2560 × 2560, 1.03-inch OLED	2560 × 2560, 1.03-inch OLED
Palettes	Black Hot, White Hot, Red Hot, Fusion, Red Monochrome, Green Monochrome	Black Hot, White Hot, Red Hot, Fusion, Red Monochrome, Green Monochrome
Exit Pupil	6 mm	6 mm
Eye Relief	45 mm	45 mm
Diopter Adjustment	-4D to 4D	-4D to 4D
Digital Zoom	1x, 2x, 4x, 8x or continuous zoom in 0.5x increments	1x, 2x, 4x, 8x or continuous zoom in 0.5x increments
Brightness Adjustment	Yes	Yes
Contrast Adjustment	Yes	Yes
Sharpness Adjustment	Yes	Yes
Tone Adjustment	Cold, Warm	Cold, Warm
Zoom Pro	Yes	No

	AdderV ² LRF 50-640	AdderV ² LRF 60-1280
Image Boost 3.0	Yes	Yes
Shutterless Tech.	Yes	No
Flat Field Correction (FFC)	Semi-Auto, Manual	Auto, Semi-Auto, Manual
SYSTEM		
Record Video	Yes	Yes
Image Capture	Yes	Yes
Audio Recording	Yes	Yes
Shot-Activated Recording (SAR)	Yes	Yes
Standby Mode	Yes	Yes
Storage	Built-in EMMC (64 GB)	Built-in EMMC (64 GB)
PIP	Yes	Yes
Hotspot	Yes	Yes
Hot Tracking	Yes	Yes
Distance Measurement	Yes (LRF)	Yes (LRF)
Zeroing Profiles	5	5
Freeze Zeroing	Yes	Yes
Ballistic Calculation	Yes	Yes
Reticle	10 types, 4 colors, on/off	10 types, 4 colors, on/off
Local Album	Yes	Yes
POWER SUPPLY		
Battery Type	Built-in rechargeable Li-Ion battery and one additional replaceable rechargeable 18650 battery (two replaceable 18650 batteries included)	Built-in rechargeable Li-Ion battery and one additional replaceable rechargeable 18650 battery (two replaceable 18650 batteries included)
Battery Life (operating)	9 hours (@25°C, LRF on)	9 hours (@25°C, LRF on)

	AdderV ² LRF 50-640	AdderV ² LRF 60-1280
Power Supply	5 V DC/3 A, 9 V DC/2A, 12 V DC/1.5A, USB Type-C interface (supports QC3.0)	5 V DC/3 A, 9 V DC/2A, 12 V DC/1.5A, USB Type-C interface (supports QC3.0)
GENERAL		
Protection Level	IP67	IP67
Operating Temperature	-30°C to 55°C (-22°F to 131°F)	-30°C to 55°C (-22°F to 131°F)
Max. Recoil	1000 g/0.4 ms	1000 g/0.4 ms
Mounting	30 mm Rings	30 mm Rings
Centerline Height	37.3 mm (1.47 in)	41 mm (1.6 in)
Dimensions (w/o mount)	420 × 88 × 74 mm (16.5 × 3.4 × 2.9 in)	450 × 94 × 79 mm (17.7 × 3.7 × 3.1 in)
Weight (w/o mount)	0.88 kg / 1.94 lb	1.0 kg / 2.2 lb
LASER RANGEFINDER		
LRF Module in Lens	Yes	Yes
Safety Class for Laser	Class 1	Class 1
Wavelength	905 nm	905 nm
Max. Measuring Range	1000 m	1000 m
Measurement Accuracy	±1 m	±1 m
Min. Measuring Range	10 m	10 m

**All data subject to change without notice.*

5.2 RETICLE PARAMETERS

IMAGE	ITEM	MOA	CM @100 M	IN @100 YD
	AdderV² LRF 35-384			
	A	88.6	257.8	92.8
	B	88.6	257.8	92.8
	C	3.4	9.9	3.6
	D	21.5	62.5	22.5
	E	6.4	18.7	6.7
	AdderV² LRF 35-640			
	A	160.3	466.3	167.8
	B	160.3	466.3	167.8
	C	5.7	16.5	5.9
	D	35.8	104.2	37.5
	E	10.7	31.1	11.2
	AdderV² LRF 50-640			
	A	112.2	326.4	117.5
	B	112.2	326.4	117.5
	C	4.0	11.5	4.1
	D	25.1	73.0	26.3
	E	7.5	21.8	7.8
	AdderV² LRF 60-1280			
	A	187.0	544.0	195.8
	B	188.3	548.0	197.2
	C	6.2	18.0	6.5
	D	39.2	114.0	41.0
	E	11.7	34.0	12.2

IMAGE	ITEM	MOA	CM @100 M	IN @100 YD
	Adder V² LRF 35-384			
	A	113.1	329.1	118.5
	B	104.8	305.0	109.8
	C	3.4	9.9	3.6
	Adder V² LRF 35-640			
	A	201.1	585.1	210.6
	B	187.3	544.9	196.1
	C	5.7	16.5	5.9
	Adder V² LRF 50-640			
	A	140.8	409.6	147.4
	B	131.1	381.4	137.3
	C	4.0	11.5	4.1
	Adder V² LRF 60-1280			
	A	233.7	680.0	244.7
	B	218.6	636.0	228.8
	C	6.2	18.0	6.5
	Adder V² LRF 35-384			
	A	113.1	329.1	118.5
	B	105.2	306.1	110.2
	C	3.4	9.9	3.6
	Adder V² LRF 35-640			
	A	201.1	585.1	210.6
	B	187.9	546.7	196.7
	C	5.7	16.5	5.9
	Adder V² LRF 50-640			
	A	140.8	409.6	147.4
	B	131.6	382.7	137.7
	C	4.0	11.5	4.1
	Adder V² LRF 60-1280			
	A	233.7	680.0	244.7
	B	219.3	638.0	229.6
	C	6.2	18.0	6.5

IMAGE	ITEM	MOA	CM @100 M	IN @100 YD
	Adder V² LRF 35-384			
	A	81.5	237.0	85.3
	B	72.0	209.6	75.4
	C	24.2	70.4	25.3
	D	4.1	12.1	4.3
	E	29.4	85.5	30.8
	F	2.6	7.7	2.8
	G	6.7	19.6	7.1
	H	6.7	19.6	7.1
	I	3.4	9.9	3.6
	J	4.5	13.2	4.7
	K	3.0	8.8	3.1
	Adder V² LRF 35-640			
	A	148.3	431.5	155.3
	B	148.3	431.5	155.3
	C	40.4	117.5	42.3
	D	6.9	20.1	7.2
	E	49.0	142.5	51.3
	F	4.4	12.8	4.6
	G	6.7	19.6	7.1
	H	6.7	19.6	7.1
	I	5.7	16.5	5.9
	J	7.5	21.9	7.9
K	5.0	14.6	5.2	

IMAGE	ITEM	MOA	CM @100 M	IN @100 YD
	RETICLE 4			
	AdderV² LRF 50-640			
	A	103.8	302.1	108.7
	B	103.8	302.1	108.7
	C	28.1	81.7	29.4
	D	4.8	14.1	5.1
	E	34.4	100.1	36.0
	F	3.1	9.0	3.2
	G	6.7	19.6	7.1
	H	6.7	19.6	7.1
	I	4.0	11.5	4.1
	J	5.3	15.4	5.5
	K	3.5	10.2	3.7
	AdderV² LRF 60-1280			
	A	176.7	514.0	185.0
	B	159.5	464.0	167.0
	C	44.0	128.0	46.1
	D	7.6	22.0	7.9
	E	53.7	156.2	56.2
	F	4.8	14.0	5.0
	G	6.7	19.6	7.1
	H	6.7	19.6	7.1
	I	6.2	18.0	6.5
	J	8.3	24.1	8.7
	K	5.5	16.0	5.8

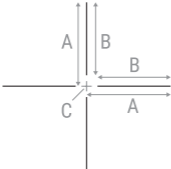
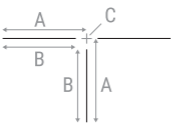
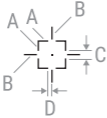

IMAGE	ITEM	MOA	CM @100 M	IN @100 YD
	Adder V² LRF 35-384			
	A	3.4	9.9	3.6
	B	3.4	9.9	3.6
	C	2.6	7.6	2.7
	D	1.1	3.3	1.2
	Adder V² LRF 35-640			
	A	5.7	16.5	5.9
	B	5.7	16.5	5.9
	C	3.1	9.0	3.2
	D	1.3	3.7	1.3
	Adder V² LRF 50-640			
	A	4.0	11.5	4.1
	B	4.0	11.5	4.1
	C	1.3	3.8	1.4
	D	0.9	2.6	0.9
	Adder V² LRF 60-1280			
	A	6.2	18.0	6.5
	B	6.2	18.0	6.5
	C	4.8	14.0	5.0
	D	2.1	6.0	2.2
RETICLE 6	Adder V² LRF 35-384			
	A	6.4	18.7	6.7
	B	1.1	3.3	1.2
	Adder V² LRF 35-640			
	A	10.7	31.1	11.2
	B	1.9	5.5	2.0
	Adder V² LRF 50-640			
	A	7.5	21.8	7.8
	B	1.3	3.8	1.4
	Adder V² LRF 60-1280			
	A	11.7	34.0	12.2
B	2.1	6.0	2.2	

IMAGE	ITEM	MOA	CM @100 M	IN @100 YD
	Adder V² LRF 35-384			
	A	109.4	318.2	114.5
	B	86.0	250.1	90.0
	C	24.5	71.3	25.7
	D	3.4	9.9	3.6
	E	2.6	7.7	2.8
	F	3.0	8.8	3.1
	G	4.5	13.2	4.7
	H	3.4	10.0	3.6
	I	5.3	15.3	5.5
	J	8.0	23.3	8.4
	Adder V² LRF 35-640			
	A	194.8	566.9	204.0
	B	155.9	453.5	163.2
	C	40.9	118.9	42.8
	D	5.7	16.5	5.9
	E	4.4	12.8	4.6
	F	5.0	14.6	5.2
	G	7.5	21.9	7.9
	H	3.4	10.0	3.6
	I	5.3	15.3	5.5
	J	8.0	23.3	8.4

IMAGE	ITEM	MOA	CM @100 M	IN @100 YD
	Adder V² LRF 50-640			
	A	136.4	396.8	142.8
	B	109.1	317.4	114.2
	C	28.6	83.2	29.9
	D	4.0	11.5	4.1
	E	3.1	9.0	3.2
	F	3.5	10.2	3.7
	G	5.3	15.4	5.5
	H	3.4	10.0	3.6
	I	5.3	15.3	5.5
	J	8.0	23.3	8.4
	Adder V² LRF 60-1280			
	A	227.5	662.0	238.2
	B	184.9	538.0	193.6
	C	44.7	130.0	46.8
	D	6.2	18.0	6.5
	E	4.8	14.0	5.0
	F	5.5	16.0	5.8
	G	8.3	24.0	8.6
	H	3.4	10.0	3.6
	I	5.3	15.3	5.5
	J	8.0	23.3	8.4

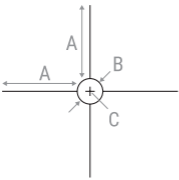
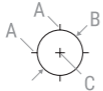

IMAGE	ITEM	MOA	CM @100 M	IN @100 YD	
	Adder V² LRF 35-384				
	A	99.2	288.5	103.9	
	B	35.1	103.5	36.7	
	C	3.4	9.9	3.6	
	Adder V² LRF 35-640				
	A	177.9	517.5	186.2	
	B	45.3	131.7	47.4	
	C	5.7	16.5	5.9	
	Adder V² LRF 50-640				
	A	124.5	362.2	130.4	
	B	31.7	92.2	33.2	
	C	4.0	11.5	4.1	
	Adder V² LRF 60-1280				
	A	209.0	608.0	218.8	
	B	50.2	146.0	52.5	
	C	6.2	18.0	6.5	
	RETICLE 9	Adder V² LRF 35-384			
		A	3.4	9.9	3.6
B		27.5	80.1	28.8	
C		3.4	9.9	3.6	
Adder V² LRF 35-640					
A		5.0	14.6	5.3	
B		45.3	131.7	47.4	
C		5.7	16.5	5.9	
Adder V² LRF 50-640					
A		3.5	10.2	3.7	
B		31.7	92.2	33.2	
C		4.0	11.5	4.1	
Adder V² LRF 60-1280					
A		6.2	18.0	6.5	
B		50.2	146.0	52.5	
C		6.2	18.0	6.5	

IMAGE	ITEM	MOA	CM @100 M	IN @100 YD
	Adder V² LRF 35-384			
	A	4.9	14.3	5.1
	Adder V² LRF 35-640			
	A	8.2	23.8	8.6
	Adder V² LRF 50-640			
	A	8.2	23.8	8.6
Adder V² LRF 60-1280				
A	8.9	26.0	9.4	

All data subject to change without notice.

NOTE:

The scale intervals of the Reticle 4 and Reticle 7 change synchronously under the current digital zoom.



AGM Global Vision, LLC

MAIN OFFICE

2407 E Interstate 30,

Suite 100

Grand Prairie, TX 75050

USA

Tel. +1.928.333.4300

info@agmglobalvision.com

www.agmglobalvision.com

EUROPEAN OFFICE

#6 Andrey Lyapchev Blvd

Sofia, P.C. 1756

Bulgaria

Tel. +35.988.560.0326

info@agmglobalvision.eu

www.agmglobalvision.eu

DOWNLOAD AGM CONNECT APP:



Google Play Store



Apple App Store

AGMglobalvision.com