

VARMINT V² LRF

THERMAL IMAGING RIFLE SCOPE
WITH LASER RANGEFINDER

USER MANUAL

© 2024 AGM Global Vision, LLC. All rights reserved.

This documentation is subject to change without notice.

No parts of this manual, in whole or in part, may be copied, photocopied, translated, or transmitted by any electronic medium or in machine-readable form without the prior written permission of AGM Global Vision, LLC.

Approved for public release, distribution unlimited.

If you have questions that are not covered in this manual, or need service, contact AGM Global Vision customer support for additional information prior to returning a product.

AGM Global Vision, LLC

2407 E Interstate 30, Suite 100

Grand Prairie, TX 75050

Tel. 928.333.4300

support@agmglobalvision.com

www.agmglobalvision.com

EXPORT INFORMATION

Buyer acknowledges that all products supplied by AGM Global Vision, LLC are subject to U.S. export control laws, including, but not limited to, the Export Administration Regulations, the International Traffic in Arms Regulations, the International Economic Emergency Powers Act, and various U.S. embargoes and sanctions. AGM Global Vision products may not be exported, re-exported, or transferred contrary to U.S. export control laws. In particular, AGM Global Vision products may not be exported, re-exported, or transferred to prohibited countries, individuals, organizations, or entities, including but not limited to those individuals and entities listed on the List of Specially Designated Nationals and Blocked Persons administered or maintained by the U.S. Office of Foreign Assets Control ("OFAC"), the various lists maintained by the Bureau of Industry and Security of the Department of Commerce, and the U.S. State Department and Buyer represents and warrants that neither Buyer nor any of its officers, directors, or employees are on such lists. Distribution or resale by Buyer to such countries, individuals, organizations, or entities is expressly prohibited. Buyer has and will maintain a positive process to ensure compliance with this Section.

FCC INFORMATION

Please note that changes or modification not expressly approved by the party responsible for compliance could void the user's authority to operate the equipment.

This equipment complies with FCC/IC RSS-102 radiation exposure limits set forth for an uncontrolled environment.



FCC compliance: This product has been tested and found to comply with the limits for a Class B digital device, pursuant to Part 15 of the FCC Rules. These limits are designed to provide reasonable protection against harmful interference in a residential installation. This product generates, uses, and can radiate radio frequency energy and, if not installed and used in accordance with the instructions, may cause harmful interference to radio communications. However, there is no guarantee that interference will not occur in a particular installation. If this product does cause harmful interference to radio or television reception, which can be determined by turning the equipment off and on, the user is encouraged to try to correct the interference by one or more of the following measures:

- Reorient or relocate the receiving antenna.
- Increase the separation between the equipment and receiver.
- Connect the equipment into an outlet on a circuit different from that to which the receiver is connected.
- Consult the dealer or an experienced radio/TV technician for help.

FCC Conditions

This device complies with part 15 of the FCC Rules. Operation is subject to the following two conditions:

1. This device may not cause harmful interference.
2. This device must accept any interference received, including interference that may cause undesired operation.

EU CONFORMITY STATEMENT



This product and - if applicable - the supplied accessories too are marked with "CE" and comply therefore with the applicable harmonized European standards listed under the EMC Directive 2014/30/EU, the RoHS Directive 2011/65/EU



2012/19/EU (WEEE directive): Products marked with this symbol cannot be disposed of as unsorted municipal waste in the European Union. For proper recycling, return this product to your local supplier upon the purchase of equivalent new equipment, or dispose of it at designated collection points. For more information see: www.recyclethis.info



Regulation (EU) 2023/1542 (Battery Regulation): This product contains a battery and it is in conformity with the Regulation (EU) 2023/1542. The battery cannot be disposed of as unsorted municipal waste in the European Union. See the product documentation for specific battery information. The battery is marked with this symbol, which may include lettering to indicate cadmium (Cd), or lead (Pb). For proper recycling, return the battery to your supplier or to a designated collection point. For more information see: www.recyclethis.info.

LIST OF CONTENTS

TITLE	PAGE
Safety Summary	5
1. GENERAL INFORMATION	8
1.1 System Description	8
1.2 Key Features	9
2. OPERATING INSTRUCTIONS	10
2.1. Basic Operations	10
2.2 Main Function	16
2.3 Client Software Introduction	30
3. MAINTENANCE	31
3.1 Maintenance	31
3.2 Troubleshooting	32
4. WARRANTY INFORMATION	33
4.1 Warranty Information and Registration	33
5. SPECIFICATIONS	35
5.1 Specifications	35
5.2 Reticle Parameters	37

SAFETY SUMMARY

- Read and follow all instructions
- Read all warnings
- Only use the attachments/accessories specified by the manufacturer
- All service must be provided by the manufacturer

WARNINGS:

- **This product contains natural rubber latex, which may have the potential to cause allergic reactions. If you are allergic to latex, it is important that you strictly avoid exposure to products that contain it.**
- Always make sure your firearm is unloaded before you place the optic on the firearm. Reconfirm that the chamber is empty if you are forced to stop at anytime before completing the zeroing in process. Safe handling rules should be followed at all times.
- If a scope is mounted too far to the rear, the eyepiece may cause an impact injury to the shooter's eye socket. Shooting at an uphill angle also increases this hazard because it shortens the distance between the eyebrow and the rear of the scope. For this reason, AGM scopes are engineered to provide generous eye relief. Therefore, when mounting your scope, we recommend positioning it as far forward in the mounts as possible to take full advantage of this generous eye relief. With hard-recoiling rifles, serious injury or even death can result from eyepiece impact with the shooter during the recoil process when discharging the firearm. Be certain that your installation provides sufficient eye relief for the recoil generated by your rifle before shooting the firearm.

NOTE:

Give special attention to this warning when shooting uphill and/or from a prone position. These shooting conditions can dramatically reduce eye relief. PLEASE maintain maximum eye relief when shooting heavy recoiling and/or magnum firearms. THE USER ASSUMES ALL RESPONSIBILITY AND LIABILITY FOR HAVING THE AGM RIFLE SCOPE PROPERLY MOUNTED TO A FIREARM AND USING THE AGM RIFLE SCOPE PROPERLY. ALWAYS CHECK THE CONDITION OF YOUR MOUNTING SYSTEM PRIOR TO USING YOUR FIREARM.

SAFETY INSTRUCTIONS:

Transportation

- Keep the device in original or similar packaging while transporting it.
- Keep all wrappers after unpacking them for future use. In case of any failure occurred, you need to return the device to the factory with the original wrapper. Transportation without the original wrapper may result in damage on the device and the company shall not take any responsibilities.
- Do not drop the product or subject it to physical shock. Keep the device away from magnetic interference.

Power Supply

- If a power adapter is provided in the device package, use the provided adapter only. If no power adapter is provided, ensure the power adapter or other power supply complies with Limited Power Source (5 VDC/2 A). Refer to the product label for the power supply output parameters.
- Make sure the plug is properly connected to the power socket.
- DO NOT connect multiple devices to one power adapter, to avoid overheating or fire hazards caused by overload.

Battery

- The device supports removable and rechargeable 18650 Li-Ion battery. The external battery size should be 19×70 mm. The battery voltage and capacity is 3.6V/3.2Ah (11.52 Wh).
- The purchased batteries by users need to comply with the relevant international standards about battery safety (e.g. EN/IEC standards).
- Improper use or replacement of the battery may result in explosion hazard. Replace with the same or equivalent type only.
- Batteries of improper size cannot be installed, and may cause abnormal shutdown.
- Dispose of used batteries in conformance with the instructions provided by the battery manufacturer.
- Make sure the battery temperature is between 0°C to 45°C (32°F to 113°F) when charging.
- For long-term storage of the battery, make sure it is fully charged every half year to ensure the battery quality. Otherwise, damage may occur.
- Do not charge other battery types with the supplied charger. Confirm there is no flammable material within 2 m of the charger during charging.
- Do not dispose of the battery into fire or a hot oven, or mechanically crush or cut the battery, which may result in an explosion.
- Do not leave the battery in an extremely high temperature or low air pressure environment, which may result in an explosion or the leakage of flammable liquid or gas.
- DO NOT place the device with battery or the battery alone near heating or fire source. Avoid direct sunlight.
- If the battery compartment does not close securely, stop using the product and keep it away from children.
- DO NOT disassemble the battery.
- DO NOT place the battery in the reach of children.
- This device is not suitable for use in locations where children are likely to be present.

Maintenance

- If the product does not work properly, please contact your dealer or the nearest service center. We shall not assume any responsibility for problems caused by unauthorized repair or maintenance.
- Make sure that the power has been disconnected before device teardown and repair by professionals.

- Wipe the device gently with a clean cloth and a small quantity of ethanol, if necessary.
- If the equipment is used in a manner not specified by the manufacturer, the protection provided by the device may be impaired.
- Clean the lens with soft and dry cloth or wiping paper to avoid scratching it.

Using Environment

- Make sure the running environment meets the requirement of the device. The operating temperature shall be -30°C to 55°C (-22°F to 131°F), and the operating humidity shall be from 5% to 95%.
- DO NOT expose the device to high electromagnetic radiation or dusty environments.
- DO NOT aim the lens at the sun or any other bright light.
- Place the device in a dry and well-ventilated environment.
- Avoid equipment installation on vibratory surface.
- When any laser equipment is in use, make sure that the device lens is not exposed to the laser beam, or it may burn out.
- This equipment is not suitable for use in locations where children are likely to be present.

NOTES:

- The detector spectral band provides better visibility through smoke, dust, rain, smog, etc.
- Infrared radiation does not travel through glass. As a result, the rifle scope does not detect objects if they are behind glass windows or other barriers.

LASER CAUTION:

When any laser equipment is in use, make sure that the device lens is not exposed to the laser beam, or it may burn out. The laser radiation emitted from the device can cause eye injuries, burning of skin or inflammable substances. Before enabling the light supplement function, make sure no human or inflammable substances are in front of the laser lens. Do not place the device where minors can fetch it. According to IEC 60825 1:2014, EN 60825 1:2014+A11:2021, and EN 50689:2021, this laser product is classified as Class 1 laser product and consumer laser product.

Complies with FDA performance standards for laser products except for conformance with IEC 60825-1 Ed. 3., as described in Laser Notice No.56, dated May 8, 2019.



1 GENERAL INFORMATION

1.1 SYSTEM DESCRIPTION

The VarmintV² LRF series of thermal riflescopes from AGM utilize many of the features that shooters have come to know and love in the ever-popular Rattler product family, but with one big addition: a 600-meter integrated laser rangefinder (LRF). The LRF functionality pairs with a 12 micron sub-20 millikelvin thermal detector, which works in conjunction with a high quality 1024x768 OLED display. The VarmintV² LRF scopes are powered by a single 18650 rechargeable battery, which provides users with over 5 hours of continuous use in the field. The compact design of the VarmintV² LRF even allows some dual-use functionality as a handheld monocular as well, which helps in surveying your surroundings. Pairing all these physical aspects with built-in recording, Wi-Fi compatibility through the AGM Connect app, external power options through the mini USB port, multiple reticle options, various color palettes, and 16GB of internal storage capacity, make the VarmintV² LRF one of the most functional products in the AGM family.

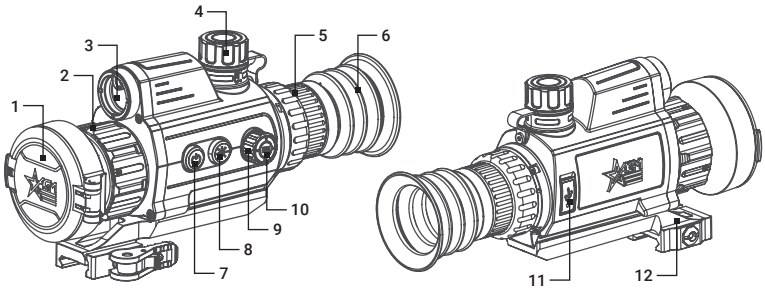

FIGURE 1-1. MAIN PARTS

TABLE 1-1. MAIN PARTS

ITEM	DESCRIPTION
1	Lens Cap
2	Focus Ring
3	Laser Range Finder
4	Battery Compartment
5	Diopter Adjustment Ring
6	Eyecup

ITEM	DESCRIPTION
7	Power Button
8	LRF Button
9	Navigation Wheel
10	Menu Button
11	USB Type-C Interface
12	Mount

1.2 STANDARD COMPONENTS

The standard components are shown in Figure 1-2 and listed in Table 1-2. The ITEM column indicates the number used to identify items in Figure 1-2.

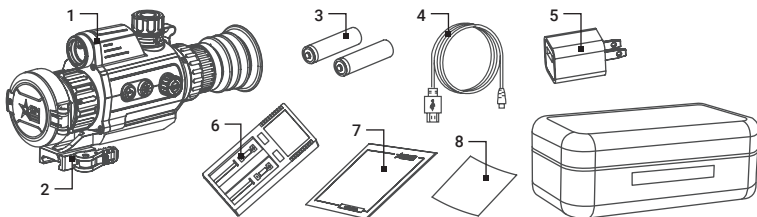

FIGURE 1-2. STANDARD COMPONENTS

TABLE 1-2. STANDARD COMPONENTS

ITEM	DESCRIPTION	QUANTITY
1	Rifle scope	1
2	Mount (type may vary)	1
3	18650 Rechargeable Battery	2
4	USB Cable	1
5	Power Adapter	1
6	Battery Charger	1
7	User Manual	1
8	Lens Cloth	1
9	Carrying Case	1

1.3 KEY FEATURES

- 12 μ m high-sensitivity thermal detector, NETD<20mK
- Fast 50 Hz imaging
- Built-in laser rangefinder
- Up to 8x digital zoom in 0.5x increment
- High resolution OLED display
- Adjustable color palettes
- Ballistic calculator
- Various reticle types and colors
- One shot zero correction
- On-board video recording and image capture
- Shot Activated Recording (SAR)
- Built-in EMMC storage (16 GB)
- Wi-Fi data transmission
- Standby mode
- Up to 6 hours of battery life (depending on model)
- External power supply compatibility
- Waterproof & shockproof

2 OPERATING INSTRUCTIONS

2.1. BASIC OPERATIONS

2.1.1 UNPACKING

The following steps must be completed prior to each mission.

1. Open the carrying case, remove the device, and verify that all components are included.
2. Inspect the device for any obvious evidence of damage to the optical surfaces, body, eyecup, operation buttons, etc. Ensure that all optical surfaces are clean and ready for use. Clean all optical surfaces with a lens tissue.

2.1.2 BATTERY INSTALLATION

CAUTION:

Verify that the device is turned off before removing the battery.

1. Turn the battery cover (A) counterclockwise to open it.
2. Make sure the 18650 battery is fully charged. Insert the battery (B) into the battery compartment (C) with the positive mark inward.
3. Turn the battery cover clockwise to tighten it.

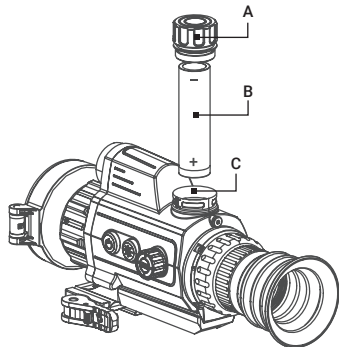

FIGURE 2-1. BATTERY INSTALLATION

NOTE:

Remove the battery from the battery compartment if the device is not used for a long time.

2.1.3 CONTROL BUTTONS

The VarmintV² LRF controls are shown in Figure 2-2 and are defined in Table 2-1.

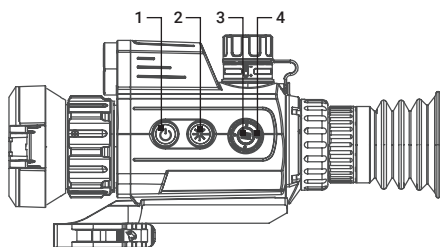





FIGURE 2-2. VARMINT V² LRF CONTROLS



Each button is responsible for some functions selected by short press or long press (hold) the button. Pushing a button for 2+ second is considered “long press” (hold).

TABLE 2-1. VARMINT V² LRF CONTROL FUNCTIONS

ITEM	CONTROLS	FUNCTIONS
1	 POWER BUTTON	Press: Standby mode / Wake up device. Hold: Power ON/OFF.
2	 LRF BUTTON	Press once: Turning on the laser / Distance measurement. Press twice: Turning off the laser. Hold: Start / Stop video recording.
3	 MENU BUTTON	Press: Switch palettes. Hold: Enter Main Menu / Exit menu.
4	NAVIGATION WHEEL	Rotate: Setting the magnification. Menu Mode: Navigation menu.
1 + 2	POWER BUTTON + LRF BUTTON	Press: Manual FFC (image calibration).
2 + 3	LRF BUTTON + MENU BUTTON	Press: Capture snapshot.

NOTE:

Press the POWER button  and LRF button  at the same time to correct the non-uniformity of display manually (manual FFC).



Press the LRF button  and MENU button  at the same time to capture snapshot.

2.1.4 POWER ON AND OFF

Power On

With the battery installed, press and hold the POWER button  to turn on the device. The LED power indicator in the POWER button will light up.

NOTE

See the battery icon on the device display to check the battery charge. Icon  means the battery is fully charged, and icon  means that the battery is low. When the low power note shows, replace the battery.

Power Off

When the device is turned on, hold the POWER button  to turn off the device.



Auto Power Off

In the “Auto Power Off” submenu of General Settings you can set the time for the automatic shutdown of the device as required (see 2.2.27 for details).

The Auto Power Off countdown will start again when the device exits standby mode, or the device is restarted.

2.1.5 STANDBY MODE

Standby mode is used to save battery power. In this mode, some power-consuming features such as the display, network hardware, or internal storage will be temporarily disabled.

In the view mode, press the POWER button . After a few seconds, the display will turn off. Press the POWER button  again to exit the Standby mode.

2.1.6 VIEWING THE THERMAL IMAGE

1. Power on the rifle scope.
2. Bring the scope to your eye and make sure the eyecup covers your eye.
3. Use the diopter adjustment ring (rotating ring closest to your eye) to ensure that the on-screen interface elements are crisp and sharp. Once completed, this adjustment will not be needed again until a new user is using the device.
4. Once the diopter is adjusted, all image focusing for various distances will occur only using the lens focusing ring.

NOTE:

You must perform the focus adjustment before any further use of the scope.

5. Set palette, brightness, contrast, image tone, sharpness, scene mode and FFC (Flat Field Correction), to display the best image effect.

2.1.7 ON-SCREEN DISPLAY (OSD)

On-screen interface displays the menu items and device status indicators.

Press the MENU button  in live view interface to call the Quick Menu.

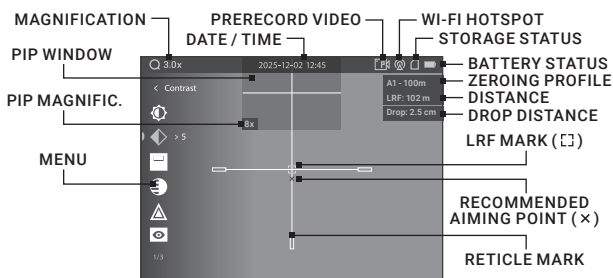



FIGURE 2-3. ON-SCREEN DISPLAY

Hold the MENU button  in the view mode to display or hide the Main Menu. Adjust the OSD in the Function Settings menu. When OSD is on, the information of Wi-Fi hotspot activation, magnification, storage memory status, battery status, time and date displays on the screen.

2.1.8 DIGITAL ZOOM

In the live view mode, rotate the navigation wheel to switch the digital zoom of the device. The magnification will change continuously in 0.5X steps. The image magnification value is displayed at the top of the screen.

The PIP window at the top of the screen displays the details of central part of the image. When you change the zoom level, the current PIP magnification is displayed in the corner of the PIP window.

NOTE:

- When the reticle is enabled, the PIP view displays a magnified area around the center of the crosshair. When the reticle is not enabled, the PIP view displays a magnified central area of the image.
- If the PIP function is activated, the image will be enlarged by the zoom factor only in the PIP window.

2.1.9 PALETTE SETTINGS



You can select different palettes to display the same scene in different effects. In the live view mode, press the MENU button  to select the image color palette.

TABLE 2-2. PALETTE SETTINGS

PALETTE	DESCRIPTION
WHITE HOT	The hot part is displayed in white. The higher the temperature, the lighter the color.
BLACK HOT	The hot part is displayed in black. The higher the temperature, the darker the color.
FUSION	The hot part is displayed in white. From high temperature to low temperature, the image is colored in from white, yellow, red, pink to purple.
RED HOT	The hottest part is displayed in red, the rest of the image will be flushed out in shades of gray.

2.1.10 DISTANCE MEASUREMENT

The device can detect the distance between the target and the observation position with built-in laser rangefinder.

Make the laser rangefinder settings in the menu (see details in part 2.2.13). Point the square mark of the rangefinder at the target and press the LRF button  to measure the distance to the target. The distance measurement result is displayed at the upper right of the image.

2.1.11 IMAGE CALIBRATION

Press the POWER button  and LRF button  at the same time to release the shutter once for correction of the non-uniformity of display. See part 2.2.20 for more details.



2.1.12 VIDEO RECORDING / IMAGE CAPTURE

Video Recording

In the live view interface press and hold the LRF button  to start/stop recording.

The left top of image displays the information of recording time.

Image Capture

In the live view interface, press the LRF button  and MENU button  at the same time to capture the image.

NOTE:

- When capturing succeeds, the image freezes for 1 second and a prompt shows on the display.
- For exporting captured pictures, refer to File Export.

2.1.13 CONNECTING THE DEVICE

1. Open the USB interface cover.
2. Connect the device and power adapter with a Type-C cable to power on the device. Alternatively, connect the device and PC to copy/delete files.

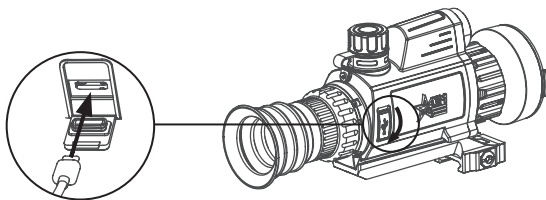

FIGURE 2-4. CABLE INTERFACE

2.1.14 FILE EXPORT

1. Before connecting the thermal rifle scope to a computer, please make sure that the Wi-Fi function of the rifle scope is disabled.
2. Connect the thermal rifle scope to your PC with USB cable and open the detected disk.
3. The directory is named by the current date. Enter **AGM Content** > **"Date"** to view the videos and snapshots.
 - Select and copy the videos to PC and play the file with the player.
 - Select and copy the snapshots to PC and view the files.
4. Disconnect the device from your PC.

NOTE:

- The device displays images when you connect it to PC. But functions such as recording, capturing and hot spot are disabled.
- When you connect the device to PC for the first time, it installs the drive program automatically.

2.1.15 INSTALLING THE VARMINT ON A PICATINNY/WEAVER RAIL

WARNING:

Always make sure your firearm is unloaded before you place the scope on the firearm. Reconfirm that the chamber is empty if you stop the procedure then resume later. Safe firearms handling rules should be followed at all times.

The VarmintV² LRF comes with a Picatinny/Weaver mount. The type of mounting may vary depending on the region of sale. The mount is secured to the scope with two screws. The recommended tightening torque for the fixing screws is 4-5.3 Nm (5.44-7.2 ft lb)

To install the VarmintV² LRF with quick release mount to a Picatinny/Weaver rail, perform the following (Figure 2-5):

1. Unlock the clamping device of the scope mount by pushing down on the lever holder (A) and unlocking the lever (B).
2. Install the scope on the Picatinny/ Weaver rail so that the stop (C) slides into the transverse slot on the rail.
3. Affix the scope to the rail by locking the lever (B).
4. Verify that the clamping device is firmly holding the VarmintV² LRF. If necessary, adjust the clamping device's lever-cam lock as detailed in part 2.1.16 (Clamping Device Adjustment).

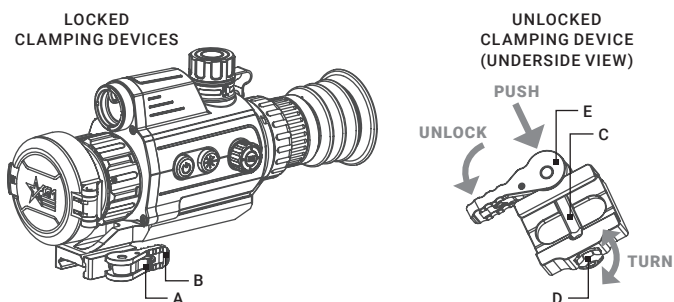

FIGURE 2-5. MOUNT

2.1.16 CLAMPING DEVICE ADJUSTMENT

To adjust the mount's clamping device, do the following:

1. Remove the VarmintV² LRF from the rail.
2. With the clamping device unlocked (as shown in Figure 2-5), push the cam (E) towards the arrow, which will cause the nut (D) to slide out of its hole.
3. To tighten/ loosen the clamping device, push down on the cam (E) and turn the nut (D) CW/ CCW respectively, in one-two increments (see note below). Much like when the cam (E) is released, backward-moving spring will cause the nut (D) to slide back into its hole.

NOTE:



The eight-sided nut of the mount lever-cam lock will only fit into their hole if turned in one of the discrete positions, using increments equal to 360°/8.

4. Verify that the adjusted lever-cam lock securely holds the mounting rail.

2.2 MAIN FUNCTIONS

2.2.1 MENU OPERATION

When the device is turned on, press and hold the MENU button  to display the menu.

Rotate the navigation wheel to move between menu items. The active element is highlighted. Press the MENU button  to select menu item or change an option. Hold the MENU button  to exit the menu.

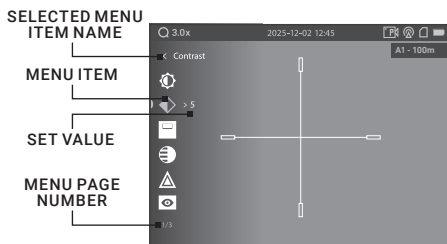



























FIGURE 2-6. ON-SCREEN DISPLAY

TABLE 2-3. MENU FUNCTIONS

MENU ITEM	SYMBOL	OPTION	FUNCTION
BRIGHTNESS		10 Levels of brightness	Adjusts the image brightness.
CONTRAST		10 Levels of contrast	Adjusts the image contrast.
PIP		OFF / ON	Enables or disables the PIP function.
TONE		Cold / Warm	Switch between the Cold and Warm image tone.
SHARPNESS		5 Levels of Sharpness	Adjusts the image sharpness.
SCENE MODE		Recognition / Jungle	Switch between the Recognition mode and Jungle mode.
ZEROING PROFILES		5 Profiles (A/B/C/D/E)	Zeroing profile selection with user saved zeroing settings.
ZEROING		Zeroing Menu:	
Zeroing		OFF / 1 / 2 / 3 / 4 / 5	Zeroing settings selection or disable reticle.
Distance		Distance	Setting the distance to the target.
Type		10 Reticle Type	Setting the reticle type.

MENU ITEM	SYMBOL	OPTION	FUNCTION
Color		4 Reticle Colors	Setting the reticle color (black, white, red, green)
Zoom		35-384: 3 - 24x 50-384: 4.5 - 36x 35-640: 2 - 16x 50-640: 2.5 - 20x (0.5x increment)	Setting the magnification with Digital Zoom.
Freeze Screen		OFF / ON	Image freeze.
Axis		X / Y	Setting the X-axis and Y-axis corrections.
BALLISTIC CALCULATION		Aim Point Style / Aim Point Color / Bullet / Initial Velocity / Zero Range / Altitude / Temperature / Ballistic Coefficient / Sight Height	Enables or disables the ballistic calculation. Setting up 5 profiles. Input the data to display the recommended aiming point and the drop distance.
RETICLE MODE		Fixed Reticle / Central Reticle	You can select a reticle mode according to your preference and different situations
LASER RANGING		Close / Once / Continuous (5s, 10s, 15s, 30s, 60s)	Enables or disables built-in laser rangefinder. Distance measurement mode settings.
NETWORK		Close / Hotspot	Enables or disables the Wi-Fi hotspot.
PRERECORD		OFF / 10S	Device can automatically record the 10 seconds before and after the recoil activation.
AUDIO		OFF / ON	Enable or disable audio recording.
HOT TRACKING		OFF / ON	Enables or disables hot spot mark (marking the spot of highest temperature).
FUNCTION SETTINGS		Function Settings Menu:	
OSD		OSD / Time / Date	Enables or disables the display of the OSD, time, date on the screen.
Brand Logo		OFF / ON	Enables or disables Brand Logo on the screen.

MENU ITEM	SYMBOL	OPTION	FUNCTION
Image Calib.		Auto / Semi-Auto / Manual	Selecting the Flat Field Correction (FFC) mode.
DPC		Axis: X / Y	Correction of dead pixel manually.
Burn Prevention		OFF / ON	Enables or disables the Burn Prevention function.
GENERAL SETTINGS		General Settings Menu:	
Language		26 Languages	Choice of interface language.
Time		12 / 24 hours	Time setting.
Date		Month/Day/Year	Date setting.
Unit		yd / m	Sets the distance unit.
Auto Power Off		OFF / 15 min / 30min / 45min	Setting the automatic shutdown time.
Reboot		---	Restoring the default basic settings: Brightness, Contrast, PIP, etc.
Restore Factory Settings		---	Restoring the default device settings, erase zeroing settings and all internal storage content.
Diagnostic Log		OFF / ON	Using for recording device status and troubleshooting.
Version		---	Firmware version and serial number.

2.2.2 BRIGHTNESS ADJUSTMENT





1. Hold the MENU button to show the main menu.
2. Rotate the wheel to select **Brightness** menu item and press the MENU button to adjust the brightness. You can select one of ten levels of the brightness to adjust the image lighter or darker.
3. Turn the wheel to move to another menu item or hold the MENU button to exit a menu.

2.2.3 CONTRAST ADJUSTMENT

1. Hold the MENU button to show the main menu.
2. Rotate the wheel to select **Contrast** menu item and press the MENU button to adjust the image contrast. You can select one of ten levels of the contrast.
3. Turn the wheel to move to another menu item or hold the MENU button to exit a menu.

2.2.3 PICTURE IN PICTURE MODE

The Picture-in-Picture (PIP) mode allows you to see simultaneously both a magnified image of the central part in a PIP window and the main image. The PIP window is displayed at the up-center of the live view.

1. Hold the MENU button  to show the main menu.
2. Select  PIP menu item and press the MENU button  to enable or disable Picture In Picture mode. The PIP window show in the upper part of screen.
3. Turn the wheel to move to another menu item or hold the MENU button  to exit a menu.





NOTES:

When Reticle is enabled, the PIP view is the detail of crosshair. When Reticle is not enabled, the PIP view is the detail of central part.

If digital zoom is enabled, the PIP view also zooms. If the digital zoom ratio exceeds 4, the PIP does not zoom.





2.2.4 IMAGE TONE SETTING

This function allows you to change the tone of thermal image to warm or cold.

1. Hold the MENU button  to show the main menu.
2. Rotate the wheel to select  Tone menu item and press the MENU button  to confirm.
3. Rotate the wheel to select **Warm** or **Cold** tone.
4. Hold the MENU button  to exit a menu.





2.2.5 SHARPNESS SETTING

This function allows you to adjust the sharpness of the thermal image.

1. Hold the MENU button  to show the main menu.
2. Rotate the wheel to select  Sharpness menu item and press the MENU button  to confirm.
3. Rotate the wheel to adjust the image sharpness.
4. Hold the MENU button  to exit a menu.





2.2.6 SCENE MODE

You can select proper Scene Mode according to environment temperature to improve the display effect.

1. Hold the MENU button  to show the main menu.
2. Rotate the wheel to select  Scene Mode menu item and press the MENU button  to confirm.
3. Rotate the wheel to switch scene mode:
Recognition mode: improves an image so that the object edge is more distinct.
Jungle mode: is more suitable for hunting environment because of the highlight function of small objects.
4. Hold the MENU button  to exit a menu.

2.2.7 ZEROING PROFILES

The user can customize and save five profiles with different reticle settings. In each profile, you can configure up to five types of reticle, firing distances and reticle corrections.

1. Hold the MENU button  to show the main menu.
2. Rotate the wheel to select  Zeroing Profiles menu item and press the MENU button  to confirm.
3. Rotate the wheel to switch the zeroing profile.
4. Hold the MENU button  to exit a menu.

The right top of the image displays the reticle information. For example, A1-50m means you are using the Zeroing No. 1 in the Profile A, and the set range is 50 m.







NOTE:

There are 5 zeroing profiles in total, and you can configure 5 reticles, zeroing distances and corrections in each zeroing profile.

2.2.8 ZEROING



You can select a reticle in the current zeroing profile, and set parameters such as reticle type, color, and boresight correction (coordinates) for the reticle.

Select a zeroing profile initially (refer to 2.2.7).

1. Hold the MENU button  to show the main menu.
2. Rotate the wheel to select  Zeroing menu item and press the MENU button  to enter the zeroing setting interface. Rotate the wheel to move between submenu and options.
3. Rotate the wheel to select  Zeroing No. You can select OFF to disable the reticle.
4. Set reticle type (for parameters of all built-in reticles, see part 5.2).
 - 1) In the zeroing setting interface rotate the wheel to select  Type submenu and press the MENU button  to confirm.
 - 2) Rotate the wheel to select a reticle type and press the MENU button  to confirm.

NOTE:

The scale intervals of Reticle 4 and 7 change synchronously under the current digital zoom.

5. Set reticle color.
 - 1) In the zeroing setting interface rotate the wheel to select  Color submenu and press the MENU button  to confirm.
 - 2) Rotate the wheel to select black, white, red or green color of reticle and press the MENU button  to confirm.

NOTE:

In Black Hot mode and White Hot mode, if you set the reticle color as white or black, the reticle colors can be automatically inverted depends on thermal image around the reticle.

6. (Optional) Repeat 3 to 5 to set type and color for other reticles in this profile.
7. Hold the MENU button  to exit a menu.

2.2.9 BORESIGHTING

Like any daytime rifle scope or red dot, sighting in is both similar, and simplified. The VarmintV² LRF comes with a one-shot zeroing system, which makes initial sighting in quick and painless.

Set the target to the selected zeroing distance. We recommend 50-100 yards initially. Select a zeroing profile (refer to 2.2.7). You can use different zeroing profiles if you want to use the optic on a different rifles.

Align the reticle with the center of the target and shoot. If the point of impact does not coincide with the aiming point, correct the reticle.

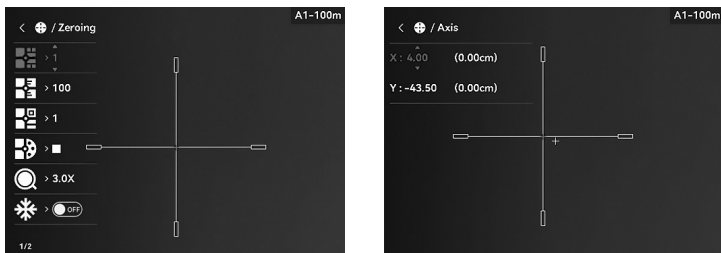













FIGURE 2-7. BORESIGHTING

1. Hold the MENU button  to show the main menu.
2. Rotate the wheel to select  Zeroing menu item and press the MENU button  to enter the zeroing setting interface.
3. Rotate the wheel to select  Zeroing number you want to correct and press the MENU button  to confirm.
4. Set the distance to the target:
 - 1) In the zeroing setting interface rotate the wheel to select  Distance and press the MENU button  to confirm.
 - 2) Press the MENU button to select the digit you want to change (color of selected digit will changed to the red) and press the MENU button  to confirm.
 - 3) Rotate the wheel to change the number and press the MENU button  to confirm.
5. (Optional) Rotate the wheel to select  Zoom option, and rotate the wheel to enlarge the image until the target positions is clear enough. Press the MENU button  to confirm.

NOTE:

We'd suggest zeroing in at 1x digital zoom, or your true optical base magnification, or 2x zoom (double your optical magnification) as these options are less pixelated and should provide for easier adjustments.

6. (Optional) Rotate the wheel to select  Freeze Screen option, and press the MENU button to enable the Freeze Screen function.

NOTE:

When enabling the Freeze Screen function, you can adjust the position of the cursor on a frozen image. This feature helps prevent image flutter and eliminates the need to hold the rifle scope steady in order to make your windage and elevation adjustments on screen.

7. Select **+** Axis and press the MENU button **⊞** to confirm.

Two crosshairs are displayed on the screen. The big one is reticle crosshair, and the small one is reference crosshair. Reference crosshair will appear in the centre of the display. Initially, the centers of both crosshairs are aligned. Zero the scope by moving the reticle on the screen:

- 1) Aim the reticle at the center of target.
- 2) Press the MENU button **⊞** to select X or Y axis.
- 3) Rotate the wheel to move reticle left and right (if X axis is selected) or to move reticle up and down (if Y axis is selected).

Holding the reference small crosshair at the aiming point (center of the target) and move the reticle until it is aligned with the point of impact. The coordinates show the current position of the reticle. It also displays the distance by which the point of impact will move, taking into account the set distance to the target.

8. (Optional) Repeat 3 to 7 to set the position for other reticles in this profile. You can place up to five zeroes at different distances within the same profile (useful for certain calibers with highly fluctuating trajectories between 50 and 250 yards).

9. Hold the MENU button **⊞** to exit a menu. The window "Save the parameters?" will appear.

- OK: Save the settings and exit.
- CANCEL: Exit without saving the settings.

TABLE 2-4. BORESIGHT CORRECTION (ONE PIXEL SHIFT FOR ONE CLICK)

MODEL	ADJUSTMENT VALUE	RETICLE OFFSET	BORESIGHT INCREMENT
VARMINT V ² LRF 35-384	1 click	1 pixel	0.13 mil / 0.44 MOA / 1.3 cm at 100 m distance / 0.46 in at 100 yd distance
VARMINT V ² LRF 50-384	1 click	1 pixel	0.09 mil / 0.31 MOA / 0.9 cm at 100 m distance / 0.32 in at 100 yd distance
VARMINT V ² LRF 35-640	1 click	1 pixel	0.22 mil / 0.73 MOA / 2.2 cm at 100 m distance / 0.76 in at 100 yd distance
VARMINT V ² LRF 50-640	1 click	1 pixel	0.15 mil / 0.51 MOA / 1.5 cm at 100 m distance / 0.53 in at 100 yd distance





2.2.10 BALLISTIC CALCULATION

The ballistic calculation helps you have a better experience in various conditions. Multiple parameters are required in calculation to ensure precision and flexibility of use.

NOTE:

Make sure the reticle is enabled and you have finished zeroing.

1. Hold the MENU button **⊞** to show the main menu.

2. Rotate the wheel to select  **Ballistic Calculation**. Press the MENU button  to enter the setting interface.
3. Select **Ballistic Profile** and press the MENU button  to on/off this function.
4. Rotate the wheel to select **Ballistic Profile** and press the MENU button  to switch the profile (1 to 5). You can configure and save different settings for each of the 5 profiles.
5. Rotate the wheel to select the following parameters, and press the MENU button to input the data.
 - Aim Point Style:** Set the style of the aim point (•, ×, >•<, Δ).
 - Aim Point Color:** Set the color of the aim point (black, white, red, green).
 - Bullet:** Set the bullet-specific drag model, e.g. G1, G7 and GS.
 - Initial Velocity:** Input the muzzle velocity of your projectile.

NOTE:

Velocity varies depending on different conditions, barrel length, etc. Muzzle velocity can be obtained by using an accurate ballistic chronograph and/or by following ammo manufacturer specifications.



Zero Range: Set the distance you have zeroed the device at.

Altitude: Set current local altitude.

Temperature: Set the ambient temperature.

Ballistic Coefficient (B.C.): The measure of its ability to overcome air resistance.

Sight Height: The distance between the bore and the center of the lens.





6. Press the MENU button  to switch digit, and rotate the wheel to change the number.
7. Hold the MENU button  to save and exit.
8. Aim the LRF mark at the target and press LRF button  to measure the distance. The screen will display the recommended aiming point × and the drop distance in the upper right corner of the interface.
9. (Optional) To adjust distance, repeat the step 8.

NOTE:

- 5 ballistic profiles can be saved.
- The more parameters you specify, the more accurate the recommended aiming point will be.
- The drop distance is related to the input parameters. Please refer to the actual situation.

2.2.12 RETICLE MODE

You can select a reticle mode according to your preference and different situations.

1. Hold the MENU button  to show the main menu.
2. Rotate the wheel to select  **Reticle Mode** and press the MENU button  to confirm.
3. Rotate the wheel to select a reticle mode and press the MENU button  to confirm.

Central Reticle: This mode centers around the image when switching the digital zoom ratio, with the reticle position unchanged.





Fixed Reticle: This mode centers around the reticle when switching the digital zoom ratio.

NOTE:

- The digital zoom ratio returns to 1× when switching the reticle mode.
- If you select fixed reticle, the zoom ratio can be set from 1.0× to 8.0×.
- If you select central reticle, the zoom ratio can be set from 2.0× to 8.0×.



2.2.13 SET LASER RANGING

The device can detect the distance between the target and the observation position with built-in laser rangefinder.

1. Hold the MENU button  to show the main menu.
2. Rotate the wheel to select  **Laser Ranging** menu item and press the MENU button  to switch the laser ranging mode.
3. Rotate the wheel to select the laser ranging mode between **Close** (rangefinder disabled), **Once** and **Continuous (5s)**, **Continuous (10s)**, **Continuous (15s)**, **Continuous (30s)**, **Continuous (60s)**. Press the MENU button  to set selected mode.

NOTE:





Continuous ranging is not available when enabling the ballistic calculation.

4. Hold the MENU button  to return to the live view interface.
5. When the Once mode is selected, point the square mark of the rangefinder at the target and press the LRF button  to measure the distance to the target.
6. You can scan the surroundings under Continuous mode. Continuous distance scanning will occur for a set time of 5, 10, 15, 30 or 60 seconds after pressing the LRF button .

The distance measurement result is displayed at the upper right of the image.

2.2.14 NETWORK CONFIGURATION

Connect your phone to the Wi-Fi hotspot of the rifle scope, you can configure the parameters and realize functions of the device.

1. Hold the MENU button  to show the main menu.
2. Select  **Network** menu item and press the MENU button  to enable or disable Wi-Fi hotspot.
3. Hold the MENU button  to exit a menu.





Open the AGM Connect APP and connect your phone with the device (refer to Section 2.3). You can view the interface of rifle scope on your phone.

NOTE:

When the power is less than 15%, the Wi-Fi hotspot function will be turned off automatically.

2.2.15 PRERECORD VIDEO

After enabling the Shot Activated Recording (SAR) function, the device will automatically start recording 10 seconds before the recoil-activation and end recording 7 seconds after the recoil-activation.





1. Hold the MENU button  to show the main menu.
2. Rotate the wheel to select  **Prerecord** menu item.
3. Press the MENU button  to set the SAR function **OFF** or **10S**.
4. Hold the MENU button  to exit a menu.

NOTE:

For exporting recorded files, refer to **Export Files (part 2.1.14)**.





2.2.16 AUDIO RECORDING SETTING

The Audio function allows you to record sound along with video. If there is too much noise when recording, this function can be disabled.

1. Hold the MENU button  to show the main menu.
2. Rotate the wheel to select  **Audio** menu item, and press the MENU button  to enable or disable this function.
3. Hold the MENU button  to exit a menu.

2.2.17 HOT TRACKING







The device can detect the highest temperature spot in the scene and mark it on display.

1. Hold the MENU button  to show the main menu.
2. Rotate the wheel to select  **Hot Tracking** menu item and press the MENU button  to enable/disable hot spot mark (marking the spot of highest temperature).
3. Hold the MENU button  to exit a menu.

When the hot spot mark is enabled, the green cross mark  displays in the spot of the highest temperature. When the scene changes, the green mark moves.







2.2.18 ON-SCREEN DISPLAY (OSD)

You can choose which OSD information to display in the live view user interface. Options include, wi-fi hotspot activation, current magnification, memory storage status, battery indicator status, time and date. These will appear at the top of the display interface when activated.

1. Hold the MENU button  to show the main menu.
2. Rotate the wheel to select  **Function Settings** menu and press the MENU button  to confirm.
3. Rotate the wheel to select  **OSD** OSD submenu and press the MENU button  to enter.
4. Rotate the wheel to select the **OSD**, **Time** or **Date**. Press the MENU button  to display or hide the necessary information.
5. Hold the MENU button  to exit a menu.

2.2.19 BRAND LOGO

You can display the AGM logo in the lower left corner of the screen.



1. Hold the MENU button  to show the main menu.
2. Rotate the wheel to select  **Function Settings** menu and press the MENU button  to confirm
3. Rotate the wheel to select  **Brand Logo** submenu and press the MENU button  to enable or disable the logo.
4. Hold the MENU button  to exit a menu.



2.2.20 IMAGE CALIBRATION

The image calibration function performs what is known as the Flat Field Correction or FFC. This is required of all thermal devices. This can correct for non-uniformity of the display. During correction an internal shutter will be lowered in front of the thermal detector. A “click” sound will often be heard, and the image is momentarily interrupted for a split second. After this quick process the detector will be re-calibrated, and the image becomes more accurate. AGM recommends automatic when scanning for game or targets. However, we recommend going into the menu and changing to Manual correction mode when getting close making your shot. This will prevent any unwanted auto-correction occurring when tracking live game. This will help shooters in making ethical shot placements at all times.

1. Hold the MENU button  to show the main menu.
2. Rotate the wheel to select  **Function Settings** menu and press the MENU button  to confirm
3. Rotate the wheel to select  **Image Calib.** submenu and press the MENU button  to enter.
4. Rotate the wheel to switch the FFC mode.

Auto: The rifle scope performs FFC automatically when switching on or rebooting the camera.

Semi-Auto: In live view mode press the POWER button  and LRF button  at the same time to release the shutter once for correction of the non-uniformity of display.



Manual: Cover the lens cap, then press the POWER button  and LRF button  at the same time to correct the non-uniformity of display.





5. Hold the MENU button  to exit a menu.

2.2.21 DEFECTIVE PIXELS CORRECTION

The Defective Pixel Correction (DPC) can help users repair the occasional de-activated pixel within the display. This is fairly common in thermal optics, which is why so many of these optics come equipped with a DPC feature. 1-3 dead pixels are usually easily repaired by the user. Anything over 3 that cannot be repaired, will open the unit up to an approved warranty repair by AGM at their facility.







Before you start switch the palette to White Hot mode.

1. Hold the MENU button  to show the main menu.
2. Rotate the wheel to select  **Function Settings** menu and press the MENU button  to confirm.

3. Rotate the wheel to select  DPC submenu and press the MENU button  to enter.
4. Rotate the wheel to select the X or Y axis and press the MENU button  to confirm.
5. Rotate the wheel to set the coordinates until the cursor reaches the dead pixel.
6. Press the MENU button  to correct the dead pixel.
7. (Optional) Repeat 4 to 6 to correct the position for other dead pixels.
8. Hold the MENU button  to exit a menu.







2.2.22 BURN PREVENTION

This function can prevent damage to the thermal sensor from the sun or other high temperature bright light sources. When enabling this function, the shield will close until the environment turns to normal. This feature may be useful to help protect sensitive displays during extreme summer temperatures. AGM recommends all units be stored in room temperature whenever possible, as long periods of storage in extreme heat (such as inside a vehicle) may lead to issues with the display materials.









1. Hold the MENU button  to show the main menu.
2. Rotate the wheel to select  Function Settings menu and press the MENU button  to confirm.
3. Rotate the wheel to select  Burn Prevention submenu and press the MENU button  to enable or disable the Burn Prevention function.
4. Hold the MENU button  to exit a menu.

2.2.23 LANGUAGE SETTING









You can select different languages of user interface.

1. Hold the MENU button  to show the main menu.
2. Rotate the wheel to select  General Settings and press the MENU button  to confirm.
3. Rotate the wheel to select  Language submenu and press the MENU button  to enter.
4. Rotate the wheel to select the language as required and press the MENU button  to confirm.
5. Hold the MENU button  to exit a menu.

2.2.24 TIME SETTING







1. Hold the MENU button  to show the main menu.
2. Rotate the wheel to select  General Settings and press the MENU button  to confirm.
3. Rotate the wheel to select  Time submenu and press the MENU button  to enter the configuration interface.
4. Press the MENU button  to select the hour, minute, second to be synchronized and press the MENU button  to change the number, then press the MENU button  again to finish the setting.
5. Hold the MENU button  to exit a menu.

2.2.25 DATE SETTING

1. Hold the MENU button  to show the main menu.
2. Rotate the wheel to select  **General Settings** and press the MENU button  to confirm.
3. Rotate the wheel to select  **Date** submenu and press the MENU button  to enter the configuration interface.
4. Press the MENU button  to select the month, day or year to be synchronized and press the MENU button  to change the number, then press the MENU button  again to finish the setting.
5. Hold the MENU button  to exit a menu.







2.2.26 UNIT SETTING

You can set the unit (yards or meters) of measurement for distance.

1. Hold the MENU button  to show the main menu.
2. Rotate the wheel to select  **General Settings** and press the MENU button  to confirm.
3. Rotate the wheel to select  **Unit** submenu and press the MENU button  to enter the configuration interface.
4. Press the MENU button  to select **yd** (yards) or **m** (meters).
5. Hold the MENU button  to exit a menu.





2.2.27 AUTO POWER OFF

You can set the time for the automatic shutdown of the device as required.

1. Hold the MENU button  to show the main menu.
2. Rotate the wheel to select  **General Settings** and press the MENU button  to confirm.
3. Rotate the wheel to select  **Auto Power Off** submenu and press the MENU button  to enter the configuration interface.
4. Rotate the wheel to select OFF, 15 min, 30 min or 45 min and press the MENU button  to confirm.
5. Hold the MENU button  to exit a menu.

2.2.28 REBOOT





You can reset the default basic settings: Brightness, Contrast, PIP, etc.

1. Hold the MENU button  to show the main menu.
2. Rotate the wheel to select  **General Settings** and press the MENU button  to confirm.
3. Rotate the wheel to select  **Reboot** and press the MENU button . The window **"Reset the basic settings"** will appear.
 - **OK**: Restore the basic settings to defaults.
 - **CANCEL**: Exit without changing the settings.

2.2.29 RESTORE FACTORY SETTINGS







You can erase all content in the built-in storage and reset all basic settings and zeroing settings.

1. Hold the MENU button  to show the main menu.

2. Rotate the wheel to select  **General Settings** and press the MENU button  to confirm.
3. Rotate the wheel to select  **Restore Factory Settings** and press the MENU button . The window “Erase all content and settings” will appear.
 - **OK**: Erase all content and restore all settings to defaults.
 - **CANCEL**: Exit without changing the settings.





2.2.30 DIAGNOSTIC LOG

Diagnostic Log using for recording device status and troubleshooting. You can find the log files in the *log* folder in the device memory and send them to the support service if necessary (see paragraph 2.1.14 about exporting files).

1. Hold the MENU button  to show the main menu.
2. Rotate the wheel to select  **General Settings** and press the MENU button  to confirm.
3. Rotate the wheel to select  **Diagnostic Log** and press the MENU button . A confirmation window will appear.
4. Select **OK** and press the MENU button  to start recording the log.

2.2.31 VERSION

You can view the device information such as firmware version and serial number.

1. Hold the MENU button  to show the main menu.
2. Rotate the wheel to select  **General Settings** and press the MENU button  to confirm.
3. Rotate the wheel to select  **Version** item and press the MENU button  to confirm. The firmware version and serial number will be displayed.

2.3 CLIENT SOFTWARE INTRODUCTION

Search the AGM Connect software in App Store (iOS System) or Google Play™ (Android System) and install the application on your mobile phone. Turn on the Wi-Fi hotspot on the thermal device and then connect your phone to the hotspot.

- Hotspot Name: Wlan-<Serial No.>

- Hotspot Password: Last 9 digits of Serial Number of your digital scope.

NOTE:

The device password is set by user at first activation. If the password was lost or forgotten, it can be reset. To reset a password perform the following steps:

1. When the rifle scope is turned on, hold the MENU button (⋮) to activate the OSD menu.

2. Select (↺) Restore item and press the MENU button (⋮) to restore all parameters to default settings.

1. Run the app and connect the phone or tablet with the device.

2. If the device is inactivated, set the password and activate it. If the device is activated, enter the password to add it to the app.

3. When the device is added, the live view can be seen. You can view the interface of the device on the software. User can change such image parameters as brightness, contrast, zoom, palettes directly via phone or tablet as well as record video on phone/tablet memory. You can also quickly zero your scope using the AGM Connect app.

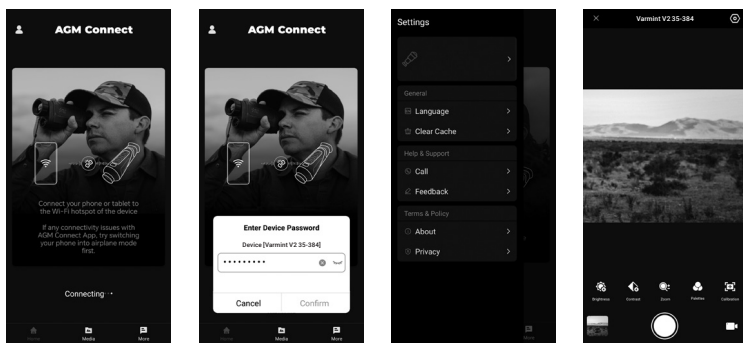

FIGURE 2-8. AGM CONNECT APP

3 MAINTENANCE

3.1 MAINTENANCE

3.1.1 CLEANING PROCEDURES

1. Gently brush off any dirt from the body of the device using a clean, soft cloth.
2. Moisten the cloth with fresh water and gently wipe down the external surfaces (except lenses).
3. Dry any wet surfaces (except lenses) using another dry, clean, soft cloth.
4. Using a lens brush, carefully remove all loose dirt from the lenses.
5. Dampen a cotton swab with ethanol and slowly, gently wipe down the lenses. Clean the glass surfaces using circular movements, starting from the center of the lens and moving out towards the edge, without touching the lens holder. Change the cotton swab after each circular stroke. Repeat this step until the glass surfaces are clean.
6. Clean the accessories with a soft brush (or cloth) dampened with soap and water.

3.1.2 LASER MAINTENANCE

It is not necessary to maintain the laser regularly. If the laser does not work, the laser assembly needs to be replaced in the factory under warranty.

CAUTION:

Use of controls or adjustments or performance of procedures other than those specified herein may result in hazardous radiation exposure.

3.1.3 PREPARING FOR EXTENDED STORAGE

CAUTION:

Thoroughly dry each item before placing them into the storage case.

To prepare the rifle scope for extended storage:

1. Clean the rifle scope and accessories.
2. Place all items into the storage case.

3.1.4 UPDATING THE DEVICE FIRMWARE

1. Visit www.agmglobalvision.com/firmware website. Select your product, download the firmware update package to your PC and unzip it. Follow the detailed instructions on the website.
2. Connect the device to your PC with USB cable.
3. Turn on the device. Make sure the Wi-Fi hotspot function is disabled.
4. Open the detected disk (USB drive) in file manager program. Copy the unzipped **digicap.dav** file and paste it to the root directory of the device.

5. Turn off the device completely, then power it back on. After awhile, the firmware update process will start automatically. During the update, the screen will display the inscription “Upgrading...”. The update process will be completed when the inscription “Upgrading...” goes out.

6. Turn off the device and disconnect it from your PC.

You can also enjoy automatic update function in AGM Connect App (see part 2.3 for details).

1. Start the AGM Connect App and tap the Settings icon in the left top corner.

2. Tap your device in the device list. The information about device will shown.

3. Tap **Checking for Upgrade** to detect and download the latest FW version.

3.2 TROUBLESHOOTING

Table 3-1 lists the most common malfunctions that may occur with your equipment. Perform the tests, inspections, and corrective actions in the order they appear in the table.

This table does not list all the malfunctions that may occur with your device, or all of the tests, inspections, and corrective actions that may be necessary to fix them. If the equipment malfunction is not corrected by the suggested actions, or a problem occurs that is not listed in this table, please contact AGM Global Vision’s Customer Support center or your retailer.

TABLE 3-1. TROUBLESHOOTING

MALFUNCTION	CORRECTIVE ACTION
The rifle scope fails to activate.	<ol style="list-style-type: none"> 1. Battery is missing or improperly installed. Insert battery or install correctly. 2. Battery is dead. Replace the battery. 3. Battery, surfaces or contacts are dirty or corroded. Clean the contact.
Device power indicator is off.	Examine whether the device is off-battery.
The image of the rifle scope is not clear.	Perform the rifle scope adjustment referring to part 2.1.
Capturing or recording fails.	Examine the items below: <ol style="list-style-type: none"> 1. Whether the device is connected to your PC and disabled the capturing and recording. 2. Whether the storage space is full. 3. Whether the device is low-battery.
The PC cannot identify the rifle scope.	Examine the items below: <ol style="list-style-type: none"> 1. Whether the device is connected to your PC with standard USB cable. 2. If you use other USB cables, make sure the cable length is no longer than 1 m.

4 WARRANTY INFORMATION

4.1 WARRANTY INFORMATION AND REGISTRATION

The below description of AGM Global Vision warranty terms and conditions refer specifically to AGM branded products purchased within the United States. Customers purchasing AGM products outside the United States can obtain specific information about their product's warranty term on the www.agmglobalvision.eu website.

4.1.1 WARRANTY INFORMATION

This product is guaranteed to be free from manufacturing defects in material and workmanship under normal use for a period of **five (5) years** from the date of purchase. In the event that a defect covered by the warranty below occurs during the applicable period stated above, AGM Global Vision, at its discretion, will either repair or replace the product; such action on the part of AGM Global Vision shall be the full extent of AGM Global Vision's liability, and the Customer's sole and exclusive reparation. This warranty does not cover a product if it has been (a) used in ways other than its normal and customary manner; (b) subjected to misuse; (c) subjected to alterations, modifications or repairs by the Customer or by any party other than AGM Global Vision without prior written consent of AGM Global Vision; (d) is the result of a special order or categorized as "close-out" merchandise or merchandise sold "as-is" by either AGM Global Vision or the AGM Global Vision dealer; or (e) merchandise that has been discontinued by the manufacturer and either parts or replacement units are not available due to reasons beyond the control of AGM Global Vision. AGM Global Vision shall not be responsible for any defects or damage that in AGM Global Vision's view are a result from the mishandling, abuse, misuse, improper storage or improper operation of the device, including use in conjunction with equipment that is electrically or mechanically incompatible with, or of inferior quality to, the product, as well as failure to maintain the environmental conditions specified by the manufacturer. This warranty is extended only to the original purchaser. Any breach of this warranty shall be enforced unless the customer notifies AGM Global Vision at the address noted below within the applicable warranty period.

The customer understands and agrees that except for the foregoing warranty, no other warranties written or oral, statutory, expressed or implied, including any implied warranty of merchantability or fitness for a particular purpose, shall apply to the product. All such implied warranties are hereby and expressly disclaimed.

4.1.2 LIMITATION OF LIABILITY

AGM Global Vision will not be liable for any claims, actions, suits, proceedings, costs, expenses, damages, or liabilities arising out of the use of this product. Operation and use of the product are the sole responsibility of the Customer. AGM Global Vision's sole undertaking is limited to providing the products and services outlined herein in accordance with the terms and conditions of

this Agreement. The provision of products sold and services performed by AGM Global Vision to the Customer shall not be interpreted, construed, or regarded, either expressly or implied, as being for the benefit of or creating any obligation toward any third party of legal entity outside AGM Global Vision and the Customer; AGM Global Vision's obligations under this Agreement extend solely to the Customer. AGM Global Vision's liability hereunder for damages, regardless of the form or action, shall not exceed the fees or other charges paid to AGM Global Vision by the customer or customer's dealer. AGM Global Vision shall not, in any event, be liable for special, indirect, incidental, or consequential damages, including, but not limited to, lost income, lost revenue, or lost profit, whether such damages were foreseeable or not at the time of purchase, and whether or not such damages arise out of a breach of warranty, a breach of agreement, negligence, strict liability, or any other theory of liability.

4.1.3 PRODUCT REGISTRATION

In order to validate the warranty on your product, the customer must complete and submit AGM Global Vision PRODUCT REGISTRATION FORM on our website (www.agmglobalvision.com/customer-support).

4.1.4 OBTAINING WARRANTY SERVICE

To obtain warranty service on your unit, the End-user (Customer) must notify the AGM Global Vision service department via e-mail. Send any requests to support@agmglobalvision.com to receive a Return Merchandise Authorization number (RMA). When returning any device, please take the product to your retailer, or send the product, postage paid and with a copy of your sales receipt, to AGM Global Vision's service center at the address listed above. All merchandise must be fully insured with the correct postage; AGM Global Vision will not be responsible for improper postage or merchandise that becomes lost or damaged during shipment. When sending product back, please clearly write the RMA# on the outside of the shipping box. Please include a letter that indicates your RMA#, the Customer's Name, a Return Address, reason for the return, contact information (valid telephone numbers and/or an e-mail address), and proof of purchase that will help us to establish the valid start date of the warranty. Product merchandise returns that do not have an RMA# listed may be refused, or a significant delay in processing may occur. Estimated Warranty service time is 10-20 business days. The End-user/Customer is responsible for postage to AGM Global Vision for warranty service. AGM Global Vision will cover return postage/shipping after warranty repair to the End-user/Customer only if the product is covered by the aforementioned warranty. AGM Global Vision will return the product after warranty service by domestic UPS Ground service and/or domestic mail. Should any other requested, required, or international shipping methods be necessary, the postage/shipping fee will be the responsibility of the End-user/Customer.

For service, repair or replacement, please contact:

AGM Global Vision, LLC

2407 E Interstate 30, Suite 100

Grand Prairie, TX 75050

Tel. 928.333.4300

support@agmglobalvision.com

www.agmglobalvision.com

5 SPECIFICATIONS

5.1 SPECIFICATIONS

	VARMINT V ² LRF 35-384	VARMINT V ² LRF 50-384	VARMINT V ² LRF 35-640	VARMINT V ² LRF 50-640
Detector Type	12 μm VOx Uncooled Focal Plane Array	12 μm VOx Uncooled Focal Plane Array	12 μm VOx Uncooled Focal Plane Array	12 μm VOx Uncooled Focal Plane Array
Resolution	384×288	384×288	640×512	640×512
NETD	Less than 20 mK (25°C, F# = 1.0)	Less than 20 mK (25°C, F# = 1.0)	Less than 20 mK (25°C, F# = 1.0)	Less than 20 mK (25°C, F# = 1.0)
Refresh Rate	50 Hz	50 Hz	50 Hz	50 Hz
Lens System	35 mm; F1.0	50 mm; F1.0	35 mm; F1.0	50 mm; F1.0
Field of View (HxV)	7.53° × 5.65°	5.28° × 3.96°	12.52° × 10.03°	8.78° × 7.03°
Magnification	3x – 24x	4.5x – 36x	2x – 16x	2.5x – 20x
Digital Zoom	0.5x increment	0.5x increment	0.5x increment	0.5x increment
Observation Distance	1,800 m	2,600 m	1,800 m	2,600 m
Eye Relief	45 mm	45 mm	45 mm	45 mm
Monitor	1024×768, 0.39 inch, OLED, 50 Hz	1024×768, 0.39 inch, OLED, 50 Hz	1024×768, 0.39 inch, OLED, 50 Hz	1024×768, 0.39 inch, OLED, 50 Hz
FFC (Flat Field Correction)	Auto, Semi-Auto, Manual	Auto, Semi-Auto, Manual	Auto, Semi-Auto, Manual	Auto, Semi-Auto, Manual
Palettes	Black Hot, White Hot, Red Hot, Fusion	Black Hot, White Hot, Red Hot, Fusion	Black Hot, White Hot, Red Hot, Fusion	Black Hot, White Hot, Red Hot, Fusion
Highest Temperature Spot Tracking	Yes	Yes	Yes	Yes
Scene Mode	Jungle, Recognition	Jungle, Recognition	Jungle, Recognition	Jungle, Recognition
Reticle	10 types, 4 colors, on/off	10 types, 4 colors, on/off	10 types, 4 colors, on/off	10 types, 4 colors, on/off
Laser Range Finder	Up to 600 m ±1 m accuracy	Up to 600 m ±1 m accuracy	Up to 600 m ±1 m accuracy	Up to 600 m ±1 m accuracy
Laser Wavelength	905 nm	905 nm	905 nm	905 nm

	VARMINT V ² LRF 35-384	VARMINT V ² LRF 50-384	VARMINT V ² LRF 35-640	VARMINT V ² LRF 50-640
Laser Safety Class	Class 1	Class 1	Class 1	Class 1
Minimum Measuring Range	10 m	10 m	10 m	10 m
Boresight Adjustment	Digital Controlled	Digital Controlled	Digital Controlled	Digital Controlled
Boresight Increment	0.13 mil / 0.44 MOA	0.09 mil / 0.31 MOA	0.22 mil / 0.73 MOA	0.15 mil / 0.51 MOA
Hotspot	Yes	Yes	Yes	Yes
Sleep Mode	Yes	Yes	Yes	Yes
Picture-in-Picture Mode	Yes	Yes	Yes	Yes
Burn Prevention	Yes	Yes	Yes	Yes
Built-in Storage	16 GB EMMC	16 GB EMMC	16 GB EMMC	16 GB EMMC
Record Video	Yes	Yes	Yes	Yes
Image Capture	Yes	Yes	Yes	Yes
Battery Type	One 18650 (3.6V) Lithium Rechargeable Battery	One 18650 (3.6V) Lithium Rechargeable Batteries	One 18650 (3.6V) Lithium Rechargeable Batteries	One 18650 (3.6V) Lithium Rechargeable Batteries
Battery Life (WiFi and LRF off)	6 hours	6 hours	5 hours	5 hours
Battery Capacity Display	Yes	Yes	Yes	Yes
External Power	5 VDC/2 A, USB Type-C	5 VDC/2 A, USB Type-C	5 VDC/2 A, USB Type-C	5 VDC/2 A, USB Type-C
Working Temperature	-30°C to 55°C (-22°F to 131°F)	-30°C to 55°C (-22°F to 131°F)	-30°C to 55°C (-22°F to 131°F)	-30°C to 55°C (-22°F to 131°F)
Protection Level	IP67	IP67	IP67	IP67
Max. Recoil	1000 g / 0.4 ms	1000 g / 0.4 ms	1000 g / 0.4 ms	1000 g / 0.4 ms
Dimensions (w/o mount)	214×67×87 mm (8.4×2.6×3.4 in)	227×74×87 mm (8.9×2.9×3.4 in)	214×67×87 mm (8.4×2.6×3.4 in)	227×74×87 mm (8.9×2.9×3.4 in)
Weight (w/o batteries)	518 g (1.14 lb)	585 g (1.29 lb)	518 g (1.14 lb)	585 g (1.29 lb)

**All data subject to change without notice.*

5.2 RETICLE PARAMETERS

IMAGE	ITEM	MOA	CM @ 100 M	IN @ 100 YD	ITEM	MOA	CM @ 100 M	IN @ 100 YD	
	VarmintV² LRF 35-384				VarmintV² LRF 50-384				
	A	94.0	273.4	98.4	A	65.9	191.7	69.0	
	B	19.0	55.3	19.9	B	13.3	38.7	13.9	
	C	5.7	16.6	6.0	C	4.0	11.6	4.2	
	D	6.2	18.0	6.5	D	4.3	12.5	4.5	
	VarmintV² LRF 35-640				VarmintV² LRF 50-640				
	A	166.9	485.5	174.7	A	117.0	340.4	122.5	
	B	31.5	91.6	33.0	B	22.1	64.3	23.1	
	C	10.2	29.7	10.7	C	7.1	20.7	7.4	
	D	11.0	32.0	11.5	D	7.7	22.4	8.1	
		VarmintV² LRF 35-384				VarmintV² LRF 50-384			
		A	112.5	327.3	117.8	A	78.8	229.2	82.5
		B	105.0	305.4	109.9	B	73.6	214.1	77.1
		C	6.2	18.0	6.5	C	4.3	12.5	4.5
VarmintV² LRF 35-640				VarmintV² LRF 50-640					
A		199.8	581.2	209.2	A	140.1	407.6	146.7	
B		186.5	542.5	195.3	B	130.7	380.2	136.8	
C		11.0	32.0	11.5	C	7.7	22.4	8.1	
		VarmintV² LRF 35-384				VarmintV² LRF 50-384			
		A	112.5	327.3	117.8	A	78.8	229.2	82.5
	B	105.0	305.4	109.9	B	73.6	214.1	77.1	
	C	6.2	18.0	6.5	C	4.3	12.5	4.5	
	VarmintV² LRF 35-640				VarmintV² LRF 50-640				
	A	199.8	581.2	209.2	A	140.1	407.6	146.7	
	B	186.5	542.5	195.3	B	130.7	380.2	136.8	
	C	11.0	32.0	11.5	C	7.7	22.4	8.1	

IMAGE	ITEM	MOA	CM @ 100 M	IN @ 100 YD	ITEM	MOA	CM @ 100 M	IN @ 100 YD
	VarmintV² LRF 35-384				VarmintV² LRF 50-384			
	A	87.8	255.4	91.9	A	61.5	178.9	64.4
	B	79.9	232.4	83.7	B	56.0	162.9	58.6
	C	21.2	61.7	22.2	C	14.8	43.1	15.5
	D	4.0	11.6	4.2	D	2.8	8.1	2.9
	E	26.0	75.6	27.2	E	18.2	52.9	19.1
	F	2.2	6.4	2.3	F	1.5	4.4	1.6
	G	6.6	19.2	6.9	G	6.8	19.8	7.1
	H	6.6	19.2	6.9	H	6.2	18.0	6.5
	I	6.2	18.0	6.5	I	4.3	12.5	4.5
	J	5.3	15.4	5.5	J	3.7	10.8	3.9
	K	3.5	10.2	3.7	K	2.5	7.3	2.6
	VarmintV² LRF 35-640				VarmintV² LRF 50-640			
	A	156.0	453.8	163.3	A	109.3	318.0	114.4
	B	132.8	386.3	139.0	B	93.1	270.8	97.5
	C	37.6	109.4	39.4	C	26.3	76.5	27.5
	D	6.6	19.2	6.9	D	4.6	13.4	4.8
	E	43.4	126.3	45.4	E	30.4	88.4	31.8
	F	3.9	11.3	4.1	F	2.7	7.9	2.8
	G	7.0	20.4	7.3	G	6.2	18.0	6.5
	H	7.0	20.4	7.3	H	7.1	20.7	7.4
I	11.0	32.0	11.5	I	7.7	22.4	8.1	
J	9.4	27.3	9.8	J	6.6	19.2	6.9	
K	6.3	18.3	6.6	K	4.4	12.8	4.6	
	VarmintV² LRF 35-384				VarmintV² LRF 50-384			
	A	3.1	9.0	3.2	A	2.2	6.4	2.3
	B	3.5	10.2	3.7	B	2.5	7.3	2.6
	C	0.9	2.6	0.9	C	0.9	2.6	0.9
	D	1.3	3.8	1.4	D	0.6	1.7	0.6
	VarmintV² LRF 35-640				VarmintV² LRF 50-640			
	A	5.0	14.6	5.2	A	3.9	11.3	4.1
	B	5.7	16.7	6.0	B	4.4	12.8	4.6
	C	5.0	14.6	5.2	C	1.6	4.7	1.7
	D	1.4	4.2	1.5	D	1.0	2.9	1.0
	VarmintV² LRF 35-384				VarmintV² LRF 50-384			
	A	5.3	15.4	5.5	A	3.7	10.8	3.9
	B	1.3	3.8	1.4	B	0.9	2.6	0.9
	VarmintV² LRF 35-640				VarmintV² LRF 50-640			
	A	8.8	25.6	9.2	B	6.2	18.0	6.5
B	2.2	6.4	2.3	C	1.5	4.4	1.6	

IMAGE	ITEM	MOA	CM @ 100 M	IN @ 100 YD	ITEM	MOA	CM @ 100 M	IN @ 100 YD
	VarmintV² LRF 35-384				VarmintV² LRF 50-384			
	A	113.0	328.7	118.3	A	79.2	230.4	82.9
	B	91.3	265.6	95.6	B	64.0	186.2	67.0
	C	21.6	62.8	22.6	C	15.2	44.2	15.9
	D	3.1	9.0	3.2	D	2.2	6.4	2.3
	E	6.2	18.0	6.5	E	4.3	12.5	4.5
	F	3.5	10.2	3.7	F	2.5	7.3	2.6
	G	5.3	15.4	5.5	G	3.7	10.8	3.9
	H	3.5	10.2	3.7	H	3.4	9.9	3.6
	I	5.3	15.4	5.5	I	5.3	15.4	5.5
	J	7.9	23.0	8.3	J	8.0	23.3	8.4
	VarmintV² LRF 35-640				VarmintV² LRF 50-640			
	A	200.6	583.5	210.0	A	140.6	409.0	147.2
	B	151.9	441.9	159.0	B	106.5	309.8	111.5
	C	35.9	104.4	37.6	C	25.2	73.3	26.4
	D	5.5	16.0	5.8	D	3.8	11.1	4.0
	E	11.0	32.0	11.5	E	7.7	22.4	8.1
	F	5.9	17.2	6.2	F	4.1	11.9	4.3
	G	8.8	25.6	9.2	G	6.2	18.0	6.5
	H	3.1	9.0	3.2	H	3.3	9.6	3.5
	I	5.5	16.0	5.8	I	5.5	16.0	5.8
	J	7.8	22.7	8.2	J	8.2	23.9	8.6
	VarmintV² LRF 35-384				VarmintV² LRF 50-384			
	A	99.7	290.0	104.4	A	69.9	203.3	73.2
	B	26.0	75.6	27.2	B	18.2	52.9	19.1
	C	3.1	9.0	3.2	C	2.2	6.4	2.3
VarmintV² LRF 35-640				VarmintV² LRF 50-640				
A	177.1	515.2	185.4	B	124.1	361.0	129.9	
B	43.3	126.0	45.3	C	30.4	88.4	31.8	
C	5.1	14.8	5.3	D	3.6	10.5	3.8	
	VarmintV² LRF 35-384				VarmintV² LRF 50-384			
	A	2.6	7.6	2.7	A	1.9	5.5	2.0
	B	26.5	77.1	27.7	B	18.6	54.1	19.5
	C	3.1	9.0	3.2	C	2.2	6.4	2.3
VarmintV² LRF 35-640				VarmintV² LRF 50-640				
A	4.7	13.7	4.9	A	3.3	9.6	3.5	
B	44.0	128.0	46.1	B	30.9	89.9	32.4	
C	5.5	16.0	5.8	C	3.8	11.1	4.0	
	VarmintV² LRF 35-384				VarmintV² LRF 50-384			
	A	4.8	14.0	5.0	A	3.4	9.9	3.6
	VarmintV² LRF 35-640				VarmintV² LRF 50-640			
A	8.1	23.6	8.5	A	5.7	16.6	6.0	

All data subject to change without notice.



AGM Global Vision, LLC

MAIN OFFICE

2407 E Interstate 30,
Suite 100

Grand Prairie, TX 75050

USA

Tel. +1.928.333.4300

info@agmglobalvision.com

www.agmglobalvision.com

EUROPEAN OFFICE

#6 Andrey Lyapchev Blvd

Sofia, P.C. 1756

Bulgaria

Tel. +35.988.560.0326

info@agmglobalvision.eu

www.agmglobalvision.eu

DOWNLOAD AGM CONNECT APP:



Google Play Store



Apple App Store

AGMglobalvision.com