

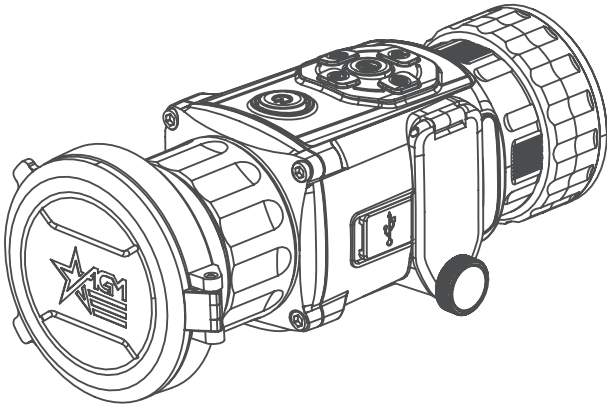

AGM
GLOBAL
VISION



RATTLER

TC35-640

TC50-640

THERMAL IMAGING CLIP-ON

USER MANUAL

© 2021 AGM Global Vision, LLC. All rights reserved.

This documentation is subject to change without notice.

No parts of this manual, in whole or in part, may be copied, photocopied, translated, or transmitted by any electronic medium or in machine-readable form without the prior written permission of AGM Global Vision, LLC.

If you have questions that are not covered in this manual, or need service, contact AGM Global Vision customer support for additional information prior to returning a product.

AGM Global Vision, LLC

173 West Main Street

PO Box 962

Springerville, AZ 85938

Tel. 928.333.4300

support@agmglobalvision.com

www.agmglobalvision.com

EXPORT INFORMATION

Buyer acknowledges that all products supplied by AGM Global Vision, LLC are subject to U.S. export control laws, including, but not limited to, the Export Administration Regulations, the International Economic Emergency Powers Act, and various U.S. embargoes and sanctions. AGM Global Vision products may not be exported, re-exported, or transferred contrary to U.S. export control laws. In particular, AGM Global Vision products may not be exported, re-exported, or transferred to prohibited countries, individuals, organizations, or entities, including but not limited to those individuals and entities listed on the List of Specially Designated Nationals and Blocked Persons administered or maintained by the U.S. Office of Foreign Assets Control ("OFAC"), the various lists maintained by the Bureau of Industry and Security of the Department of Commerce, and the U.S. State Department and Buyer represents and warrants that neither Buyer nor any of its officers, directors, or employees are on such lists. Distribution or resale by Buyer to such countries, individuals, organizations, or entities is expressly prohibited. Buyer has and will maintain a positive process to ensure compliance with this Section.

FCC INFORMATION

Please take attention that changes or modification not expressly approved by the party responsible for compliance could void the user's authority to operate the equipment.



This equipment complies with FCC/IC RSS-102 radiation exposure limits set forth for an uncontrolled environment.

FCC compliance: This product has been tested and found to comply with the limits for a Class B digital device, pursuant to Part 15 of the FCC Rules. These limits are designed to provide reasonable protection against harmful interference in a residential installation. This product generates, uses, and can radiate radio frequency energy and, if not installed and used in accordance with the instructions, may cause harmful interference to radio communications. However, there is no guarantee that interference will not occur in a particular installation. If this product does cause harmful interference to radio or television reception, which can be determined by turning the equipment off and on, the user is encouraged to try to correct the interference by one or more of the following measures:

- Reorient or relocate the receiving antenna.
- Increase the separation between the equipment and receiver.
- Connect the equipment into an outlet on a circuit different from that to which the receiver is connected.
- Consult the dealer or an experienced radio/TV technician for help.

FCC Conditions

This device complies with part 15 of the FCC Rules. Operation is subject to the following two conditions:

1. This device may not cause harmful interference.
2. This device must accept any interference received, including interference that may cause undesired operation.

EU CONFORMITY STATEMENT



This product and - if applicable - the supplied accessories too are marked with "CE" and comply therefore with the applicable harmonized European standards listed under the EMC Directive 2014/30/EU, the RoHS Directive 2011/65/EU



2012/19/EU (WEEE directive): Products marked with this symbol cannot be disposed of as unsorted municipal waste in the European Union. For proper recycling, return this product to your local supplier upon the purchase of equivalent new equipment, or dispose of it at designated collection points. For more information see: www.recyclethis.info



2006/66/EC (battery directive): This product contains a battery that cannot be disposed of as unsorted municipal waste in the European Union. See the product documentation for specific battery information. The battery is marked with this symbol, which may include lettering to indicate cadmium (Cd), lead (Pb), or mercury (Hg). For proper recycling, return the battery to your supplier or to a designated collection point. For more information see: www.recyclethis.info

INDUSTRY CANADA ICES-003 COMPLIANCE

This device meets the CAN ICES-3 (B)/NMB-3(B) standards requirements.

LIST OF CONTENTS

TITLE	PAGE
Safety Summary	5
1. GENERAL INFORMATION	7
1.1 System Description	7
1.2 Standard Components	8
1.3 Optional Equipment	8
1.4 Key Features	9
2. OPERATING INSTRUCTIONS	10
2.1. Basic Operations	10
2.2 Main Function	19
2.3 Client Software Introduction	26
3. MAINTENANCE	27
3.1 Maintenance	27
3.2 Troubleshooting	28
4. WARRANTY INFORMATION	29
4.1 Warranty Information and Registration	29
5. SPECIFICATIONS	31
5.1 Specifications	31

SAFETY SUMMARY

- Read and follow all instructions
- Read all warnings
- Only use the attachments/accessories specified by the manufacturer
- All service must be provided by the manufacturer

WARNING:

This product contains natural rubber latex, which may cause potentially fatal allergic reactions! If you are allergic to latex, it is important that you strictly avoid exposure to products that contain it.

WARNING:

Always make sure your firearm is unloaded before you place the scope on the firearm. Reconfirm that the chamber is empty if you stop the procedure then resume later. Safe handling rules should be followed at all times.

WARNING:

If a scope is mounted too far to the rear, the eyepiece can injure the shooter's brow. Shooting at an uphill angle also increases this hazard because it shortens the distance between the brow and the rear of the scope. For this reason, AGM scopes are engineered to provide generous eye relief. Therefore, when mounting your scope, we recommend positioning it as far forward in the mounts as possible to take full advantage of this generous eye relief. With hard-recoiling rifles, serious injury or even death can result from eyepiece impact with the shooter during the recoil process when discharging the firearm. Be certain that your installation provides sufficient eye relief for the recoil generated by your rifle before shooting the firearm.

NOTE: Give special attention to this warning when shooting uphill and/or from a prone position. These shooting conditions can dramatically reduce eye relief. PLEASE maintain maximum eye relief when shooting heavy recoiling and/or magnum firearms. THE USER ASSUMES ALL RESPONSIBILITY AND LIABILITY FOR HAVING THE AGM SCOPE PROPERLY MOUNTED TO A FIREARM AND USING THE AGM SCOPE PROPERLY. ALWAYS CHECK THE CONDITION OF YOUR MOUNTING SYSTEM PRIOR TO USING YOUR FIREARM.

WARNING:

The proper usage of the device is important for safe operation! Therefore carefully read this manual!

WARNING:

If the device was left in storage for a longer period of time, before use, check its functionality.

WARNING:

Disassembling of the device is prohibited, except in authorized repair centers.

WARNING:

Please remove the batteries from the battery compartment before connecting the device to your PC, or it may cause computer damage.

WARNING:

The external optical surfaces should be clean at all times. Touching the optical surfaces with bare hands is not recommended.

WARNING:

Sand and sea water can damage the optical coatings!

WARNING:

Do not point the device directly at the sun!

WARNING:

Image performance is dependent on scenery and atmosphere conditions. Contrast in the same image may vary as a function of the time of day due to the effect of the sun. For example, at sunset objects will have absorbed different levels of heat resulting in greater temperature differences and better contrast.

WARNING:

When left in storage for a longer period of time, batteries have to be removed and stored in polyethylene bags to prevent contact with metal. (It is recommended to recharge the batteries every two to three months.)

WARNING:

When carrying or transporting the device, put the protective lens cap on!

WARNING:

Condensation can cause fogging of the optical surfaces! Condensation occurs when the temperature or humidity changes as follows:

- When moving the device from cold to warm place or vice versa;
- In places with high humidity.

When equalizing the temperature of the device with the environmental, the condensation disappears. Use the towel to remove moisture.

NOTES:

- The detector spectral band provides better visibility through smoke, dust, rain, smog, etc.
- Infrared radiation does not travel through glass. As a result, the clip-on does not detect objects if they are behind glass windows or other barriers.

WARNING:

Clean the lens surfaces with the lens tissue or a dry cloth!

LEGAL NOTICE

Before attaching to weapons, check the regional legal regulations in the area of application. The attachment to a weapon is always the sole responsibility of the user.

1 GENERAL INFORMATION

1.1 SYSTEM DESCRIPTION

The AGM Rattler TC35-640 and Rattler TC50-640 are the compact thermal imaging clip-on systems that allows quick transformation of the day optics into thermal imaging device without any special tools or equipment.

Rattler TC35-640 and Rattler TC50-640 clip-ons have high sensitivity $12\mu\text{m}$ thermal detector with 640×512 resolution and 1024×768 OLED monitor, which provides clear image under harsh environment conditions like darkness, fog, smoke, dust, rain, snow, wood, camouflage, etc. The clip-on can easily be attached in front of day scopes with magnification up to 8x for long range use.

The device supports pallet switch and distance measurement function. The Rattler TC detects and marks the hot spot of highest temperature. Built-in memory module supports video recording and snapshot capturing. Wi-Fi module for live video streaming and video/images recording via application is also available.

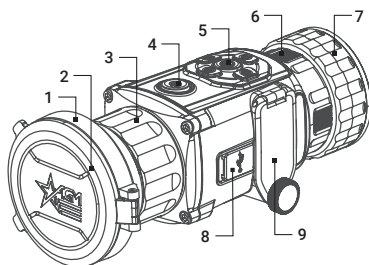

FIGURE 1-1. MAIN PARTS

TABLE 1-1. MAIN PARTS

ITEM	DESCRIPTION
1	Objective Lens
2	Objective Lens Cover
3	Objective Focus Ring
4	Power Button
5	Operation Buttons

ITEM	DESCRIPTION
6	Output Lens
7	Adapter Fixing Ring
8	USB Type-C Interface (closed with a cover)
9	Battery Compartment

1.2 STANDARD COMPONENTS

The Rattler standard components are shown in Figure 1-2 and listed in Table 1-2.

The ITEM column indicates the number used to identify items in Figure 1-2.

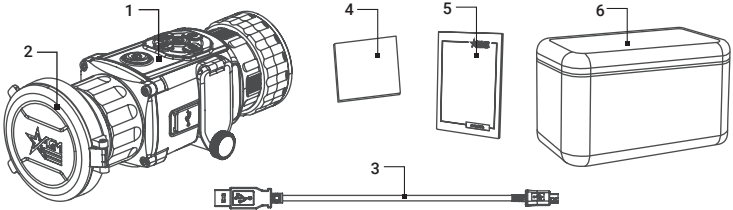

FIGURE 1-2. STANDARD COMPONENTS

TABLE 1-2. STANDARD COMPONENTS

ITEM	DESCRIPTION	QUANTITY
1	Rattler Thermal Imaging Clip-On system	1
2	Objective Lens Cap	1
3	USB Cable	2
4	Lens Tissue	1
5	User Manual	1
6	Carrying Case	1

1.3 OPTIONAL EQUIPMENT

Optional items are shown in Figure 1-3 and listed in Table 1-3.

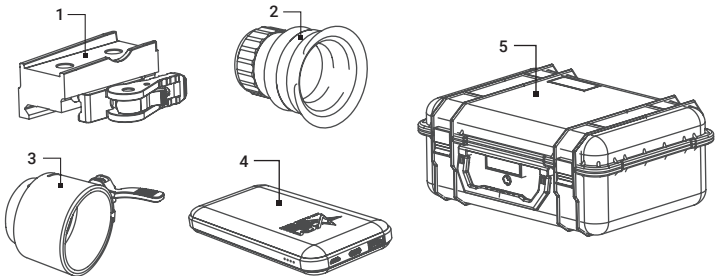

FIGURE 1-3. OPTIONAL EQUIPMENT

TABLE 1-3. OPTIONAL EQUIPMENT

ITEM	DESCRIPTION	PART NO.
1	AGM-2113 ADM Short QR Mount for Rattler	6306LSR1
2	Eyepiece for Rattler TC	6328ERC1
3	Front Q-R adapter for Rattler TC: ARM52-56	6306RC61
	Front Q-R adapter for Rattler TC: ARM52-50	6306RC51
	Front Q-R adapter for Rattler TC: ARM52-44	6306RC41
	Front Q-R adapter for Rattler TC: ARM52-30	6306RC31
4	AGM Power Bank	6308EPB1
5	Hard Case for Storage/Transportation	6610HCS1

1.4 KEY FEATURES

- Quick conversion of daytime optics into thermal imaging scope
- Mounts in front of any daytime scope, no re-zeroing is required
- 12 μ m high-sensitivity detector
- 640 \times 512 thermal resolution
- Fast 50 Hz imaging
- 1024 \times 768 resolution OLED display
- Lightweight and compact design
- Easy to operate control
- Adjustable color palettes
- Automatic or manual (silent) calibration
- Video recording and snapshot
- Built-in EMMC memory (16 GB)
- Wi-Fi data transmission
- Stadiametric rangefinder
- Standby mode
- Waterproof, shockproof
- Powered by two standard CR123A or RCR123 rechargeable batteries
- Up to 4.5 hours continuous working
- External power supply capability
- Limited 3-year warranty

2 OPERATING INSTRUCTIONS

2.1. BASIC OPERATIONS

2.1.1 UNPACKING

The following steps must be completed prior to each mission.

1. Open the carrying case, remove the device, and verify that all components are included.
2. Inspect the device for any obvious evidence of damage to the optical surfaces, body, eyecup, operation buttons, etc. Ensure that all optical surfaces are clean and ready for use. Clean all optical surfaces with a lens tissue.

2.1.2 BATTERIES INSTALLATION

CAUTION:

Verify that the equipment is OFF before remove the batteries.

To install the batteries (refer to Figure 2-1):

1. Turn the battery cover knob (A) counter clockwise and then open the battery cover (B).
2. Install two CR123A or RCR123 batteries (C) into the battery compartment. Align the polarity symbols on the batteries as shown below.
3. Close the battery cover. Turn the battery cover knob clockwise until stop.

When the device is on a battery charge level is displayed on the status bar.

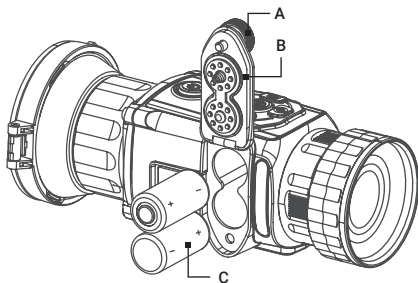





FIGURE 2-1. BATTERY INSTALLATION

2.1.3 SELECT BATTERY TYPE

You can change the battery type according to your need. Select the correct battery voltage in the device menu.

1. In the view mode, hold  button to show the menu.
2. Select  Battery Voltage menu item, and press  button to switch the voltage.

2.1.4 CONNECTING THE DEVICE

WARNING:

Please remove the batteries from the battery compartment before connecting the device to your PC, or it may cause computer damage.

1. Open the cable interface cover.
2. Connect the device and power adapter with a Type-C cable to power on the device. Alternatively, connect the device and PC to copy/delete files.

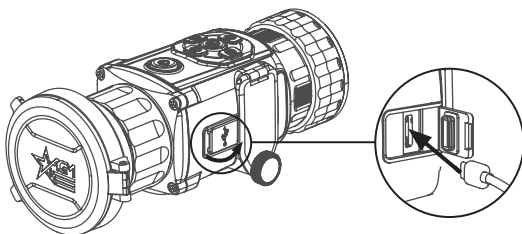

FIGURE 2-2. CABLE INTERFACE

2.1.5 CONTROL BUTTONS

The Rattler controls are shown in Figure 2-3 and are defined in Table 2-1.

Each button is responsible for some functions selected by short press or long press of the button. Pushing a button for 3+ second is considered "Long Press/ Hold."

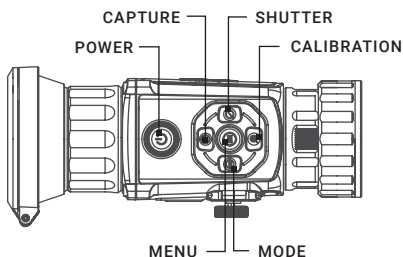









FIGURE 2-3. CONTROL BUTTONS

TABLE 2-1. BUTTON FUNCTIONS

BUTTON	FUNCTIONS
 POWER	Press: Sleep Mode/Wake Up Device Hold: Power On/Off
 MENU / SELECT	Press: Enable/Disable OSD Hold: Menu Operation
 MODE / LEFT	Press: Switch Palettes Hold: Enable/Disable PIP
 CAPTURE / UP	Press: Capture Hold: Start/Stop Record Video
 SHUTTER / RIGHT	Press: Correct Non-uniformity of Display
 CALIBRATION / DOWN	Press with Capture button together to launch the Image Calibration menu.

2.1.6 POWER ON AND OFF

Power On

Hold the POWER button  for 4 seconds to power on the device. An image will appear on the display.

Refer to the figure below for the main view of the clip-on display.

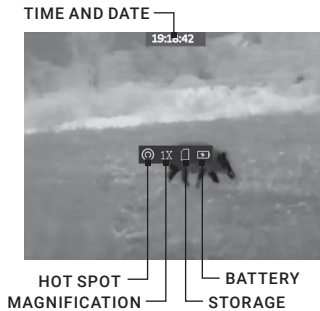



FIGURE 2-4. THE DISPLAY MAIN VIEW

Power Off

When the device is turned on, hold  button for 4 seconds to power off the device.

In the "Auto Power Off" menu you can set the time for the automatic shutdown of the device as required (OFF / 30 min / 45 min).

2.1.7 SLEEP MODE

In the view mode, press the  button. After a few seconds, the display will turn off. Press the  button again to exit the Sleep Mode.

2.1.8 THERMAL VIEW OBSERVATION

1. Install the Rattler TC on the weapon with a day scope (refer to part 2.1.15 or 2.1.16). Verify that the Rattler TC is securely mounted.
2. Remove the protective caps.
3. Point the equipment at an object.
4. Activate the Rattler TC. After approximately 4 sec, video of the thermal scene should appear.
5. If the day scope includes a focusing ring (i.e., parallax adjustment knob), adjust the focus for a parallax-free image.
6. Turn on the day scope's reticle illumination and adjust the reticle brightness.
7. Adjust the focus of Rattler TC by turning the focus ring.
8. Using the buttons on the control panel, configure the Rattler TC for your specific situation. Set palette, brightness, contrast, scene mode and FFC (Flat Field Correction), to display the best image effect.

For more information on operational setting procedures, see Part 2.2 (Main Functions).

2.1.9 PALETTE SETTINGS

You can select different palettes to display the same scene in different effects. Press  button in the view mode to switch palettes.

TABLE 2-2. PALETTE SETTINGS

PALETTE	DESCRIPTION
WHITE HOT	The hot part is white-colored in view. The higher the temperature is, the lighter the color is.
BLACK HOT	The hot part is black-colored in view. The higher the temperature is, the darker the color is.
FUSION	The hot part is white-colored. From high temperature to low temperature, the image is colored in from white, yellow, red, pink to purple.
RED HOT	The hot part is red-colored in view. The higher the temperature is, the redder the color is.

2.1.10 ON-SCREEN DISPLAY

Press  button in the view mode to display or hide the OSD (On-Screen Display) information.

When OSD is on, the information of Wi-Fi hotspot activation, storage memory status, and battery status displays in top right corner of viewfinder.

2.1.11 SHUTTER RELEASE

Press  button in the view mode to release the shutter once for correction of the non-uniformity of display.

2.1.12 VIDEO RECORDING / IMAGE CAPTURE

Video Recording

Hold  button in the view mode and start recording. In the upper left corner, the recording time displays.



Hold  button again to stop recording.



FIGURE 2-5. VIDEO RECORDING

Image Capturing

Press  button in the view mode, to capture the image.

NOTE:

- When captured, the image freezes for 1 second and a prompt shows on the display.
- For exporting captured images, refer to File Export.

2.1.13 FILE EXPORT

WARNING:

Please remove the batteries from the battery compartment before connecting the device to your PC, or it may cause computer damage.

1. Before connecting the thermal clip-on to a computer, please make sure that the Wi-Fi function of the clip-on is disabled.
2. Connect the thermal clip-on to your PC with USB cable and open the detected disk.
3. The directory is named by the current date. Enter DCIM > "Date" to view the videos and snapshots.
 - Select and copy the videos to PC and play the file with the player.
 - Select and copy the snapshots to PC and view the files.
4. Disconnect the device from your PC.

NOTE:

- The device displays images when you connect it to PC. But functions such as recording, capturing and hot spot are disabled.
- When you connect the device to PC for the first time, it installs the driver automatically.

2.1.14 IMAGE CALIBRATION

Press \oplus and \odot buttons together in the view mode to display the Image Calibration menu.

Use Image Calibration to solve the problem of shooting deviation and to achieve better accuracy.

For more information on Image Calibration procedures, see Part 2.2.8.

2.1.15 INSTALLING THE CLIP-ON ONTO THE LENS OF A DAY SCOPE

WARNING:

Always make sure your firearm is unloaded before you place the scope on the firearm. Reconfirm that the chamber is empty if you stop the procedure then resume later. Safe firearms handling rules should be followed at all times.

Use the optional Front Q-R adapter to install the Rattler TC onto day scope lenses.

ATTENTION:

The day scope front adapters are not recommended for installing the Rattler TC on firearms with heavy dynamic recoil (.308 Win or stronger).

NOTE:

The Rattler TC cannot be attached to scopes that include focus rings on the housing of the objective lens.

NOTE:

The adapter must fit with the diameter of the day scope front lens. There are various optional day scope front adapters available for a wide range of objective lens diameters.

Install the optional Front Q-R adapter to the Rattler as follows (refer to Figure 2-6):

1. Align the pins of the reducing ring (A) with the bayonet grooves in the Rattler's output lens attachment place. This position is marked with a red dot on the ring and output lens.

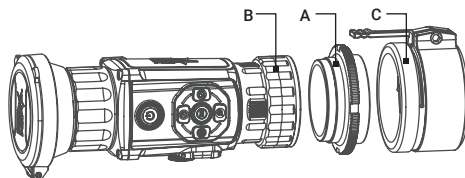

FIGURE 2-6. FRONT Q-R ADAPTER INSTALLATION

2. Insert the reducing ring to the grooves and then turn it clockwise as far as it will go.
3. Rotate the Rattler's fixing ring (B) clockwise to tighten it on the reducing ring thread. Please note the fixing ring has left-hand thread. Be careful not to overtighten the fixing ring.
4. Screw the front adapter (C) into the reducing ring.

NOTE:

Different models of front adapters may have different designs. Refer to the user manual for your adapter for correct installation.

Install the Rattler TC on the lens of a day scope as follows (refer to Figure 2-7):

1. Turn the lever (A) of adapter (B) backwards to loosen the adapter clamping device.
2. Slide the Rattler TC with the adapter onto the lens of the day scope (C) as far as it goes.
3. Affix the clip-on to the day scope by locking the lever (A) of adapter.
4. Rotate the clip-on to align its vertical position. Tighten the lock nut (D) tightly with the special wrench to secure the position.
5. Verify that the clip-on is firmly secured to the day scope.

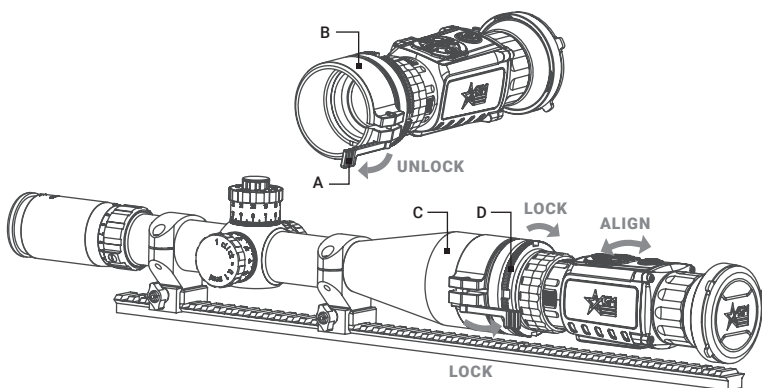

FIGURE 2-7. CLIP-ON INSTALLATION

NOTE:

AGM recommends that you use an eyecup on the day scope's eyepiece for maximum safety and comfort, as well as to escape detection.

2.1.16 INSTALLING THE RATTLER ON A PICATINNY/WEAVER RAIL

Use the optional quick release mount (QR mount) to install the Rattler TC on a Picatinny/Weaver rail. The mount can be attached to the scope with two screws (Figure 2-8).

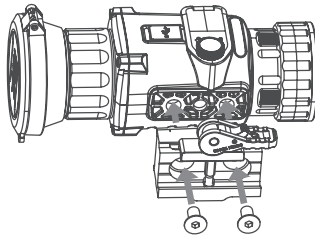

FIGURE 2-8. QUICK RELEASE MOUNT INSTALLATION

To install the Rattler TC on a Picatinny/Weaver rail, perform the following (Figure 2-9):

1. Unlock the clamping device of the scope mount by pushing down on the lever holder (A) and unlocking the lever (B).
2. Install the scope on the Picatinny/ Weaver rail so that the stop (C) slides into the transverse slot on the rail.
3. Affix the scope to the rail by locking the lever (B).
4. Verify that the clamping device is firmly holding the Rattler. If necessary, adjust the clamping device's lever-cam lock.

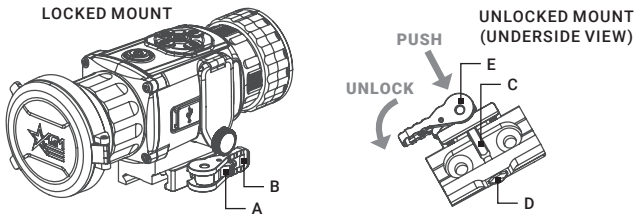

FIGURE 2-9. OPERATION OF THE QR MOUNT

To adjust the mount's clamping device, do the following:

1. Remove the Rattler from the weapon.
2. With the clamping device unlocked (as shown in Figure 2-9), push the cam (E) towards the arrow, which will cause the nut (D) to slide out of its hole.
3. To tighten/ loosen the clamping device, push down on the cam (E) and turn the nut (D) CW/ CCW respectively, in one-two increments (see note below). Much like when the cam (E) is released, backward-moving spring will cause the nut (D) to slide back into its hole.

NOTE:

The eight-sided nut of the mount lever-cam lock will only fit into their hole if turned in one of the discrete positions, using increments equal to $360^\circ/8$.

4. Verify that the lever-cam lock securely holds the weapon mounting rail.

NOTE:

The optical axis of the Rattler TC and day scope should be aligned. The distance between the axis should not exceed 3 mm. If the difference in the axis heights of the Rattler TC and day scope above the weapon rail exceeds 3 mm, you will need to replace the day scope mounting rings or monoblock.

2.1.17 THERMAL VIEW OBSERVATION

1. Install the Rattler TC on the weapon with a day scope (refer to part 2.1.15 or 2.1.16). Verify that the Rattler TC is securely mounted.
2. Remove the protective caps.
3. Point the equipment at an object.
4. Activate the Rattler TC. After approximately 4 sec, video of the thermal scene should appear.
5. If the day scope includes a focusing ring (i.e., parallax adjustment knob), adjust the focus for a parallax-free image.
6. Turn on the day scope's reticle illumination and adjust the reticle brightness.
7. Adjust the focus of Rattler TC by turning the focus ring.
8. Using the buttons on the control panel, configure the Rattler TC for your specific situation. Set palette, brightness, contrast, scene mode and FFC (Flat Field Correction), to display the best image effect.

For more information on operational setting procedures, see Part 2.2 (Main Functions).

2.1.18 EYEPIECE REPLACEMENT

The device can be used as a clip-on scope or a handheld observation camera. You can replace the eyepiece to realize different uses of the device.

1. Rotate the fixing ring (Figure 2-10, A) of clip-on output lens (B) counter clockwise to remove it.
2. Align the optional monocular eyepiece (C) with the grooves (D) of device, and rotate the fixing ring of eyepiece (E) clockwise to tighten it.

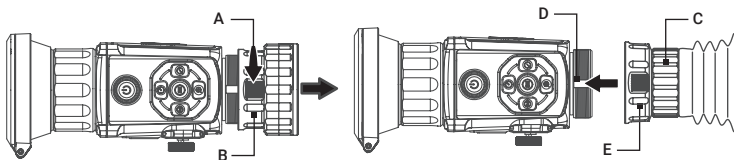





FIGURE 2-10. EYEPIECE REPLACEMENT

2.2 MAIN FUNCTIONS

2.2.1 MENU OPERATION

When the device powers on, hold  button in the view mode for 4 seconds to display the menu.

Press  and  buttons to move between menu items. The active element is highlighted in orange. Press  button to select menu item or change an option.

Hold  button to save settings and exit the menu.

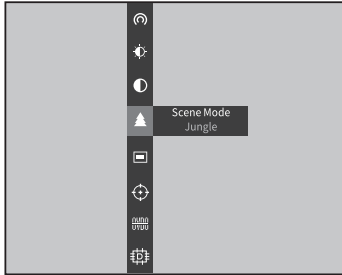

























FIGURE 2-11. MAIN MENU



TABLE 2-3. MENU FUNCTION

MENU ITEM	SYMBOL	OPTION	FUNCTION
BATTERY VOLTAGE		3.0 V / 3.7 V	Select the battery voltage.
NETWORK		OFF	Enable or disable the Wi-Fi hotspot.
		Hotspot	
CONTRAST		5 Levels of contrast	Adjust the image contrast.
BRIGHTNESS		5 Levels of brightness	Adjust the image brightness.
SCENE MODE		Recognition	Switch between the Recognition mode and Jungle mode.
		Jungle	
PIP		UP-Left / Center / UP-Right / Close	Enable or disable the PIP function. Set the position of the PIP window.
FFC		Auto / Manual / External	Select the Flat Field Correction (FFC) mode.

MENU ITEM	SYMBOL	OPTION	FUNCTION
CVBS		OFF	Turn on and off the CVBS Output function to view the video on CVBS monitor.
		ON	
DPC		---	Correct dead pixel manually.
AUTO POWER OFF		OFF/30 min/ 45 min	Set the automatic shutdown time.
BURN PREVENTION		ON	Turn on and off the Burn Prevention function.
		OFF	
VERSION		---	View the firmware version number and serial number.
RESTORE		---	Restore the device to defaults.
LANGUAGE		17 Languages	Select the language of interface.
TIME SYNC.		Time Format / Time / Date	Set the time and date.
OSD		OSD / Time / Date	Enable or disable OSD, time, date.
MEASURE		0.8 m/1.2 m/ 1.8 m/3.0 m Target Height	Enter distance measurement mode.
HOT TRACKING		OFF	Enable/disable hot spot mark (marking the spot of highest temperature).
		ON	



2.2.2 BATTERY TYPE

You can change the battery type according to your need. Select the correct battery voltage in the device menu.

1. Hold  button in the view mode to show the menu.
2. Select  Battery Voltage menu item, and press  button to switch the battery voltage.

2.2.3 NETWORK CONFIGURATION

Connect your phone or tablet to the Wi-Fi hotspot of the clip-on, you can configure the parameters and realize functions of the device.



1. Hold  button to show the menu.
2. Select  menu item to enable Wi-Fi hotspot function.

3. Turn on the WLAN and connect to the Wi-Fi hotspot.
 - Hotspot Name: Wlan-IPTS Serial No.
 - Hotspot Password: Last 9 digits of Serial No.
4. Search T-Vision client software on App Store (iOS System) or Google Play™ (Android System) to download and install the app.
5. Run the app and connect your phone or tablet with the device. You can view the interface of clip-on on your phone.



NOTE:

When the power is less than 15%, the Wi-Fi hotspot function will be turned off automatically.

2.2.4 CONTRAST ADJUSTMENT





1. Hold  button to go to the menu.
2. Select  Contrast menu item and press  button to adjust the image contrast. You can select one of five levels of the contrast.

2.2.5 BRIGHTNESS ADJUSTMENT

1. Hold  button to show the menu.
2. Select  Brightness menu item and press  button to adjust the brightness. In White Hot mode, you can select one of five levels of the brightness to adjust the image lighter or darker. In Black Hot mode, the brightness of the image turns in the opposite way.

2.2.6 SCENE MODE

You can select proper Scene Mode according to environment temperature to improve the display effect.





1. Hold  button to show the menu.
2. Select  /  Scene Mode menu item ( is default option) and press  button to switch scene.

Recognition mode () improves an image so that the object edge is more distinct.

Jungle mode () is more suitable for hunting environment because of the highlight function of small objects.

3. Hold  for 4 seconds to save settings and exit.







2.2.7 PICTURE IN PICTURE MODE

1. Hold  button to show the menu.
2. Select  PIP menu item and enter Picture In Picture (PIP) mode. The details show in the upper part of screen.
3. Press  button to activate or deactivate PIP mode.
4. Hold  button to exit.

You can quickly enable or disable the PIP function by holding down the  button in the view mode.

2.2.8 FLAT FIELD CORRECTION

Flat Field Correction (FFC) function can correct non-uniformity of display.

1. Hold  button to show the menu.
2. Select  FFC menu item and press  button to switch the FFC mode.
Auto: The clip-on performs FFC automatically when switching on or rebooting the camera.
Manual: Press  button in live view to correct the non-uniformity of display.
External: Cover the lens cap, then press  button in live view to correct the non-uniformity of display.
3. Hold  button to confirm the setting and exit.

2.2.9 CVBS OUTPUT

You can view the video on CVBS monitor, to get a better and clear image, more convenient to check the detail.



1. Connect the USB-CVBS cable to USB port of thermal clip-on and to monitor's CVBS port.

NOTE:

USB-CVBS cable need to be purchase separately.

NOTE:









CVBS Output function doesn't support hot plug, so please connect the cable before powering on.

2. Hold  button to show the menu.
3. Select **CVBS** menu item and press  button to turn on or turn off the CVBS video output.

2.2.10 DEFECTIVE PIXELS CORRECTION



Defective Pixels Correction (DPC) function can correct the defective pixels on the screen which have not performed as expected.

Before you start switch the palette to White Hot mode.

1. Hold  button to show the menu.
2. Select  DPC menu item and press  button.
3. Press , ,  and  buttons to move the cursor to the position of dead pixel.
4. Hold  button to correct the dead pixel.





2.2.11 AUTO POWER OFF

You can set the time for the automatic shutdown of the device as required.



1. Hold  button to show the menu of device.
2. Select  Auto Power Off menu item and press  button to select OFF, 30 min or 45 min.

2.2.12 BURN PREVENTION

You can protect the thermal clip-on under the sun or other bright light with high temperature that could leave a damage to the clip-on. When you point the device directly at the heat, the shutter will be released and cover the sensor to protect it. It resumes once the environment turns to normal.



1. Hold  button to show the menu.
2. Select  Burn Prevention menu item and press  button to turn on or turn off the Burn Prevention function.
3. Hold  button to exit.

2.2.13 VIEW DEVICE INFORMATION

1. Hold  button to show the menu of device.
2. Select  Version menu item and press  button. You can view the device information such as firmware version, and serial number.





2.2.14 RESTORE DEVICE

You can reset the settings of device.

1. Hold  button to show the menu of device.
2. Select  Restore menu item and press  button to restore the device to defaults according to the prompt.







2.2.15 LANGUAGE SETTING

You can select different languages of user interface.

1. Hold  button to show the menu.
2. Select  Language menu item and press  button to select the language. The following languages are supported: English, Russian, German, Czech, French, Spanish, Danish, Norwegian, Swedish, Finnish, Hungarian, Italian, Polish, Portuguese, Romanian, Slovak, Spanish.
3. Hold  button to save settings and exit.

2.2.16 TIME SYNCHRONIZATION

You can display the date and time on the screen. 24-hour and 12-hour time format are available.

1. Hold  button to show the menu.
2. Select  menu and press  button to enter the Time Sync.
3. Press  or  buttons to select the time format, time or date. Press  button to switch and confirm.

2.2.17 ON-SCREEN DISPLAY

You can display the information of Wi-Fi hotspot activation, current magnification, storage memory status, battery status, time and date in top of viewfinder.

1. Hold  button to show the menu.

2. Select  OSD menu item and press  button to enable or disable OSD.
3. Hold  button to exit.

2.2.18 DISTANCE MEASUREMENT

You can detect the distance between the target and the observation position.

NOTE:

When measuring the distance, keep your hand and the position steady. Otherwise, the accuracy may be affected.











1. Hold  button to show the menu.
2. Select  menu item and press  button to enter the Distance Measurement mode.
3. Press  button to go to the target setting interface.
 - 1) Press  or  to select the target from Wolf (0.8 m), Bear (3.0 m), Deer (1.2 m), and Custom (1.8 m). Each target preset can be modified from 0.1 to 9.9 m.
 - 2) Set the target and press  button to confirm.
4. Align the center of top mark with the edge of target top. Press  button.
The cursor blinks on the top edge of the target.



FIGURE 2-12. DISTANCE MEASUREMENT



5. Align the center of bottom mark with the edge of target bottom. Press  button.
The left top of the image displays the distance measurement result and the height of the target.



NOTE:

Go to distance measurement interface, and press  button to view the result of the previous measuring target.

2.2.19 HOT TRACKING

The device can detect the highest temperature spot in the scene and mark it on display.

1. Hold  button to show the menu.
2. Select  and press  button to enable/disable hot spot mark (marking the spot of highest temperature).

When the hot spot mark is enabled, the  mark displays in the spot of the highest temperature. When the scene changes, the  mark moves.

2.2.20 ELECTRONIC ACCURACY CORRECTION

After mounting of clip-on to the weapon with day scope the clip-on optical axis can be offset off scope optical axis. The Image Calibration function supports manually adjusting the position of the live preview window by pressing the buttons up, down, left, and right. The image region could be adjusted in 4 directions in the whole OLED screen area.

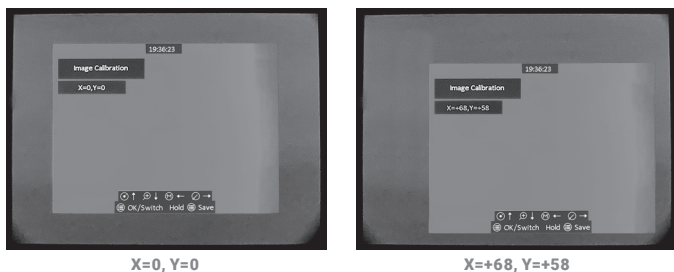

FIGURE 2-13. IMAGE CORRECTION

Adjust the electronic accuracy correction as follows:

1. Aim your day scope to the middle of target and shoot. This action will test the control of day scope accuracy.
2. Mount the Rattler TC on the day scope. Aim at the center of the target and shoot again.
3. Press \oplus and \odot buttons together in the view mode to display the Image Calibration menu.
4. Press \odot or \ominus buttons to move image in horizontal direction. Press \oplus or \ominus buttons to move image in vertical direction.

While using the Image Calibration, the display shows value of axis X (horizontal) and Y (vertical). One step of image calibration means 0.25 mil / 0.86 MOA / 2.5 cm at 100 m distance / 0.86 in at 100 yd distance.

5. Hold \odot button to restore default settings (X=0, Y=0).
6. Press \equiv button to save image position and exit Image Correction menu.

For example:



When the point of impact with Rattler is 5 cm on the right side and 7.5 cm on the up side of previous point of impact (previous aiming position), move the image to the right by pressing \odot button 2 times (the X value will increase by two), and move the image up by pressing \oplus button 3 times (the Y value will decrease by three).

2.3 CLIENT SOFTWARE INTRODUCTION

Install T-Vision client software on your mobile phone first, and then connect your phone to the hotspot of the clip-on. Refer to chapter 2.2.3 for details of hotspot connection.

NOTE:

The device password is set by user at first activation. If the password was lost or forgotten, it can be reset. To make a reset, provide the following action:

1. When the clip-on is turned on, hold  button to activate the OSD menu.
2. Select  menu item and press  button to restore all parameters to default settings.

1. Run the app and connect the phone or tablet with the device.
2. If the device is inactivated, set the password and activate it. If the device is activated, enter the password to add it to the app.
3. When the device is added, the live view can be seen. You can view the interface of the clip-on on the software. User can change such image parameters as brightness, contrast, zoom, palettes directly via phone or tablet as well as record video on phone/tablet memory.

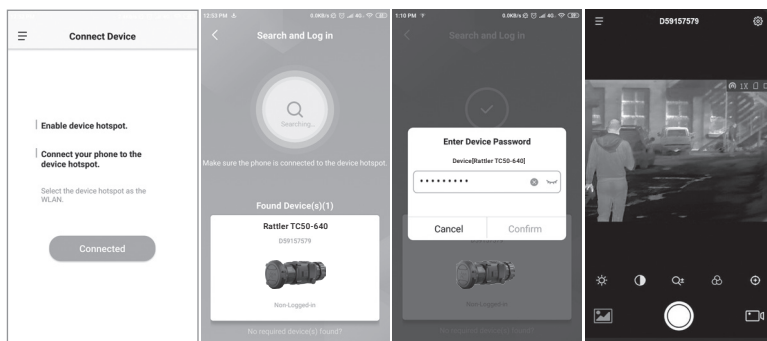

FIGURE 2-14. CLIENT SOFTWARE

3 MAINTENANCE

3.1 MAINTENANCE

3.1.1 CLEANING PROCEDURES

1. Gently brush off any dirt from the body of the device using a clean, soft cloth.
2. Moisten the cloth with fresh water and gently wipe down the external surfaces (except lenses).
3. Dry any wet surfaces (except lenses) using another dry, clean, soft cloth.
4. Using a lens brush, carefully remove all loose dirt from the lenses.
5. Use a high quality lens wipe to remove dirt or smudges from the lens and display window. Do not use abrasives or solvents to clean the housing, lens, or display window. Clean the glass surfaces using circular movements, starting from the center of the lens and moving out towards the edge.
6. Clean the accessories with a soft brush (or cloth) dampened with soap and water.

3.1.2 PREPARING FOR EXTENDED STORAGE

CAUTION:

Thoroughly dry each item before placing them into the storage case.

To prepare the clip-on for extended storage:

1. Clean the clip-on and accessories.
2. Place all items into the storage case.

3.1.3 UPGRADE DEVICE

WARNING:

Please remove the batteries from the battery compartment before connecting the device to your PC, or it may cause computer damage.

If you removed the batteries, please make sure the device is connected to the computer during the update process. Otherwise, the device will shut off and may cause unnecessary upgrade failure, firmware damage, etc.

1. Download the upgrade package to your PC and unzip it. (Do not open the DAV or BIN file on your computer as it may corrupt the file.)
2. Connect the thermal device to your PC with USB cable.
3. Turn on the thermal device.
4. Disable the Wi-Fi Hotspot function in the device menu if Wi-Fi is enabled.
5. Open the detected disk (USB drive) in file manager program. Copy the unzipped .dav file and paste it to the root directory of the device.

6. Turn off the device.
7. Turn on the device. After a while, the firmware update process will start automatically. During the update, the screen will display the inscription "Upgrading ...". The update process will be completed when the word "Upgrading ..." goes out.

Repeat steps 5-7 for each updating file.

3.2 TROUBLESHOOTING

Table 3-1 lists the most common malfunctions that may occur with your equipment. This table does not list all the malfunctions that may occur with your device. If the equipment malfunction is not corrected by the suggested actions, or a problem occurs that is not listed in this table, please contact AGM Global Vision's Customer Support center or your retailer.

TABLE 3-1. TROUBLESHOOTING

MALFUNCTION	CORRECTIVE ACTION
The Rattler TC fails to activate.	<ol style="list-style-type: none"> 1. Batteries are missing or improperly installed. Insert batteries or install correctly. 2. Batteries are dead. Replace the batteries. 3. Batteries, surfaces or contacts are dirty or corroded. Clean the contact.
The Rattler TC shut off some-times after shot.	<ol style="list-style-type: none"> 1. Wrong battery voltage. The default is 3.0 V. If you use 3.7V battery, switch it in the menu. 2. Improper dimension of the battery. Check if there is the rubber ring attached on the battery compartment. 3. Low battery level. Check the remaining capacity of the batteries, which may be low on power to maintain performance.
The image is not clear.	Perform the sight adjustment referring to section 2.1.
Wi-Fi is not found.	Examine whether the Wi-Fi function is turned on. If not, go to OSD menu and turn on Wi-Fi.
Capturing or recording fails.	<ol style="list-style-type: none"> 1. The device is connected to your PC and has disabled the capturing and recording. 2. The storage space is full. 3. The device is in a low-battery condition.
The PC cannot identify the Rattler TC.	<ol style="list-style-type: none"> 1. The device is connected to your PC with standard USB cable. 2. If you use other USB cables, make sure the cable length is no longer than 1 m. 3. The Wi-Fi function is turned on. If so, go to OSD menu and turn off Wi-Fi.

4 WARRANTY INFORMATION

4.1 WARRANTY INFORMATION AND REGISTRATION

4.1.1 WARRANTY INFORMATION

This product is guaranteed to be free from manufacturing defects in material and workmanship under normal use for a period of three (3) years from the date of purchase. In the event that a defect covered by the warranty below occurs during the applicable period stated above, AGM Global Vision, at its discretion, will either repair or replace the product; such action on the part of AGM Global Vision shall be the full extent of AGM Global Vision's liability, and the Customer's sole and exclusive reparation. This warranty does not cover a product if it has been (a) used in ways other than its normal and customary manner; (b) subjected to misuse; (c) subjected to alterations, modifications or repairs by the Customer or by any party other than AGM Global Vision without prior written consent of AGM Global Vision; (d) is the result of a special order or categorized as "close-out" merchandise or merchandise sold "as-is" by either AGM Global Vision or the AGM Global Vision dealer; or (e) merchandise that has been discontinued by the manufacturer and either parts or replacement units are not available due to reasons beyond the control of AGM Global Vision. AGM Global Vision shall not be responsible for any defects or damage that in AGM Global Vision's view are a result from the mishandling, abuse, misuse, improper storage or improper operation of the device, including use in conjunction with equipment that is electrically or mechanically incompatible with, or of inferior quality to, the product, as well as failure to maintain the environmental conditions specified by the manufacturer. This warranty is extended only to the original purchaser. Any breach of this warranty shall be enforced unless the customer notifies AGM Global Vision at the address noted below within the applicable warranty period.

The customer understands and agrees that except for the foregoing warranty, no other warranties written or oral, statutory, expressed or implied, including any implied warranty of merchantability or fitness for a particular purpose, shall apply to the product. All such implied warranties are hereby and expressly disclaimed.

4.1.2 LIMITATION OF LIABILITY

AGM Global Vision will not be liable for any claims, actions, suits, proceedings, costs, expenses, damages, or liabilities arising out of the use of this product. Operation and use of the product are the sole responsibility of the Customer. AGM Global Vision's sole undertaking is limited to providing the products and services outlined herein in accordance with the terms and conditions of this Agreement. The provision of products sold and services performed by AGM Global Vision to the Customer shall not be interpreted, construed, or regarded, either expressly or implied, as being for the benefit of or creating any obligation toward any third party of legal entity outside AGM Global Vision and

the Customer; AGM Global Vision's obligations under this Agreement extend solely to the Customer. AGM Global Vision's liability hereunder for damages, regardless of the form or action, shall not exceed the fees or other charges paid to AGM Global Vision by the customer or customer's dealer. AGM Global Vision shall not, in any event, be liable for special, indirect, incidental, or consequential damages, including, but not limited to, lost income, lost revenue, or lost profit, whether such damages were foreseeable or not at the time of purchase, and whether or not such damages arise out of a breach of warranty, a breach of agreement, negligence, strict liability, or any other theory of liability.

4.1.3 PRODUCT REGISTRATION

In order to validate the warranty on your product, the customer must complete and submit AGM Global Vision PRODUCT REGISTRATION FORM on our website (www.agmglobalvision.com/customer-support).

4.1.4 OBTAINING WARRANTY SERVICE

To obtain warranty service on your unit, the End-user (Customer) must notify the AGM Global Vision service department via e-mail. Send any requests to support@agmglobalvision.com to receive a Return Merchandise Authorization number (RMA). When returning any device, please take the product to your retailer, or send the product, postage paid and with a copy of your sales receipt, to AGM Global Vision's service center at the address listed above. All merchandise must be fully insured with the correct postage; AGM Global Vision will not be responsible for improper postage or merchandise that becomes lost or damaged during shipment. When sending product back, please clearly write the RMA# on the outside of the shipping box. Please include a letter that indicates your RMA#, the Customer's Name, a Return Address, reason for the return, contact information (valid telephone numbers and/or an e-mail address), and proof of purchase that will help us to establish the valid start date of the warranty. Product merchandise returns that do not have an RMA# listed may be refused, or a significant delay in processing may occur. Estimated Warranty service time is 10-20 business days. The End-user/Customer is responsible for postage to AGM Global Vision for warranty service. AGM Global Vision will cover return postage/shipping after warranty repair to the End-user/Customer only if the product is covered by the aforementioned warranty. AGM Global Vision will return the product after warranty service by domestic UPS Ground service and/or domestic mail. Should any other requested, required, or international shipping methods be necessary, the postage/shipping fee will be the responsibility of the End-user/Customer.

For service, repair or replacement, please contact:

AGM Global Vision, LLC

173 West Main Street

PO Box 962

Springerville, AZ 85938

Tel. 928.333.4300

support@agmglobalvision.com

www.agmglobalvision.com

5 SPECIFICATIONS

5.1 SPECIFICATIONS

	RATTLER TC35-640	RATTLER TC50-640
Detector Type	12 μm VOx Uncooled Focal Plane Arrays	12 μm VOx Uncooled Focal Plane Arrays
Resolution	640x512	640x512
Refresh Rate	50 Hz	50 Hz
Response Waveband	8 μm to 14 μm	8 μm to 14 μm
Lens System	35 mm, F1.0	50 mm, F1.0
Field of View (HxV)	12.5° x 10.0°	8.8° x 7.0°
Magnification	1x	1x
Exit Pupil	22 mm	22 mm
Observation Distance	1,750 m	2,500 m
Monitor	1024x768, OLED, 50 Hz	1024x768, OLED, 50 Hz
Uniformity Correction (Flat Field Correction)	Auto, Manual, External Correction	Auto, Manual, External Correction
Palettes	Black Hot, White Hot, Red Hot, Fusion	Black Hot, White Hot, Red Hot, Fusion
Scene Mode	Jungle, Recognition	Jungle, Recognition
Distance Measurement	Stadiometric rangefinder	Stadiometric rangefinder
Highest Temperature Spot Tracking	Yes	Yes
Standby Mode	Yes	Yes
Built-in Storage	16 GB EMMC	16 GB EMMC
Record Video	On-board video recording	On-board video recording
Capture Snapshot	Yes	Yes
CVBS Output	Yes (via USB)	Yes (via USB)
Battery Type	Two CR123A Lithium (3V) or two RCR123 Rechargeable Batteries (up to 4.2V)	Two CR123A Lithium (3V) or two RCR123 Rechargeable Batteries (up to 4.2V)
Operating Time (25°C)	Up to 4.5 hours (WiFi off)	Up to 4.5 hours (WiFi off)
External Power Supply	5 VDC/2 A, USB Type-C	5 VDC/2 A, USB Type-C
Working Temperature	-20°C to 55°C (-4°F to 131°F)	-20°C to 55°C (-4°F to 131°F)
Protection Level	IP67	IP67
Shock and Vibration	750 g/ms	750 g/ms
Mounting	Optional Front Quick Release Adapters for different lens diameters or Quick Release Mount for Picatinny/Weaver rail	Optional Front Quick Release Adapters for different lens diameters or Quick Release Mount for Picatinny/Weaver rail
Dimensions	153 x 62 x 59 mm (6.0 x 2.4 x 2.3 in)	153 x 78 x 66 mm (6.0 x 3.1 x 2.6 in)
Weight (w/o batteries)	0.41 kg (0.92 lb)	0.49 kg (1.08 lb)

All data subject to change without notice.



AGM Global Vision, LLC

MAIN OFFICE

173 West Main Street

PO Box 962

Springerville, AZ 85938

USA

Tel. +1.928.333.4300

info@agmglobalvision.com

www.agmglobalvision.com

EUROPEAN OFFICE

#6 Andrey Lyapchev Blvd

Sofia, P.C. 1756

Bulgaria

Tel. +35.988.412.5573

info@agmglobalvision.eu

www.agmglobalvision.eu