

PROTECTOR

THERMAL IMAGING MONOCULAR

© 2021 AGM Global Vision, LLC. All rights reserved.

This documentation is subject to change without notice.

No parts of this manual, in whole or in part, may be copied, photocopied, translated, or transmitted by any electronic medium or in machine-readable form without the prior written permission of AGM Global Vision, LLC.

Approved for public release, distribution unlimited.

If you have questions that are not covered in this manual, or need service, contact AGM Global Vision customer support for additional information prior to returning a product.

AGM Global Vision, LLC

173 West Main Street

PO Box 962

Springerville, AZ 85938

Tel. 928.333.4300

support@agmglobalvision.com

www.agmglobalvision.com

EXPORT INFORMATION

Buyer acknowledges that all products supplied by AGM Global Vision, LLC are subject to U.S. export control laws, including, but not limited to, the Export Administration Regulations, the International Economic Emergency Powers Act, and various U.S. embargoes and sanctions. AGM Global Vision products may not be exported, re-exported, or transferred contrary to U.S. export control laws. In particular, AGM Global Vision products may not be exported, re-exported, or transferred to prohibited countries, individuals, organizations, or entities, including but not limited to those individuals and entities listed on the List of Specially Designated Nationals and Blocked Persons administered or maintained by the U.S. Office of Foreign Assets Control ("OFAC"), the various lists maintained by the Bureau of Industry and Security of the Department of Commerce, and the U.S. State Department and Buyer represents and warrants that neither Buyer nor any of its officers, directors, or employees are on such lists. Distribution or resale by Buyer to such countries, individuals, organizations, or entities is expressly prohibited. Buyer has and will maintain a positive process to ensure compliance with this Section.

LIST OF CONTENTS

TITLE	PAGE
Safety Summary	4
1. GENERAL INFORMATION	5
1.1 System Description	5
1.2 Standard Components	7
1.3 Optional Equipment	8
1.4 Key Features	9
2. OPERATING INSTRUCTIONS	10
2.1 Installation and Mounting	10
2.2 Controls and Display Indicators	13
2.3 Operating Procedures	18
3. MAINTENANCE INSTRUCTIONS	20
3.1 Troubleshooting	20
3.2 Maintenance	21
4. WARRANTY INFORMATION	22
4.1 Warranty Information and Registration	22
5. SPECIFICATIONS	24
5.1 Specifications	24
APPENDIX	26
A. Spare Parts List	26

SAFETY SUMMARY

- Read and follow all instructions
- Read all warnings
- Only use the attachments/accessories specified by the manufacturer
- All service must be provided by the manufacturer

WARNING:

This product contains natural rubber latex, which may cause allergic reactions! The FDA has reported an increase in the number of deaths associated with sensitivity to natural latex proteins. If you are allergic to latex, learn which products contain it and strictly avoid exposure to those products.

CAUTION:

- Do not dismantle the equipment.
- Keep the equipment clean. Protect it from moisture, dramatic temperature drops, and electrical shocks.
- DO NOT force the equipment controls past their stopping points.
- DO NOT leave the equipment activated during breaks in operation.
- DO NOT store the equipment with the batteries installed.
- Thoroughly clean and dry each item before placing them into the storage case.

CAUTION:

To prevent thermal damage to the equipment, never point it, either on or off, directly at the sun or any other source of high intensity light that the unprotected human eye cannot tolerate (such as a welding arc). To prevent inadvertent exposure to these types of sources, never leave the equipment with the objective lens cap off.

NOTES:

- To avoid losing unsaved data, DO NOT remove the batteries or disconnect the external power source while the Protector is on.
- Inadvertent sun damage is not considered a defect in material or workmanship, and is therefore not covered in the product warranty.

1 GENERAL INFORMATION

1.1 SYSTEM DESCRIPTION

The AGM Protector series represents a line of thermal imaging monoculars. A variety of objective lenses (25 mm, 50 mm, 75 mm) enable the operator to use the device as both a compact, pocket-sized thermal imaging monocular, or as a long-range observation tool.

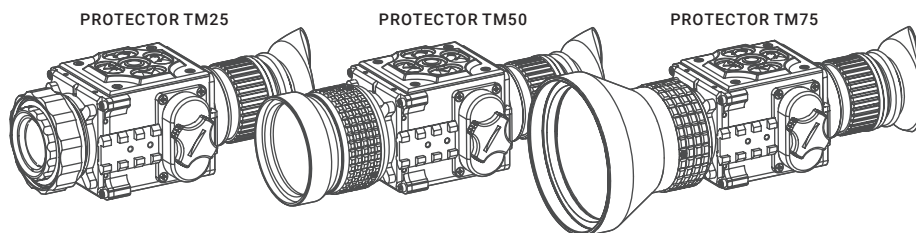

FIGURE 1-1. PROTECTOR SERIES THERMAL IMAGING MONOCULARS

The Protector is a thermosensitive device. The Protector senses the differences in heat emitted by objects in its field of view and converts the received temperature pattern into a viewable image that represents the scene in contrasting black and white or color patterns, depending on the user's selected image palette.

NOTE:

It is important that the Protector sensor receive sufficient thermal contrast between the object and background area, or between the different parts of an object. For example, there would be a vast temperature contrast between the snow and any heat object (such as an animal), making it exceptionally easy to distinguish the object.

All Protector series monoculars are based on 17 μ m uncooled cameras that allow for improvements in overall image quality in a wide range of dynamic thermal environments.

To accommodate individual user needs, the Protector has a variety of digitally controlled options such as:

- Display brightness, contrast, and sharpness
- Digital zoom
- Palette selection (color scheme)

Information on the current operating state (battery status, palette setting, etc.) is continuously displayed, making field operation of the Protector simple and convenient.

Manufactured for exceptional durability, the Protector has a lightweight and robust aluminum body.

The monocular is equipped with manual eyepiece and objective lens focusing. Two side Picatinny/Weaver rails allow for the installation of an optional HD Video Recorder, WiFi Attachment, Extended Battery Pack, or other equipment.

An universal input/output connector enables an external video display (monitor, TV) or video recorder to be connected to the Protector.

The Protector is powered by two CR123A (2×3V) batteries that gives up to 5 hours of continues work. An external 6VDC/600mA power source can be connected to the Protector. An external 5V power bank (battery pack) also can be easily connected via an micro-USB connector for a significant increase of operating time.

The Protector with 50mm lens is shown in Figure 1-2. The ITEM column of Table 1-1 indicates the number used to identify items in Figure 1-2.

NOTE:

Here and below, the model Protector with 50mm Lens is used for the example.

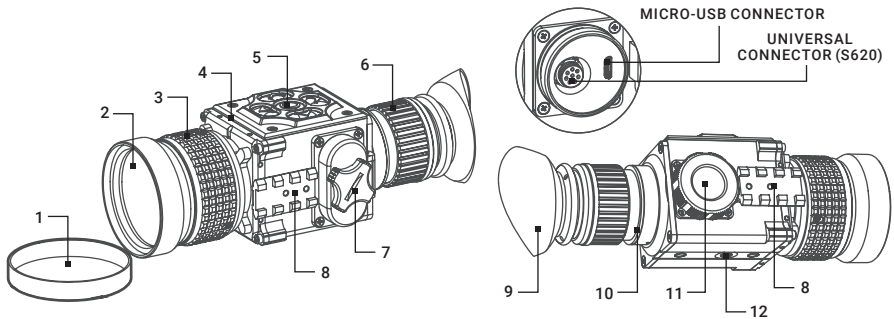

FIGURE 1-2. PROTECTOR MAIN PARTS

TABLE 1-1. PROTECTOR MAIN PARTS

ITEM	DESCRIPTION
1	Objective Lens Cap
2	Objective Lens
3	Objective Focus Ring
4	Body
5	Button Control Panel
6	Eyepiece Focus Ring

ITEM	DESCRIPTION
7	Battery Cap
8	Side Picatinny/Weaver Rail
9	Eyecup
10	Eyepiece Assembly
11	Connectors Cap
12	Tripod Socket

1.2 STANDARD COMPONENTS

The Protector standard components are shown in Figure 1-3 and listed in Table 1-2. The ITEM column indicates the number used to identify items in Figure 1-3.

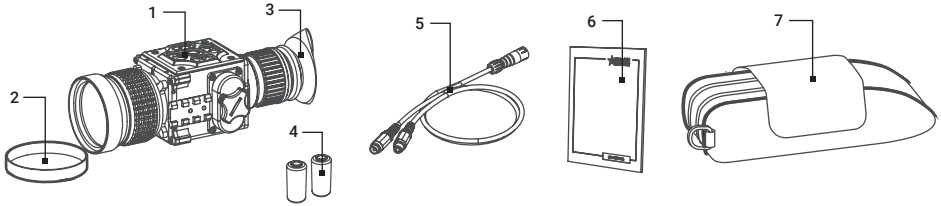

FIGURE 1-3. STANDARD COMPONENTS

TABLE 1-2. STANDARD COMPONENTS

ITEM	DESCRIPTION	QUANTITY
1	Protector Thermal Imaging Monocular	1
2	Objective Lens Cap	1
3	Eyecup	1
4	CR123A Lithium Battery	2
5	Video Cable	1
6	Operation Manual	1
7	Carrying Case	1

1.3 OPTIONAL EQUIPMENT

Optional items are shown in Figure 1-4 and listed in Table 1-3.

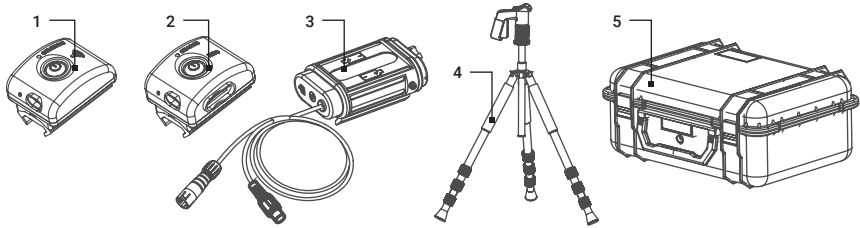

FIGURE 1-4. OPTIONAL EQUIPMENT

The ITEM column indicates the number used to identify items in Figure 1-4.

The PART NO. column indicates the primary number used by the manufacturer, to identify an item.

TABLE 1-3. OPTIONAL EQUIPMENT

ITEM	DESCRIPTION	PART NO.
1	AGM WiFi Attachment	6305WIF1
2	AGM HD Recorder	6305HDR1
3	AGM Extended Battery Pack	6308EXB1
4	Professional Titanium Tripod with a Grip	6606TTR1
5	Hard Case for Storage/Transportation	6610HCS1

1.4 KEY FEATURES

- Multiple versions with optical magnifications ranging from 1.25x to 3.75x
- High-performance thermal imaging camera
- Lightweight and robust design
- Easy to operate
- Manually adjustable eyepiece and objective lens
- Real-time display
- Digitally controlled features:
 - Image palette
 - Display brightness, contrast, and sharpness
 - Electronic magnification
 - Manual and Automatic Non-Uniformity Calibration (NUC)
 - Stadiametric rangefinder
 - Defective pixels repair
- Current operational state information display (battery status, palette setting, etc.)
- Analog video input and output
- Powered by two standard CR123A batteries
- Power input capability
- Digital HD Video Recorder (optional)
- External Wi-Fi module (optional)
- Serviceability under severe conditions
- Filled with dry nitrogen to prevent internal fogging
- Waterproof
- Limited 3-year warranty

2 OPERATING INSTRUCTIONS

2.1 INSTALLATION AND MOUNTING

2.1.1 BATTERIES INSTALLATION

CAUTION:

Verify that the equipment is OFF before remove the batteries.

To install the batteries (refer to Figure 2-1):

1. Turn the battery cover knob (A) counterclockwise and then open the battery cover (B).
2. Install two CR123A batteries (C) into the battery compartment. Align the polarity symbols on the batteries with the polarity symbols on the device body (D).
3. Close the battery cover. Turn the battery cover knob clockwise until stop.

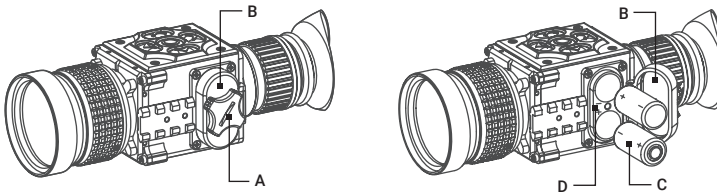

FIGURE 2-1. BATTERY INSTALLATION

When the device is on a battery charge level is displayed on the status bar (Figure 2-2).

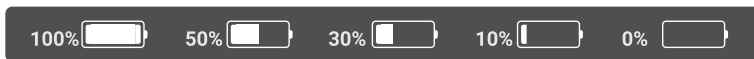

FIGURE 2-2. BATTERY STATUS BAR

WARNING:

Do not use rechargeable batteries since their use causes inaccurate battery level indication and possible disconnection during operation.

NOTE:

Please do not use batteries of different types or batteries with various charge levels.

2.1.2 INSTALLING AN ADDITIONAL EQUIPMENT

Use the side Picatinny/Weaver rails to install any additional equipment, such as the HD Video Recorder, WiFi Attachment, or the Extended Battery Pack.

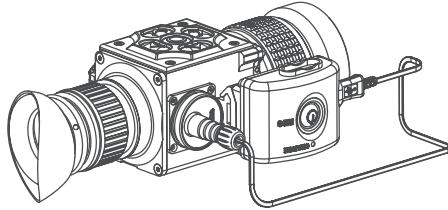

FIGURE 2-3. HD RECORDER INSTALLATION

2.1.3 CONNECTING AN ADDITIONAL EQUIPMENT

CAUTION:

Turn off the Protector before you begin connecting/disconnecting any external equipment and before removing the batteries.

Remove the connectors protective cap (see Figure 1-2).

Connect a cable of the external 5V battery bank to the Protector micro-USB connector.

Connect a cable of HD Video Recorder, WiFi Attachment, or the Extended Battery Pack to the Protector S620 universal connector.

Use the plug A (Figure 2-4) of a video cable to connect an external video recorder/monitor/TV to the Protector. Connect the plug C of a video cable to the Protector universal connector.

Use the plug B of a video cable to connect an external power source (6 VDC, 600 mA) to the Protector. Connect the plug C of a video cable to the Protector universal connector.

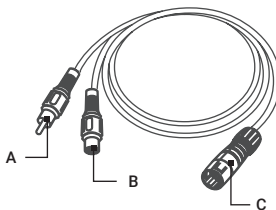

FIGURE 2-4. VIDEO CABLE

NOTE:

The external power supply must have a standard OD double-pole socket with a positive center contact.

CAUTION:

After removing the cable, replace the protective cap over the connector.

2.1.4 INSTALLING THE PROTECTOR ON A TRIPOD

To mount the Protector to a tripod, screw the tripod into the 1/4" threaded socket located on the bottom of the Protector.

CAUTION:

The unit may be badly damaged if the tripod collapses or falls over. Remove the unit from the tripod if it is not within your reach.

2.2 CONTROLS AND DISPLAY INDICATIONS

2.2.1 CONTROLS

CAUTION:

DO NOT force the equipment controls past their stopping points.

The Protector controls are shown in Figure 2-5 and are defined in Table 2-1. The ITEM column of the table indicate the numbers used to identify items in the figures.

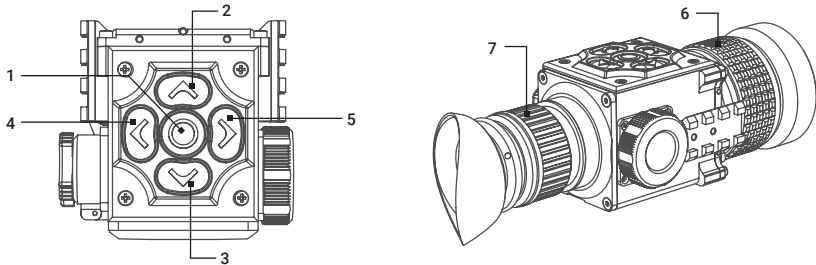

FIGURE 2-5. CONTROLS

TABLE 2-1. CONTROLS

ITEMS	CONTROLS	OPERATING MODE	FIRST SHORT PRESS	LONG PRESS
1	Central Button	Real Time Image	NUC	ON / OFF
		Quick Menu	Exit Quick Menu	
		Main Menu	Confirm selection	
2	Up Button	Real Time Image	NA	Enter Main Menu
		Quick Menu	Change parameters	
		Main Menu	Change parameters	
3	Down Button	Real Time Image	Bring out Quick Menu	NA
		Quick Menu	Change parameters	
		Main Menu	Change parameters	
4	Left Button	Real Time Image	Bring out Quick Menu	NA
		Quick Menu	Switch function	
		Main Menu	Select setting options	
5	Right Button	Real Time Image	Bring out Quick Menu	NA
		Quick Menu	Switch function	
		Main Menu	Select setting options	
6	Focus Ring	Focuses the objective lens for the sharpest image		
7	Eyepiece Focus Ring	Adjusts the diopter correction		

NOTE:

Various display symbols indicating the current operating state of the Protector can be displayed permanently, may appear momentarily, or can be set to appear only when a certain function is activated.

NOTE:

Each button is responsible for some functions selected by short press or long press the button. Pushing a button for 3+ second is considered “long press.”

2.2.2 STATUS BAR

The status bar is located in the lower part of the display (Figure 2-6) and shows information about an actual operating status of the sight, including:

1. Color palette: C1/C2/C3/... .
2. Distance to the object.
3. Current digital zoom magnification.
4. Battery charge with current level in percent.



FIGURE 2-6. STATUS BAR

2.2.3 QUICK MENU

The Quick Menu allows change of basic settings. Enter the Quick menu with a short press of any of the buttons Down/Left/Right. To toggle between the functions below, press Left or Right button when Quick menu is in display. Use Up and Down buttons to change the selected item. Press the central button to exit Quick Menu. If select of Zoom, Palette, Brightness, Contrast, Sharpness functions do not take place in 5 second, the information disappear from display.



MANUAL (SILENT) CALIBRATION

Close the lens cover before calibration.

There is a mechanical shutter between the camera sensor and the lens. This shutter is used to perform a non-uniformity calibration (NUC). During NUC, the shutter presents a uniform temperature source to each detector element in the array. While imaging the flat-field source, the camera updates the offset correction coefficients, resulting in a more uniform image after the process is complete. All Protector models allow for user to manually trigger or interrupt scheduled NUC function.



BRIGHTNESS

Press the Up/Down buttons to change image brightness from 0 to 9.



PALETTE

Basic image mode is “White Hot” (C1). Press the Up/Down buttons to select other palettes.



ZOOM

Press the Up/Down buttons to change digital zoom 1X/2X/4X/PIP.

Picture in inset window under PIP mode is 2X digital zoom.



CONTRAST

Press the Up/Down buttons to change display contrast from 0 to 9.



SHARPNESS

Select one of the sharpness aside (Normal/Smooth/Sharp) with a short press of Up / Down.



STADIAMETRIC RANGEFINDER

Protector monoculars are equipped with a stadiametric rangefinder which allows the user to estimate approximate distance to an object of known size.

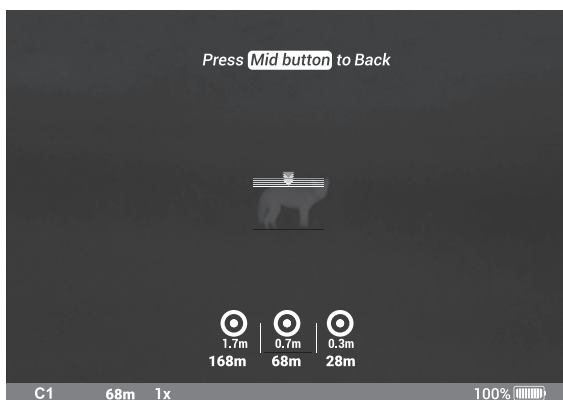

FIGURE 2-7. STADIAMETRIC RANGEFINDER

You will see on the display: measurement bars, icons of three reference objects and respective distances for the three objects.

There are three pre-set reference objects:

Object 1 - height 0.3 m

Object 2 - height 0.7 m

Object 3 - height 1.7 m

The lower fixed bar under the object automatically appear on display, press the Up/Down buttons to move the upper horizontal bar until the object fits entirely between the two lines. The distance to the object is automatically recalculated as you move the upper line.

Press Left/Right buttons to choose reference object, press Middle button to exit rangefinder mode, range information will not disappear from display automatically.

Distance to the object displays in status bar and a "> <" on reticle suggests the aiming point accordingly.

To select the unit of measurement (meters or yards), go to the respective menu option.

2.2.4 MAIN MENU

Enter the main menu with a long press of the Up button. Press the Left/Right buttons to select between the main menu options.

All menu is displayed in the central area of the image. The reason is the reduced field of view of the day sight by higher magnifications. Reaching a low battery state the device gives a warning in the top left corner of the central area.



EXIT

Press the Up/Down button to Exit, the Main Menu will not disappear automatically.



AUTO NUC

Press the Up/Down button to turn Automatic Non-Uniformity Calibration On/Off. In the automatic mode the need for calibration is based on software algorithm, calibration starts automatically. When choose Off, user will do calibration manually by either lens cover(silent without shutter) or press middle button(with shutter). Manual calibration function is in Quick Menu.



OLED BRIGHTNESS

Press the Up/Down buttons to change OLED brightness from 0, 1, 2.



UNIT

Press Up/Down to select units of measurement from Yards and Meters.





DEFECTIVE PIXEL REPAIR

Press Up/Down buttons then close lens cover to repair defective pixel. Defective pixels are found by software algorithm.



INFO

This option allows the user to view the following information about the imager.



RESET (RESTORE DEFAULT SETTING)

Press Up/Down buttons to Restore Default Setting, there will be no further indication. The following settings will be restored to their original values before changes made by user:

- Electronic Zoom
- Image Brightness
- Image Contrast
- Image Sharpness
- OLED Brightness

2.3 OPERATING PROCEDURES

2.3.1 OPERATING

CAUTION:

DO NOT force the equipment controls past their stopping points.

CAUTION:

To prevent thermal damage to the equipment, never point it, either powered or not, directly at the sun or any other source of high intensity light that the unprotected human eye cannot tolerate (such as a welding arc). To prevent inadvertent exposure to these sources, never leave the equipment without the objective lens cap secured.

Operating procedures are as follows:

1. Remove the Protector from the carrying case.
2. Remove the objective lens cap.
3. Point the equipment at an object.
4. Activate the Protector by long press the central button. After approximately 4 sec, video of the thermal scene should appear.
5. Adjust the Protector for your eyesight by turning the eyepiece focus ring CW up to the stop, and then CCW until the display and symbols (such as the reticle) are as clear as possible. Bring the object into focus by turning the objective focus ring (CW for far focus, CCW for near focus).
6. Using the QUICK MENU, configure the Protector to adapt it to your situation.

For more information on operational setting procedures, see Part 2.2 (Controls and Display Indications).

- A. Select the Image Palette.
- B. Adjust the image brightness, contrast, and sharpness for your comfort.
- C. Use digital zoom to magnify the central area of the displayed scene.

NOTE:

Digital zoom allows distant objects to appear larger; however, the resolution will be compromised.

- D. Use Manual Calibration (Non-Uniformity Calibration - NUC) function to improve image quality. As the camera including the detector heats up during the use, the detector pixels will drift. The pixels do not drift uniformly. The camera software compensates for the drift up to an accurate position point, but when the limit is reached the NUC function is triggered. A uniform mechanical shutter is placed between the lens and the detector for a moment and the signal is processed.

Push the central button to manually trigger a NUC.

7. Adjust the necessary adjustment using the MAIN MENU. See Part 2.2.2 (Using the MAIN MENU).

CAUTION:

DO NOT leave the equipment activated when not in use.

2.3.2 PROTECTOR SHUT-DOWN

NOTE:

Shut down the Protector properly to avoid losing unsaved settings and data.

Shut-down the Protector as follows:

1. Turn off the Protector.
2. Replace the cap on the objective lens.
3. Disconnect the cable (if applicable).
4. Place the cap on the connector.
5. Remove the batteries.

CAUTION:

Do not store the Protector with the batteries still in it.

6. Store the Protector and all accessories in the carrying case.

3 MAINTENANCE INSTRUCTIONS

3.1 TROUBLESHOOTING

The purpose of troubleshooting is to identify the most frequent equipment malfunctions, probable causes, and corrective actions required.

Table 3-1 lists the common malfunctions that may be found during the operation or maintenance of the Protector. Perform the tests/inspections and corrective actions in the order listed.

This table does not list all of the malfunctions that may occur with your device, or all of the tests and corrective actions that may be necessary. If you experience an equipment malfunction that is not listed, or is not fixed by the corrective actions listed in the table, please contact Customer Service center.

TABLE 3-1. TROUBLESHOOTING

MALFUNCTION	PROBABLE CAUSE/ TEST/ INSPECTION	CORRECTIVE ACTION
The monocular fails to activate.	Batteries are missing or improperly installed.	Insert batteries or install correctly.
	Batteries are dead.	Replace the batteries.
	Batteries, surfaces or contacts are dirty or corroded.	Clean the contact surfaces with a pencil eraser and/or alcohol and cotton swabs.
	The equipment is damaged.	Please contact Customer Support.
The monocular is not responsive to control buttons.	The equipment is damaged.	Please contact Customer Support.
Poor image quality.	Check objective lens and eyepiece focus.	Refocus.
	Check for fogging or dirt on objective lens and eyepiece.	Clean the lenses as detailed in Part 3.2.2.
	The equipment is damaged.	Please contact Customer Support.
No image on an external monitor.	Video cable is damaged.	Replace the video cable with a new one. Please contact Customer Support.
	The equipment is damaged.	Please contact Customer Support.
Light is visible around eyecup.	Check eyecup resilience.	If the eyecup is defective, please contact Customer Support.

3.2 MAINTENANCE

3.2.1 GENERAL

The Protector operator maintenance consists of operational tests, inspections for unit serviceability, cleaning and mounting procedures, corrective actions (troubleshooting and replacement of a limited number of parts). Maintenance instructions covered elsewhere in this manual (Troubleshooting, etc.) are not repeated in this section.

CAUTION:

The Protector is a precision electro-optical instrument and must be handled carefully at all times to prevent damage.

CAUTION:

DO NOT dismantle the equipment.

3.2.2 CLEANING PROCEDURES

Clean the Protector and optional items as follows:

1. Gently brush off any dirt from the equipment using only a clean, soft cloth.
2. Moisten the cloth with fresh water and gently wipe the external surfaces (except for optical surfaces).
3. Dry any wet surfaces (except for optical surfaces) with another clean, dry soft cloth.
4. Using a lens brush, carefully remove all loose dirt from optical surfaces (objective lens and eyepiece).
5. Slightly dampen a cotton swab with ethanol and lightly and slowly wipe optical surface. Clean the optical surface by circular movements from the center to the edge, not touching the lens holder and changing cotton swab after each circular stroke. Repeat until the optical surface is clean.
6. Clean the battery contact surfaces and contact springs with a pencil eraser and/or alcohol and cotton swabs.

CAUTION:

Thoroughly dry each item before replacing into the storage/carrying case.

4 WARRANTY INFORMATION

4.1 WARRANTY INFORMATION AND REGISTRATION

4.1.1 WARRANTY INFORMATION

This product is guaranteed to be free from manufacturing defects in material and workmanship under normal use for a period of three (3) years from the date of purchase. In the event that a defect covered by the warranty below occurs during the applicable period stated above, AGM Global Vision, at its discretion, will either repair or replace the product; such action on the part of AGM Global Vision shall be the full extent of AGM Global Vision's liability, and the Customer's sole and exclusive reparation. This warranty does not cover a product if it has been (a) used in ways other than its normal and customary manner; (b) subjected to misuse; (c) subjected to alterations, modifications or repairs by the Customer or by any party other than AGM Global Vision without prior written consent of AGM Global Vision; (d) is the result of a special order or categorized as "close-out" merchandise or merchandise sold "as-is" by either AGM Global Vision or the AGM Global Vision dealer; or (e) merchandise that has been discontinued by the manufacturer and either parts or replacement units are not available due to reasons beyond the control of AGM Global Vision. AGM Global Vision shall not be responsible for any defects or damage that in AGM Global Vision's view are a result from the mishandling, abuse, misuse, improper storage or improper operation of the device, including use in conjunction with equipment that is electrically or mechanically incompatible with, or of inferior quality to, the product, as well as failure to maintain the environmental conditions specified by the manufacturer. This warranty is extended only to the original purchaser. Any breach of this warranty shall be enforced unless the customer notifies AGM Global Vision at the address noted below within the applicable warranty period.

The customer understands and agrees that except for the foregoing warranty, no other warranties written or oral, statutory, expressed or implied, including any implied warranty of merchantability or fitness for a particular purpose, shall apply to the product. All such implied warranties are hereby and expressly disclaimed.

4.1.2 LIMITATION OF LIABILITY

AGM Global Vision will not be liable for any claims, actions, suits, proceedings, costs, expenses, damages, or liabilities arising out of the use of this product. Operation and use of the product are the sole responsibility of the Customer. AGM Global Vision's sole undertaking is limited to providing the products and services outlined herein in accordance with the terms and conditions of this Agreement. The provision of products sold and services performed by AGM Global Vision to the Customer shall not be interpreted, construed, or regarded, either expressly or implied, as being for the benefit of or creating any obligation toward any third party of legal entity outside AGM Global Vision and the Customer; AGM Global Vision's obligations under this Agreement extend solely to the Customer. AGM Global Vision's liability hereunder for damages, regardless of the form or action, shall not exceed the fees or other charges paid to AGM Global Vision by the customer or customer's dealer. AGM Global Vision shall not, in any event, be liable for special, indirect, incidental, or consequential damages, including, but not limited to, lost income, lost revenue, or lost profit, whether such damages were foreseeable or not at the time of purchase, and whether or not such damages arise out of a breach of warranty, a breach of agreement, negligence, strict liability, or any other theory of liability.

4.1.3 PRODUCT REGISTRATION

In order to validate the warranty on your product, the customer must complete and submit AGM Global Vision PRODUCT REGISTRATION FORM on our website (www.agmglobalvision.com/customer-support).

4.1.4 OBTAINING WARRANTY SERVICE

To obtain warranty service on your unit, the End-user (Customer) must notify the AGM Global Vision service department via e-mail. Send any requests to support@agmglobalvision.com to receive a Return Merchandise Authorization number (RMA). When returning any device, please take the product to your retailer, or send the product, postage paid and with a copy of your sales receipt, to AGM Global Vision's service center at the address listed above. All merchandise must be fully insured with the correct postage; AGM Global Vision will not be responsible for improper postage or merchandise that becomes lost or damaged during shipment. When sending product back, please clearly write the RMA# on the outside of the shipping box. Please include a letter that indicates your RMA#, the Customer's Name, a Return Address, reason for the return, contact information (valid telephone numbers and/or an e-mail address), and proof of purchase that will help us to establish the valid start date of the warranty. Product merchandise returns that do not have an RMA# listed may be refused, or a significant delay in processing may occur. Estimated Warranty service time is 10-20 business days. The End-user/Customer is responsible for postage to AGM Global Vision for warranty service. AGM Global Vision will cover return postage/shipping after warranty repair to the End-user/Customer only if the product is covered by the aforementioned warranty. AGM Global Vision will return the product after warranty service by domestic UPS Ground service and/or domestic mail. Should any other requested, required, or international shipping methods be necessary, the postage/shipping fee will be the responsibility of the End-user/Customer.

For service, repair or replacement, please contact:

AGM Global Vision, LLC

173 West Main Street

PO Box 962

Springerville, AZ 85938

Tel. 928.333.4300

support@agmglobalvision.com

www.agmglobalvision.com

5 SPECIFICATIONS

5.1 SPECIFICATIONS

TABLE 5-1. SPECIFICATIONS

	PROTECTOR TM25	PROTECTOR TM50	PROTECTOR TM75
Magnification	1.25x	2.5x	3.75x
Objective Lens Type	Germanium		
Detector Type	17µm Uncooled Microbolometer		
Frame Rate	50 Hz		
Resolution	384x288		
Display	HD Display 1024x768		
Turn-on Time, max	4 sec		
Digital Zoom	1x, 2x, 4x, PIP		
Temperature Imaging Modes (Image Palettes)	"White Hot", "Black Hot", and other color Image palettes		
Interfacing	<ul style="list-style-type: none"> • Micro-USB (Power bank 5V) • Universal S620 connector (Power In, Analog Video In/Out, Wi-Fi Attachment, HD Recorder, Extended Battery Pack) 		
Optical Data			
Objective Lens System	25 mm; F/1.0	50 mm; F/1.0	75 mm; F/1.0
Field of View (X × Y)	15.0° x 11.2°	7.5° x 5.6°	5.0° x 3.7°
Focusing Range	10 m to inf.		
Diopter Adjustment	Manual; ±5 diopter		
Electrical Data			
Battery	Two CR123A 3V Lithium batteries		
Battery Life at 20°C (68°F)	Up to 5 hr.		
External Power Supply	Power bank (5V) via Micro-USB port, Extended battery pack (additional operating time up to 8 hr.) or 6V/600 mA power supply via S620 universal connector		

	PROTECTOR TM25	PROTECTOR TM50	PROTECTOR TM75
Mechanical Data			
Overall Dimensions	195 x 70 x 58 mm (7.7 x 2.8 x 2.3 in)	225 x 70 x 64 mm (8.9 x 2.3 x 2.5 in)	250 x 93 x 93 mm (9.8 x 3.7 x 3.7 in)
Dimensions w/o Eyecup	145 x 70 x 82 mm (6.7 x 2.8 x 3.2 in)	175 x 70 x 82 mm (6.9 x 2.8 x 3.2 in)	200 x 89 x 100 mm (7.9 x 3.5 x 3.9 in)
Weight (w/o Batteries)	0.44 kg (0.83 lb)	0.55 kg (1.2 lb)	0.69 kg (1.5 lb)
Environmental Data			
Operating Temperature	-40°C to +50°C (-40°F to +122°F)		
Storage Temperature	-50°C to +70°C (-58°F to +158°F)		
Environmental Rating	IP67		

Specifications are subject to change without notice.

APPENDIX

A. SPARE PARTS LIST

The parts authorized by this list of spare parts are required for operator maintenance. The list includes parts that must be removed before replacing authorized parts.

The PART NO. column indicates the primary number used by the manufacturer, which controls the design and characteristics of the item in terms of its engineering drawings, specifications, standards, and inspection requirement, to identify an item.

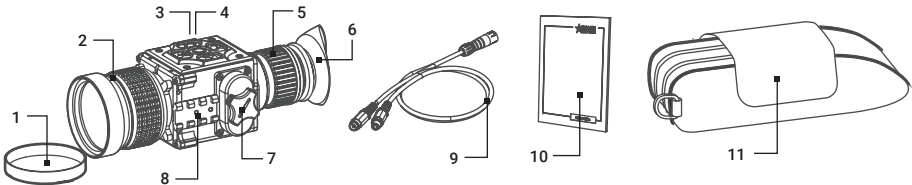

FIGURE A-1. PROTECTOR SPARE PARTS LIST

TABLE A-1. PROTECTOR SPARE PARTS LIST

ITEM	DESCRIPTION	PART NO.
1	25mm Objective Lens Cap	GOL25OBLCP
-	50mm Objective Lens Cap	GOL50OBLCP
-	75mm Objective Lens Cap	GOL75OBLCP
2	25mm Objective Lens Assembly	GOL25OBLAS
-	50mm Objective Lens Assembly	GOL50OBLAS
-	75mm Objective Lens Assembly	GOL75OBLAS
3	Connector Cap (not shown)	AGMTIDCNCP
4	Connector Cap Retainer (not shown)	AGMTIDCCR
5	Eyepiece Assembly	AGMPRTEPAS
6	Eyecup	AGMPRTECP
7	Battery Cap	AGMTIDBCP
8	Side Picatinny/Weaver Rail	AGMTIDSPR
9	Video Cable	AGMTIDVCB
10	Operation Manual	AGMPRTOM
11	Carrying Case	AGMPRTCC



AGM Global Vision, LLC

MAIN OFFICE

173 West Main Street

PO Box 962

Springerville, AZ 85938

USA

Tel. +1.928.333.4300

info@agmglobalvision.com

www.agmglobalvision.com

EUROPEAN OFFICE

Andrey Lyapchev #7

Sofia, P.C. 1756

Bulgaria

Tel. +35.988.412.5573

info@agmglobalvision.eu

www.agmglobalvision.eu