

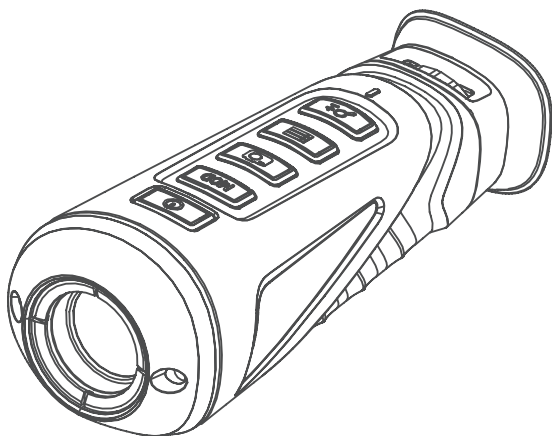

AGM
GLOBAL
VISION



ASP TM25-384 ASP TM35-384 ASP TM35-640

THERMAL IMAGING MONOCULARS

USER MANUAL

© 2019 AGM Global Vision. All rights reserved worldwide.

This documentation is subject to change without notice.

No parts of this manual, in whole or in part, may be copied, photocopied, translated, or transmitted by any electronic medium or in machine-readable form without the prior written permission of AGM Global Vision.

If you have questions that are not covered in this manual, or need service, contact AGM Global Vision customer support for additional information prior to returning a product.

AGM Global Vision

173 West Main Street

PO Box 962

Springerville, AZ 85938

Tel. 928.333.4300

Fax 480.393.4882

support@agmglobalvision.com

www.agmglobalvision.com

EXPORT INFORMATION

Buyer acknowledges that all products supplied by AGM Global Vision are subject to U.S. export control laws, including, but not limited to, the Export Administration Regulations, the International Economic Emergency Powers Act, and various U.S. embargoes and sanctions. AGM Global Vision products may not be exported, re-exported, or transferred contrary to U.S. export control laws. In particular, AGM Global Vision products may not be exported, re-exported, or transferred to prohibited countries, individuals, organizations, or entities, including but not limited to those individuals and entities listed on the List of Specially Designated Nationals and Blocked Persons administered or maintained by the U.S. Office of Foreign Assets Control ("OFAC"), the various lists maintained by the Bureau of Industry and Security of the Department of Commerce, and the U.S. State Department and Buyer represents and warrants that neither Buyer nor any of its officers, directors, or employees are on such lists. Distribution or resale by Buyer to such countries, individuals, organizations, or entities is expressly prohibited. Buyer has and will maintain a positive process to ensure compliance with this Section.

LIST OF CONTENTS

TITLE	PAGE
Safety Summary	4
1. GENERAL INFORMATION	5
1.1 System Description	5
1.2 Key Features	5
1.3 Standard Components	6
2. OPERATING INSTRUCTIONS	7
2.1. Basic Operations	7
2.2 Main Function	10
2.3 Client Software Introduction	15
3. MAINTENANCE INSTRUCTIONS	18
3.1 Maintenance	18
3.2 Troubleshooting	18
4. WARRANTY INFORMATION	20
4.1 Warranty Information and Registration	20
5. SPECIFICATIONS	22
5.1 Specifications	22

SAFETY SUMMARY

- Read and follow all instructions
- Read all warnings
- Only use the attachments/accessories specified by the manufacturer
- All service must be provided by the manufacturer

WARNING:

This product contains natural rubber latex, which may cause potentially fatal allergic reactions! If you are allergic to latex, it is important that you strictly avoid exposure to products that contain it.

WARNINGS AND CAUTIONS:

- All electronic operation should be in strict compliance with the electrical safety regulations, fire prevention regulations and other related regulations in your local region.
- Please use the power adapter, which is provided by a proven manufacturer. The power consumption cannot be less than the required value.
- Do not connect several devices to one power adapter as adapter overload may cause over-heat or fire hazard.
- Do not drop the device or subject it to physical shock, and do not expose it to high electromagnetism radiation. Avoid the device installation on vibrations surface or places subject to shock (ignorance can cause equipment damage).
- Do not place the device in extremely hot (refer to the specification of the device for the detailed operating temperature), cold, dusty or damp locations, and do not expose it to high electromagnetic radiation.
- The device cover for indoor use should be kept from rain and moisture.
- Exposing the device to direct sun light, low ventilation or heat source such as heater or radiator is forbidden (ignorance can cause fire danger).
- Do not aim the device at the sun or extra bright places. A blooming or smear may occur otherwise (which is not a malfunction however), and affecting the endurance of sensor at the same time.
- For long-term storage of the battery, make sure you fully charge it every 6 months, to ensure the battery quality. Otherwise, you may damage the battery.

NOTES:

The detector spectral band provides better visibility through smoke, dust, rain, smog, etc.

Infrared radiation does not travel through glass. As a result, the monocular does not detect objects if they are behind glass windows or other barriers.

1 GENERAL INFORMATION

1.1 SYSTEM DESCRIPTION

The Asp monocular is a handheld thermal camera with functions of observation, hot spot mark, distance measurement, Wi-Fi hotspot, and so on. The high-sensitivity built-in IR detector provides you with clear view even in total darkness.

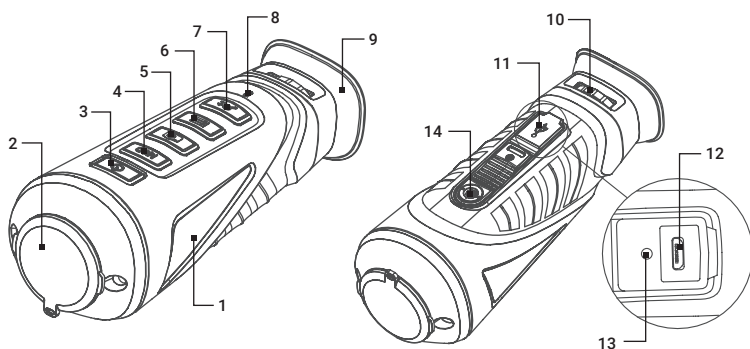

FIGURE 1-1. MAIN PARTS

TABLE 1-1. MAIN PARTS

ITEM	DESCRIPTION
1	Body
2	Lens Cap
3	POWER Button
4	MODE Button
5	CAPTURE Button
6	MENU Button
7	ZOOM Button

ITEM	DESCRIPTION
8	LED Indicator
9	Eyepiece
10	Focus Knob
11	USB Interface Cover
12	Micro-USB Interface
13	Battery Status Indicator
14	Tripod Screw

1.2 KEY FEATURES

- High sensitivity detector
- Adaptive AGC, Digital Detail Enhancement (DDE), 3D DNR
- 1024×768 resolution OLED display
- Distance measurement function
- The device detects and marks the hot spot of highest temperature
- A wide variety of color palettes
- Built-in memory supports video recording/snapshot capturing
- 1x, 2x, and 4x digital zoom
- Wi-Fi Hotspot
- Device can capture snapshots, record videos, and set parameters via APP after being connected to your phone with Wi-Fi hotspot
- Built-in rechargeable Li-Ion battery
- Up to five hours continuous running (with Wi-Fi hotspot function off)
- Limited 3-year warranty

1.3 STANDARD COMPONENTS

The standard components are shown in Figure 1-2 and listed in Table 1-2. The ITEM NO. column indicates the number used to identify items in Figure 1-2.

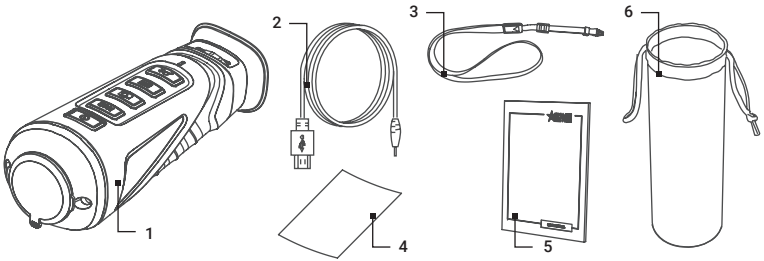

FIGURE 1-2. STANDARD COMPONENTS

TABLE 1-2. STANDARD COMPONENTS

ITEM NO.	DESCRIPTION	QUANTITY
1	Monocular	1
2	USB Cable	1
3	Lanyard	1
4	Lens Cloth	1
5	Operation Manual	1
6	Protective Bag	1

2 OPERATING INSTRUCTIONS

2.1. BASIC OPERATIONS

2.1.1 UNPACKING

The following steps must be completed prior to each mission.

1. Open the carrying case, remove the monocular, and verify that all components are included.
2. Inspect the monocular for any obvious evidence of damage to the optical surfaces, body, eyecup, operation buttons, etc. Ensure that all optical surfaces are clean and ready for use. Clean all optical surfaces with a lens tissue.

2.1.2 CHARGING THE MONOCULAR

NOTE:

Please charge the monocular with the delivered USB cable and power adapter. The charging temperature should be 0°C to 45°C (32°F to 113°F).

1. Lift the USB cover.

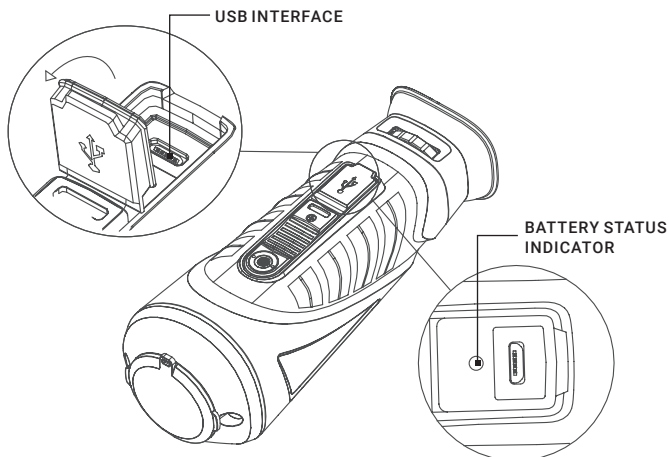

FIGURE 2-1. ASP TM-384 CHARGING

2. Plug in the USB cable and connect the other terminal into the power adapter.
3. Plug the power adapter to the power source.

When the monocular is turned on, the OSD (on-screen display) shows the battery status. When you see the Low Battery status, charge the monocular and ensure it's working properly.

TABLE 2-1. BATTERY LED INDICATOR STATUS

INDICATORS	FUNCTIONS
Red Flash	Error occurred.
Solid Red	Battery is properly charged.
Solid Green	Battery is fully charged.
Off	Battery is not charged.

2.1.3 BUTTONS

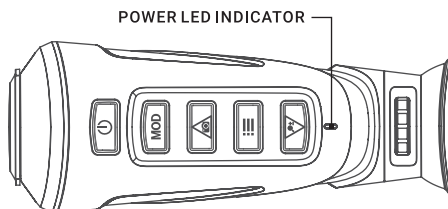







FIGURE 2-2. BUTTONS AND LED INDICATOR

TABLE 2-2. BATTERY LED INDICATOR STATUS

BUTTONS	FUNCTIONS
 POWER	Hold: Power On/Off
 MODE	Press: Switch Pallet Hold: Shutter Release
 CAPTURE	Press: Capture Snapshot Hold: Start/Stop Record Video Menu Navigation: Cursor Up
 MENU	Press: Sleep Mode Hold: Menu Operation Menu Navigation: Confirm
 ZOOM ±	Press: Digital Zoom Menu Navigation: Cursor Down

2.1.4 POWER ON AND OFF

Power On

Hold the POWER button for two seconds and the LED indicator in the front turns green. After the device is powered on, an image will appear on the display.

Refer to the figure below for the main view of the monocular.

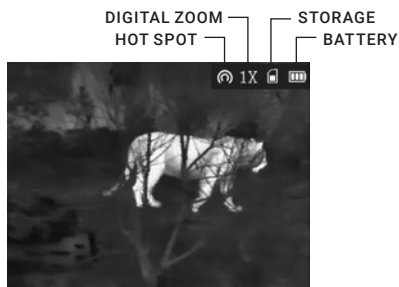

FIGURE 2-3. THE MAIN VIEW

Power Off

When the monocular is turned on, hold the POWER button for two seconds to power off the device.

2.1.5 THERMAL VIEW OBSERVATION

1. Power on the monocular.
2. Hold the monocular and make sure the eyepiece covers your eye.
3. Slide the focus knob to adjust the focus until the OSD text or image is clear.

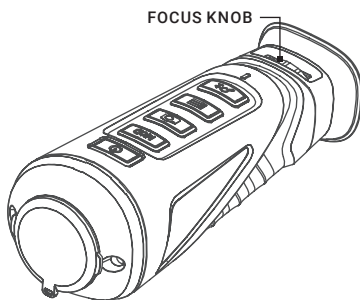

FIGURE 2-4. ASP TM-384 FOCUS KNOB





NOTE:

You must perform the focus adjustment before any further use of the monocular.

4. Point the monocular towards the target of the view.

2.1.6 USB PORT OPERATION

Connect the thermal monocular to your PC with USB cable, you can export the recorded videos and captured snapshots.

1. Hold the  button to enter the menu and select the  icon.
2. Press , the icon  turns on and the Wi-Fi hotspot function is disabled.
3. Connect the thermal monocular to your PC with USB cable, you can see a detected removable disk.

NOTES:

When you connect the device to PC for the first time, it installs the drive program automatically.

When you connect the device to PC, the device displays images, but functions such as recording, capturing and Wi-Fi hotspot are disabled.

File Export

1. Connect the thermal monocular to your PC with USB cable and open the detected disk.
2. Enter DCIM>100EZVIZ to view the videos and snapshots.
 - Select and copy the videos to PC and play the file with the player.
 - Select and copy the snapshots to PC and view the files.
3. Disconnect the device from your PC.

Upgrade

1. Connect the thermal monocular to your PC with USB cable and open the detected disk.
2. Copy the upgrade file and paste it to the root directory of the device.
3. Disconnect the device from your PC.
4. Reboot the monocular and the device upgrades automatically. The upgrading process will be displayed in the main interface.

2.2 MAIN FUNCTION

2.2.1 MENU OPERATION

When the monocular is turned on, hold the button  for three seconds to display the OSD menu.



FIGURE 2-5. THE MAIN MENU

































Press the button  to move the cursor up, and press the button  to move the cursor down. Press the button  to confirm.

TABLE 2-3. MENU FUNCTION

MENU	FUNCTION
 	Press  to display or hide the OSD information.
 	Press  to enable/disable hot spot mark (marking the spot of highest temperature).
 	Press  to enable or disable the Wi-Fi hotspot. Connect your phone to the monocular via the Wi-Fi hotspot and record/capture with App.
	Press  to enter distance measurement mode. For details, refer to Section 2.2.2 Distance Measurement.
  	Press  to adjust the brightness. The icons on the left indicate: high Brightness, medium Brightness, and low Brightness.
  	Press  to adjust the contrast. The icons on the left indicate: high contrast, medium contrast, and low contrast.
 	Press  to switch between the summer mode and winter mode.
	Press  to adjust the FFC mode to auto, manual, or external.
	Press  to correct dead pixel manually.
	Press  to view the version number and serial number.
	Press  to correct dead pixel manually.

Palette Settings

Under the same scene, you can select different palettes to see the scene in different effects.

TABLE 2-4. PALETTE SETTINGS

PALETTE	DESCRIPTION
WHITE HOT	The hot part is white-colored in view.
BLACK HOT	The hot part is black-colored in view.
FUSION	The hot part is yellow-colored and cold part is purple-colored in view.
RED HOT	The hot part is red-colored in view.

Brightness Adjusting

In white hot mode, you can adjust the brightness as  to adjust the image darker and darker.

In black hot mode, the brightness of the image turns in the opposite way.



FIGURE 2-6. BRIGHTNESS ADJUSTING

2.2.2 DISTANCE MEASUREMENT

Before you start:

In the view mode you can hold the  button to enter the menu and select  to enter the distance measurement mode.

Purpose:

You can mark the top and bottom of the target in the distance to calculate the distance between you and the target.











1. Enter the distance measurement mode. You can refer to **Before you start** part above.
2. Define the target height.
 - a) Press  to enter the height setting interface.
 - b) Press  and  to select the target from Deer, Wolf, Bear, and Custom.
 - c) Press  to confirm.
 - d) Press  and  to select the target height.
 - e) Press  to confirm.



FIGURE 2-7. DISTANCE MEASUREMENT

3. Set the top of the target.
 - a) Move the monocular slightly to place the  mark above the target top.
 - b) Press  to confirm.
4. Set the bottom of the target.

- a) Move the monocular slightly to place the  mark below the target bottom.
- b) Press  to confirm.



The distance between you and the target will display on the upper left corner of the live view interface.

NOTE:

Enter the distance measurement interface, press  to view the measured distance.

2.2.3 HOT SPOT MARK

In the menu, select  /  and press  to enable/disable hot spot mark (marking the spot of highest temperature).

When the hot spot mark is enabled, the  mark displays in the spot of the highest temperature. When the scene changes, the  mark moves.

2.2.4 RECORD/CAPTURE

Video Recording



In the view mode, hold the  button for three seconds, and the monocular starts to record. In the upper left corner, the recording time displays.



FIGURE 2-8. VIDEO RECORDING

After recording the video, hold the  button for three seconds again, and the monocular stops recording.

Snapshot Capturing

In the view mode, press the  button, the live view freezes for one second, and the snapshot is captured.

2.2.5 DIGITAL ZOOM

Press the  button in the view mode, the live view will switch between 1x digital zoom, 2x digital zoom, and 4x digital zoom.

2.2.6 SHUTTER RELEASE



In the view mode, press the  button once to release the shutter once.

2.2.7 FFC

Purpose:

FFC (Flat Field Correction) function can correct nonuniformity of display.

Steps:

1. Hold the  button to show the menu of monocular.
2. Press the  key.
3. Press the  button to switch the FFC mode.

Manual: Hold the  button in live view to correct the nonuniformity of display.

Auto: The monocular performs FFC automatically when switching on or rebooting the camera.

External: Cover the lens cover, then hold the  button in live view to correct the nonuniformity of display.

4. Hold the  button to confirm.







2.2.8 DPC

DPC (Defective Pixels Correction) function can correct the defective pixels on the screen which are not performed as expected.

Before you start:



Switch the palettes mode to white hot mode.

Steps:

1. Hold the  button to show the menu of monocular.
2. Press the  key.
3. Press the  to select the offset. The offset refers to the moving length of cursor.
4. Press  and  to select the moving direction.
5. Press  to move the cursor to the position of dead pixel.
6. Hold  to correct the dead pixel.

2.2.9 NETWORK CONFIGURATION

Connect your phone to the Wi-Fi hotspot of the monocular, you can configure the parameters and realize functions of the device.

1. Hold the  button to show the menu of monocular.
2. Press the  key to enable Wi-Fi hotspot function.
3. Turn on the WLAN and connect to the Wi-Fi hotspot.
 - Hotspot Name: Wlan-IPTS Serial No.
 - Hotspot Password: Serial No.
4. Search the client software on App Store (iOS System) or Google Play™ (Android System) to download and install the app.
5. Open the APP and connect your phone with the device. You can view the interface of monocular on your phone.

NOTE:

When the power is less than 15%, the Wi-Fi hotspot function will be turned off automatically.



2.3 CLIENT SOFTWARE INTRODUCTION

Before you start:

We recommend using T-Vision (V5.4.12 and below) software. Install the client software on your mobile phone first, and then connect your phone to the hotspot of the monocular. Refer to chapter 2.2.9 for details of hotspot connection.

NOTE:

The device password is set by user at first activation. If the password was lost or forgotten, it can be reset. To make a reset, provide the following action:

1. When the monocular is turned on, hold the button  for three seconds to activate the OSD menu.
2. Move the cursor to  and press the button  to restore all parameters to default settings.

Steps:

1. Open the APP and connect the phone or pad with the device.

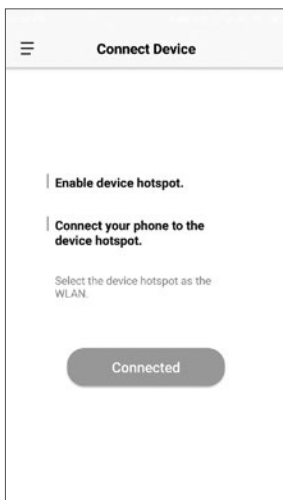

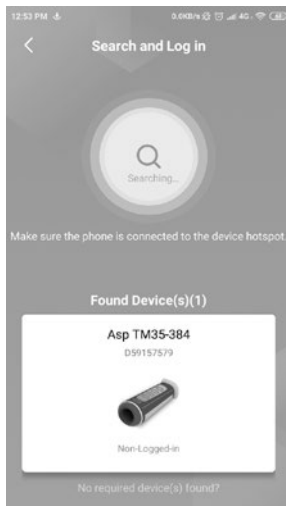

2. If the device is inactivated, set the password and activate it. If the device is activated, enter the password to add it to app.

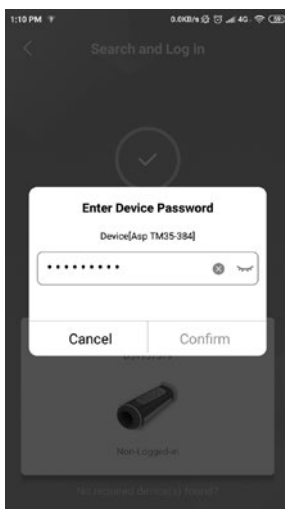

3. When the device is added, the live view can be seen. You can view the interface of the monocular on the software. User can change such image parameters as brightness, contrast, zoom, palettes directly via phone or pad as well as record video on phone/pad memory.



3 MAINTENANCE INSTRUCTIONS

3.1 MAINTENANCE

3.1.1 CLEANING PROCEDURES

1. Gently brush off any dirt from the body of the device using a clean, soft cloth.
2. Moisten the cloth with fresh water and gently wipe down the external surfaces (except lenses).
3. Dry any wet surfaces (except lenses) using another dry, clean, soft cloth.
4. Using a lens brush, carefully remove all loose dirt from the lenses.
5. Dampen a cotton swab with ethanol and slowly, gently wipe down the lenses. Clean the glass surfaces using circular movements, starting from the center of the lens and moving out towards the edge, without touching the lens holder. Change the cotton swab after each circular stroke. Repeat this step until the glass surfaces are clean.
6. Clean the accessories with a soft brush (or cloth) dampened with soap and water.

3.1.2 PREPARING FOR EXTENDED STORAGE

CAUTION:

Thoroughly dry each item before placing them into the storage case.

To prepare the monocular for extended storage:

1. Clean the monocular and accessories.
2. Place all items into the storage case.

3.2 TROUBLESHOOTING

Table 3-1 lists the most common malfunctions that may occur with your equipment. Perform the tests, inspections, and corrective actions in the order they appear in the table.

This table does not list all the malfunctions that may occur with your device, or all of the tests, inspections, and corrective actions that may be necessary to fix them. If the equipment malfunction is not corrected by the suggested actions, or a problem occurs that is not listed in this table, please contact AGM Global Vision's Customer Support center or your retailer.

TABLE 3-1. TROUBLESHOOTING

MALFUNCTION	CORRECTIVE ACTION
The charge indicator flashes improperly.	Examine whether the device is charged with standard power adapter and the charging temperature is 0°C to 45°C (32°F to 113°F).
Device power indicator is off.	Examine whether the device is off-battery.
The image of the monocular is not clear.	Perform the sight adjustment referring to section 2.1.5.
Wi-Fi is not found.	Examine whether the Wi-Fi function is turned on. If not, go to OSD menu and turn on Wi-Fi.
Capturing or recording fails.	<p>Examine the items below:</p> <ol style="list-style-type: none"> 1. Whether the device is connected to your PC and disabled the capturing and recording. 2. Whether the storage space is full. 3. Whether the device is low-battery.
The PC cannot identify the monocular.	<p>Examine the items below:</p> <ol style="list-style-type: none"> 1. Whether the device is connected to your PC with standard USB cable. 2. If you use other USB cables, make sure the cable length is no longer than 1m. 3. Whether the Wi-Fi function is turned on. If so, go to OSD menu and turn off Wi-Fi.

4 WARRANTY INFORMATION

4.1 WARRANTY INFORMATION AND REGISTRATION

4.1.1 WARRANTY INFORMATION

This product is guaranteed to be free from manufacturing defects in material and workmanship under normal use for a period of three (3) years from the date of purchase. In the event that a defect covered by the warranty below occurs during the applicable period stated above, AGM Global Vision, at its discretion, will either repair or replace the product; such action on the part of AGM Global Vision shall be the full extent of AGM Global Vision's liability, and the Customer's sole and exclusive reparation. This warranty does not cover a product if it has been (a) used in ways other than its normal and customary manner; (b) subjected to misuse; (c) subjected to alterations, modifications or repairs by the Customer or by any party other than AGM Global Vision without prior written consent of AGM Global Vision; (d) is the result of a special order or categorized as "close-out" merchandise or merchandise sold "as-is" by either AGM Global Vision or the AGM Global Vision dealer; or (e) merchandise that has been discontinued by the manufacturer and either parts or replacement units are not available due to reasons beyond the control of AGM Global Vision. AGM Global Vision shall not be responsible for any defects or damage that in AGM Global Vision's view are a result from the mishandling, abuse, misuse, improper storage or improper operation of the device, including use in conjunction with equipment that is electrically or mechanically incompatible with, or of inferior quality to, the product, as well as failure to maintain the environmental conditions specified by the manufacturer. This warranty is extended only to the original purchaser. Any breach of this warranty shall be enforced unless the customer notifies AGM Global Vision at the address noted below within the applicable warranty period.

The customer understands and agrees that except for the foregoing warranty, no other warranties written or oral, statutory, expressed or implied, including any implied warranty of merchantability or fitness for a particular purpose, shall apply to the product. All such implied warranties are hereby and expressly disclaimed.

4.1.2 LIMITATION OF LIABILITY

AGM Global Vision will not be liable for any claims, actions, suits, proceedings, costs, expenses, damages, or liabilities arising out of the use of this product. Operation and use of the product are the sole responsibility of the Customer. AGM Global Vision's sole undertaking is limited to providing the products and services outlined herein in accordance with the terms and conditions of this Agreement. The provision of products sold and services performed by AGM Global Vision to the Customer shall not be interpreted, construed, or regarded, either expressly or implied, as being for the benefit of or creating any

obligation toward any third party of legal entity outside AGM Global Vision and the Customer; AGM Global Vision's obligations under this Agreement extend solely to the Customer. AGM Global Vision's liability hereunder for damages, regardless of the form or action, shall not exceed the fees or other charges paid to AGM Global Vision by the customer or customer's dealer. AGM Global Vision shall not, in any event, be liable for special, indirect, incidental, or consequential damages, including, but not limited to, lost income, lost revenue, or lost profit, whether such damages were foreseeable or not at the time of purchase, and whether or not such damages arise out of a breach of warranty, a breach of agreement, negligence, strict liability, or any other theory of liability.

4.1.3 PRODUCT REGISTRATION

In order to validate the warranty on your product, the customer must complete and submit AGM Global Vision PRODUCT REGISTRATION FORM on our website (www.agmglobalvision.com/customer-support).

4.1.4 OBTAINING WARRANTY SERVICE

To obtain warranty service on your unit, the End-user (Customer) must notify the AGM Global Vision service department via e-mail. Send any requests to support@agmglobalvision.com to receive a Return Merchandise Authorization number (RMA). When returning any device, please take the product to your retailer, or send the product, postage paid and with a copy of your sales receipt, to AGM Global Vision's service center at the address listed above. All merchandise must be fully insured with the correct postage; AGM Global Vision will not be responsible for improper postage or merchandise that becomes lost or damaged during shipment. When sending product back, please clearly write the RMA# on the outside of the shipping box. Please include a letter that indicates your RMA#, the Customer's Name, a Return Address, reason for the return, contact information (valid telephone numbers and/or an e-mail address), and proof of purchase that will help us to establish the valid start date of the warranty. Product merchandise returns that do not have an RMA# listed may be refused, or a significant delay in processing may occur. Estimated Warranty service time is 10-20 business days. The End-user/Customer is responsible for postage to AGM Global Vision for warranty service. AGM Global Vision will cover return postage/shipping after warranty repair to the End-user/Customer only if the product is covered by the aforementioned warranty. AGM Global Vision will return the product after warranty service by domestic UPS Ground service and/or domestic mail. Should any other requested, required, or international shipping methods be necessary, the postage/shipping fee will be the responsibility of the End-user/Customer.

For service, repair or replacement, please contact:

AGM Global Vision

173 West Main Street

PO Box 962

Springerville, AZ 85938

Tel. 928.333.4300

Fax 480.393.4882

support@agmglobalvision.com

www.agmglobalvision.com

5 SPECIFICATIONS

5.1 SPECIFICATIONS

	ASP TM25-384	ASP TM35-384	ASP TM35-640
Image sensor	Vanadium Oxide Uncooled Focal Plane Arrays		
Detector Pitch	17um		
Response Wavebond	8um to 14um		
NETD	< 35mk (@25°C, F#=1.0)		
Refresh Rate	50 Hz		
Max. Resolution	384x288	384x288	640x512
Lens (Focal Length)	25mm	35mm	35mm
F number	1.0	1.0	1.0
Field of View	14.9° × 11.2°	10.7° × 8°	17.7° × 14.2°
Optical Magnification	1.7x	2.4x	1.4x
Digital Zoom	1x, 2x, 4x	1x, 2x, 4x	1x, 2x, 4x
Flat Field Correction	Auto, Manual, External Correction		
Palettes	Black hot, White hot, Red hot, Fusion		
Monitor	0.39-inch, OLED, 1024 × 768		
Hot Track	Yes		
Storage	Built-in memory module (16GB)		
Record Video	Support on-board video recording		
Capture Snapshot	Yes		
Wi-Fi	Yes, Hotspot		
Battery	Built-in rechargeable Lithium battery		
Operating Time	Up to 5 hours continuous running		
Battery Capacity Display	Yes		
Power	5V DC/2A, 2W		
Working Temperature	-30°C to 55°C (-22°F to 131°F)		
Protection Level	IP67		
Dimensions	189 × 74 × 66 mm (7.4 × 2.9 × 2.6 in)	202 × 74 × 66 mm (7.9 × 2.9 × 2.6 in)	202 × 74 × 66 mm (7.9 × 2.9 × 2.6 in)
Weight	460 g (16.2 oz)	480 g (16.9 oz)	480 g (16.9 oz)

*All data subject to change without notice.



AGM Global Vision

MAIN OFFICE

173 West Main Street

PO Box 962

Springerville, AZ 85938

USA

Tel. +1.928.333.4300

Fax +1.480.393.4882

info@agmglobalvision.com

www.agmglobalvision.com

EUROPEAN OFFICE

Andrey Lyapchev #7

Sofia, P.C. 1756

Bulgaria

Tel. +44.292.255.0509

info@agmglobalvision.eu

www.agmglobalvision.eu